

# RÓTULAS, BRAZOS DE SUSPENSIÓN Y BIELETAS

*ROTULES, BRAS DE SUSPENSION ET  
BIELLETES*

THE ROD ENDS, SUSPENSION ARMS AND  
CONNECTING RODS



**El uso de las marcas se hace exclusivamente con el propósito de indicar el modelo al que va destinada cada pieza**  
*Toute utilisation de marque n'est destinée qu'à qualifier le modèle de véhicule sur lequel elle doit être installée*  
The purpose of using the trade marks is exclusively to indicate the model of vehicle to which each part is assigned

**RÓTULAS, BRAZOS DE SUSPENSIÓN Y BIELETAS**
**ROTULES, BRAS DE SUSPENSION ET BIELLETES**
**TIE ROD ENDS, SUSPENSION ARMS AND CONNECTING RODS**

 Abreviaturas & símbolos  
 Abbreviations & symbols  
 Abréviations & symboles  
 Abreviaturas & símbolos

(E)	(E)	(GB)	(F)	(P)
← →	ambos lados	both sides	des deux côtés	Ambos os lados
←	izquierda	left side	à gauche	Esquerda
→	derecha	right side	à droite	Direita
↑	arriba	upper	hauteur	Em cima
↓	abajo	lower	en bas	Em baixo
↑↓	arriba-abajo	upper-lower	hauteur	Em cima-Em baixo
✱	centro	centre	milieu-en bas	Centro
# Cyl.	número de Cilindros	number of cylinders	quantité de cylindres	Numero de cilindros
[inch]	pulgada	inch	pouce	Pulgada
[mm]	milimetro	millimetres	millimètres	Milimetro
Ch N°  →	desde numero de chasis	from chassis number	à partir de/de numéro de châssis	Desde o numero de chassi
→  Ch N°	hasta numero de chasis	to chassis number	jusqu'a numéro de châssis	Até ao numero de chassi
4WD	traccion a todas las ruedas	4WD mode	type de transmission toutes roues	Taçção às 4 rodas
AC	acondicionador de aire	airconditioning	air conditionné	Ar condicionado
acero	acero	steel	acier	Aço
ajustable	ajustable	adaptable	ajustable	ajustable
agujeros	número de orificios	number of holes	nombre de trous	Numero de orificios
altura	altura	height	hauteur	Altura
aluminio	aluminio	aluminium	aluminium	Aluminio
ancho [mm]	ancho	width	largeur	Largura
armortiguador de dirección	armortiguador de dirección	steering damper	amortisseur de direction	Amortecedor de direção
AXLE	eje	axle	essieu	Eixo
barra de empuje	barra de empuje	pressure rod	barre de force	Barra de pressão
biela de empuje	biela de empuje	thrust arm	barre de force	Biela de pressão
brazo diagonal	brazo diagonal	inclined guide	guide incliné	Braço longitudinal
brazo guía	brazo guía	direction guide	bras oscillant transversal de direction	Braço de guia
brazo oscilante transversal	brazo oscilante transversal	stabilizer rod	bras de oscillant	Braço oscilante transversal
Bus	tipo de carrocería bus	bus	autobus/autocar	tipo de carroçaria bus
C [mm]	cono en mm	cone dimensions in mm	cône en mm	Cone em mm
caja/chassis	caja/chassis	platform/chassis	camion plate-forme/chassis à	caja/chassis
carga [Kg]	carga util [kg]	payload [kg]	charge utile [kg]	carga util [kg]
carga [Tn]	carga util [Tn]	payload [Tn]	charge utile [Tn]	carga util [Tn]
chasis rebajado	chasis rebajados	lowered chassis	châssis baissés	Chassis rebaixado
código de motor	código de motor	motor code	code moteur	código motor
diámetro de rueda Ø	diámetro de rueda	wheel diameter	diamètre de roue	Diâmetro da roda
Dir. Asistida	direccion asistida	power steering	direction assistée	Servo-direcção
Dir. Manual	caja de cambios manual	manual gearbox	boîte de vitesses	Caixa de velocidades
Dir. Manual/Dir. Asistida	tipo de dirección	steering type	type de direction	Tipo de direção
AUT	cambio automático	automatic gearbox	boîte de vitesses automatique	Caixa automática
Distancia entre agujeros	distancia entre orificios	pitch of holes	écartement des trous	Distancia entre os orificios
Espesor [mm]	espesor	thickness in mm	épaisseur	Espessura
estabilización activa	estabilización activa	active stabiliser	stabilisateur actif	estabilizador ativo
Excepto "XYZ"	sin "XYZ"	not for "XYZ"	sans/pas "XYZ"	sin "XYZ"
familiar	familiar	estate	break	Familiar
FWD	tracción a las ruedas delanteras	front wheel drive	roues motrices avant	Tracção dianteira
(FS)	Fin Stock	End of stock	une fin stock	fim stock
L-[mm]	longitud	length	longueur	longitud
L1/L2-[mm]	longitud1/longitud2	length1/length2	longueur1/longueur2	longitud1/longitud2
LHD	volante a la izquierda	left hand drive	véhicule à direction à gauche	volante esquerda
LHT	rosca a la izquierda	left hand thread	filet à gauche	rosca esquerda
medida de rosca	medida de rosca	thread size	dimension de filetage	Medida de rosca
Mod. 4WD	tracción integral	all wheel drive	traction intégrale	tracción integral
Mod. Quattro	tracción integral Quattro	all wheel drive Quattro	traction intégrale Quattro	tracción integral Quattro
Mod. carrocería	tipo de carrocería / Modelo	bearing type	type de carrosserie	tipo de carroçaria
Mod. Furgoneta	furgoneta	box	camionette	Furgoneta
Mod. Todo terreno	variante todo terreno	off road version	version tous-terrains	Variante todo terreno
Mod. 4-Matic	cambio automático 4-Matic	automatic gearbox 4-Matic	boîte de vitesses 4-Matic	Caixa automática 4-Matic
Nº piezas	número de piezas necesario	required quantity	nombre de pièces requises	Numero de peças necessárias
NO Mod "XYZ"	no/excepto para modelo "XYZ"	not for "XYZ"	sans/pas "XYZ"	sin "XYZ"
Ø [mm]:	diámetro	diameter	diametre	Diâmetro
Ø-ext:	diámetro exterior	external diameter	diamètre extérieur	Diâmetro exterior
Ø-taladro	taladro	bore	alésage	broca

## RÓTULAS, BRAZOS DE SUSPENSIÓN Y BIELETAS

## ROTULES, BRAS DE SUSPENSION ET BIELLETES

## TIE ROD ENDS, SUSPENSION ARMS AND CONNECTING RODS

Abreviaturas & símbolos  
Abbreviations & symbols  
Abréviations & symboles  
Abreviaturas & símbolos

(E)	(E)	(GB)	(F)	(P)
Orga N°  —>	desde N°  —> (Dia produccion)	from N°  —> (fabrication date)	à partir de N°  —> (jour fabrication)	Desde N°  —> (dia fabricação)
Orga N° —>	hasta N° —>  (Dia produccion)	to N° —>  (fabrication date)	jusqu'a N° —>  (jour fabrication)	Até N° —>  (dia fabricação)
RCH	chasis reforzado	chassis reinforcement	renforcement châssis	Reforço de chassi
REF-N°	número de referencia (OE)	reference number (OE No.)	numéro de référence (no OE)	Numero da referência Original
regulación de nivel	regulación de nivel	automatic level control system	correction d'assiette	Regulação de nivel
RHD	volante a la derecha	right hand drive	véhicule à direction à droit	volante direita
RHT	rosca a la derecha	right hand thread	filet à droite	Rosca direita
ROFM	limitación del fabricante	restriction of manufacturer	restrictions du fabricant	Limitação do fabricante
rotula de seguridad	rotula de seguridad	thrust rod	tige de compression	Rótula de sugurança
sedán	sedán	saloon	sedan	Sedan
Sistema DELPHI	sistema DELPHI	system DELPHI	système DELPHI	sistema DELPHI
Sistema SAGINAW	sistema SAGINAW	system SAGINAW	système SAGINAW	sistema SAGINAW
Sistema TRW	sistema TRW	system TRW	système TRW	sistema TRW
Sistema ZF	sistema ZF	system ZF	système ZF	sistema ZF
SP	suspensión deportiva	sports suspension	suspension sportive	Suspensão desportiva
Susp. normal	suspensión estándar	standard suspension	suspension norme	Suspensão padrão
Susp. rebajada	suspension rebajada	lowered suspension	suspension baissés	Suspensão rebaixada
Susp. deportiva	suspensión deportiva	sports suspension	suspension sportive	Suspensão desportiva
Susp. Off-Road	suspension todo-terreno	Off-Road suspension	suspension tout terrain	Suspensão todo terreno
Tamaño rueda	tamaño de llanta	rim size	dimension de la gante	Medida da jante
Tamaño rueda [inch]:	tamaño de llanta	rim size	dimension de la gante	Medida da jante
TAXI	variante taxi	taxi cab version	version taxi	Variante taxi
tipo de articulación	tipo de articulación	joint type	type de joint	Tipo de articulação
Tirante	tirante	guide rod	support guidage	Tirante
tirante sidán	tirante sidán	torque rod	tirant	Tirante
Todos los modelos	Todos los modelos	all models	tous les modèles	todos os modelos
Tubo-Ø [mm]:	diámetro de tubo	pipe diameter	diamètre de tube	diâmetro da tubulação
TYPO	tipo	type	type	tipo
Ver. reforzada	versión reforzada	hard version	une dure version	Duro
Y	no. de referencia. es parte de un juego de piezas	reference N°. Is part of a parts set	le no. de référence est une partie d'un assortiment de pièces	N° de referência é parte de um jogo de peças

**RÓTULAS, BRAZOS DE SUSPENSIÓN Y BIELETAS**

*ROTULES, BRAS DE SUSPENSION ET BIELLETES*

TIE ROD ENDS, SUSPENSION ARMS AND CONNECTING RODS

SUSPENSION, DIRECCION Y TRANSMISION / SUSPENSION, TRANSMISSION ET DIRECTION / SUSPENSION, TRANSMISSION AND STEERING

Estructuración del catálogo  
Catalogue layout  
Organisation du catalogue  
Disposição do catálogo

**Fabricante**

Manufacturer  
Constructeur  
Fabricante

**La Serie de modelos**

Model series  
La gamme modèles  
Série modelo

**Variantes de modelos**

Model series  
Variantes modèles  
Modelo diferentes

**Productos eje delantero**

Products front axle  
Produits essieu avant  
Productos eixo dianteiro

**Sector para una identificación detallada del producto**

Range for detailed identification of the product  
Secteur visant l'identification détaillée du produit  
Setor para identificação detalhada do produto

**Productos eje trasero**

Products rear axle  
Produits essieu arrière  
Productos eixo traseiro

**AUDI A4 / A4 AVANT / S4**  
**8D2/B5//8D5**

1	Conjunto dirección Steering unit Ensemble de direction Conjunto de direcção	←
2	Rótula dirección Steering ball joint Rotule de direction Rótula de direcção	←
3	Rótula axial Axial ball joint Rotule axiale Rótula axial	←
4	Brazo suspensión delantera superior trasero Upper rear front-suspension arm Bras de suspension avant supérieur arrière Braço suspensão dianteira superior traseira	← 1
5	Brazo suspensión delantera superior trasero Upper rear front-suspension arm Bras de suspension avant supérieur arrière Braço suspensão dianteira superior traseira	← 1
6	Brazo suspensión delantera superior delantero Upper front front-suspension arm Bras de suspension avant supérieur avant	← 1

**RÓTULAS, BRAZOS DE SUSPENSIÓN Y BIELETAS**

ROTULES, BRAS DE SUSPENSION ET BIELLETES

TIE ROD ENDS, SUSPENSION ARMS AND CONNECTING RODS

Catalogue layout  
Organisation du catalogue  
Disposição do catálogo

**LEMFÖRDER**

**01/1995 - 11/2000**

				REF.	
➤	<b>13678</b>	4D0 419 801B	01.07302.0	25863 21609	
➤	<b>25863</b>	4D0 419 811A/B/G	01.03645.1	13678	
➤	<b>21609</b>	4D0 422 821A	01.03646.1	13678	
➤	<b>21030</b>	4D0 407 509F/G/J	01.03761.0		
➤	<b>21029</b>	4D0 407 510F/G/J	01.03762.0		
				REF.	
➤	<b>13719</b>	8D0 407 505B/H/K			

**Año de fabricación**

Year of manufacture  
Année de construction  
Ano da manufatura

**Diseño representativo de la colocación de los productos**

Representative design of the positioning of the products  
Conception représentative du positionnement des produits  
Projeto representativo de posicionar dos produtos

**Numero de referencia**

Reference number  
Numéro de référence  
Número de referência

**Posición de colocación**

Assamby area  
Sectour d'assemblée  
Posicione a área

**Esta compuesta por ...**

Compose for ...  
Elle est composée par ...  
Está composta por ...

**El producto es adecuado para ...**

Product fits for ...  
Produit convient pour ...  
Ajustes do produto para ...

**Forma parte de ...**

Form part of ...  
Elle fait partie de ...  
Forma parte de ...

**Restricciones de producto (p. 2-3) / información sobre el producto**

Vehicle modification (P. 2-3) / product information  
Restriction de véhicule (p. 2-3) / information sur le produit  
Modificação do veículo (p. 2-3) / informação de produto

SUSPENSION, DIRECTION Y TRANSMISSION / SUSPENSION, TRANSMISSION ET DIRECTION / SUSPENSION, TRANSMISSION AND STEERING

**RÓTULAS, BRAZOS DE SUSPENSIÓN Y BIELETAS**
*ROTULES, BRAS DE SUSPENSION ET BIELLETES*

## TIE ROD ENDS, SUSPENSION ARMS AND CONNECTING RODS

07/1986 - 12/1998

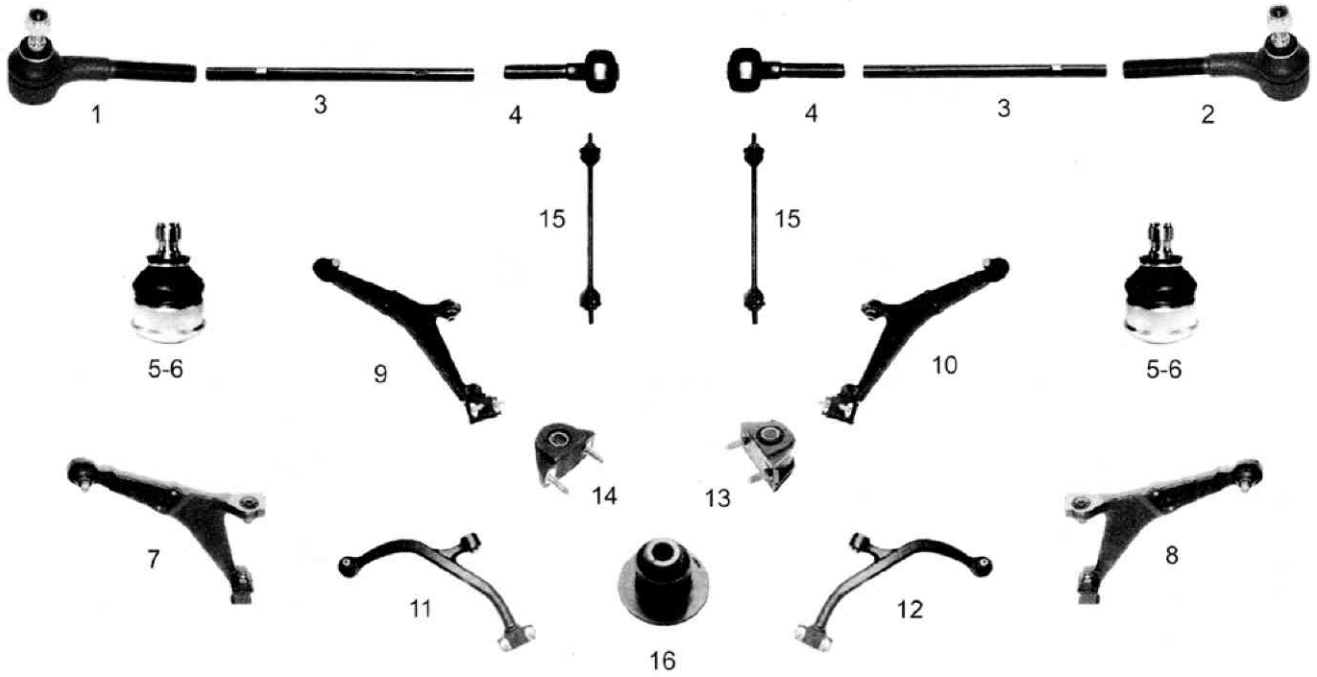











					REF. O.E.
1		Rótula dirección Steering ball joint Rotule de direction Rótula de direcção	←	Todos los modelos	<b>14799</b> 3817.41 01.03124.1
2		Rótula dirección Steering ball joint Rotule de direction Rótula de direcção	→	Todos los modelos	<b>14800</b> 3817.42 01.03125.1
3		Tirante dirección Steering brace Tirant de direction Tirante direcção	← →		<b>27979</b> 3812.A0/95609129 01.02209.0
4		Tirante dirección Steering brace Tirant de direction Tirante direcção	← →		<b>27980</b> 96 091 568 01.02197.0
5		Rótula suspensión inferior Lower suspension ball joint Rotule de suspension inférieure Rótula da suspensão inferior	← → ↓	Mod. 1.0/1.1/1.3/1.4/1.4D -->  04/1991 -->  Ch N° 5277	<b>11596</b> 95 603 309 01.03053.0 14794 14793
6		Rótula suspensión inferior Lower suspension ball joint Rotule de suspension inférieure Rótula da suspensão inferior	← → ↓	1992  --> Todos los modelos Ch N° 5278  -->	<b>15334</b> 96 093 233 01.50501.0 17434 17433 26736 ...
7		Brazo suspensión inferior Lower suspension arm Bras de suspension inférieur Braço da suspensão inferior	← ↓	06/1986 - 04/1991 Todos los modelos	<b>14793</b> 96 133 608 02.05117.0 11596
8		Brazo suspensión inferior Lower suspension arm Bras de suspension inférieur Braço da suspensão inferior	↓ →	06/1986 - 04/1991 Todos los modelos	<b>14794</b> 96 133 609 02.05116.0 11596

## RÓTULAS, BRAZOS DE SUSPENSIÓN Y BIELETAS

## ROTULES, BRAS DE SUSPENSION ET BIELLETES

## TIE ROD ENDS, SUSPENSION ARMS AND CONNECTING RODS

07/1986 - 12/1998







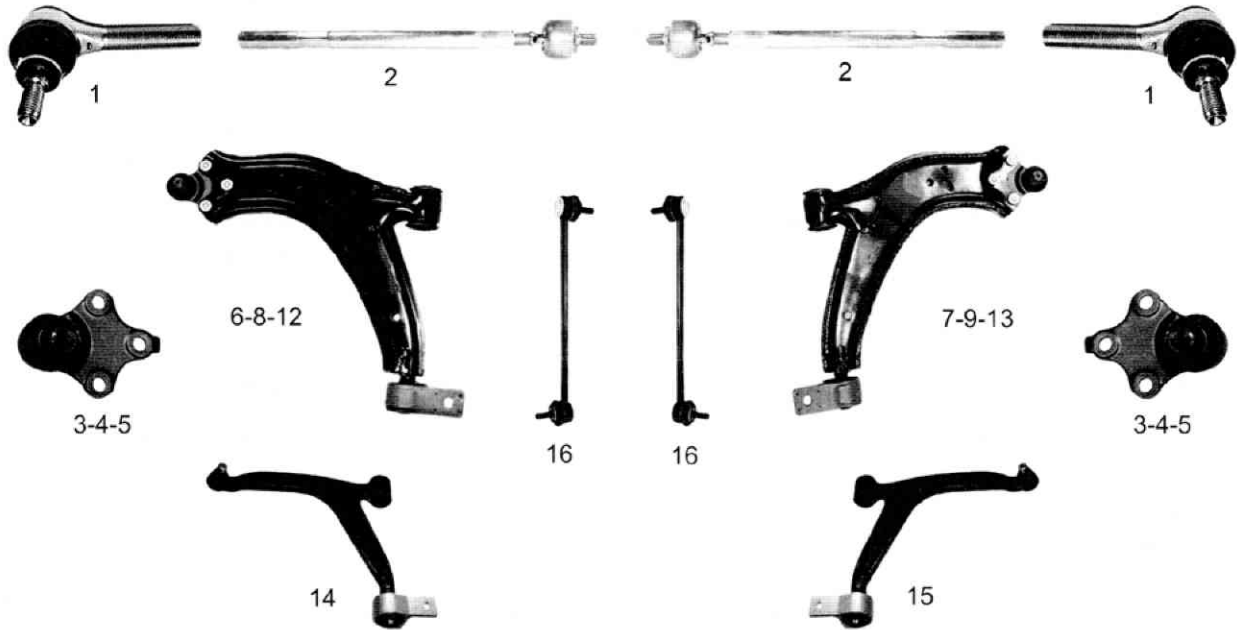

9		Brazo suspensión inferior Lower suspension arm Bras de suspension inférieur Braço da suspensão inferior	← ↓	Mod. 1.0/1.1/1.4/1.4D/1.5D 04/1991  -->	<b>17433</b> <b>02.05119.0</b>	95 658 978 15334 17452
10		Brazo suspensión inferior Lower suspension arm Bras de suspension inférieur Braço da suspensão inferior	→ ↓	Mod. 1.0/1.1/1.4/1.4D/1.5D 04/1991  -->	<b>17434</b> <b>02.05118.0</b>	95 658 979 15334 17452
11		Brazo suspensión inferior Lower suspension arm Bras de suspension inférieur Braço da suspensão inferior	← ↓	Mod. 1.4 GTI -->  Ch N° O 5990	<b>26736</b> <b>02.05214.0</b>	3520.92 15334 24515
12		Brazo suspensión inferior Lower suspension arm Bras de suspension inférieur Braço da suspensão inferior	→ ↓	Mod. 1.4 GTI -->  Ch N° O 5990	<b>26735</b> <b>02.05213.0</b>	3520.93 15334 24515
13		Soporte de goma (Silentblock) Rubber mounting Support en caoutchouc Suporte goma (Sino-bloco)	← →	Todos los modelos Excepto Mod. 1.4 GTI	<b>17452</b>	96 106 474 17433 17434
14		Silent-block brazo suspensión Silent-block arm support Silentbloc du bras de suspension Sino-bloco do braço da suspensão	← →	Mod. 1.4 GTI 07/1993  -->	<b>24515</b>	96 148 480 26736 26735
15		Bieleta estabilizadora delantera Front stabiliser rod Biellette de stabilisateur avant Biela estabilizadora dianteira	← →	Mod. 1.4 GTI	<b>19306</b> <b>01.02616.0</b>	96 147 514
			 			<b>REF. O.E.</b>
16		Soporte de cuerpo de eje Axle body mounting Support de corps de l'essieu Suporte goma corpo do eixo	← →	Mod. 14 4x4, 1.4 GTI	<b>22509</b>	5131 63

**RÓTULAS, BRAZOS DE SUSPENSIÓN Y BIELETAS**
**ROTULES, BRAS DE SUSPENSION ET BIELLETES**
**TIE ROD ENDS, SUSPENSION ARMS AND CONNECTING RODS**

07/1996 |--&gt;

MF\_M\_



					REF. O.E.
1		Rótula dirección Steering ball joint Rotule de direction Rótula de direcção	← → ↓	Todos los modelos Excepto 1.6 HDI 75/90kW	<b>12070</b> 3817.10 <b>01.00924.1</b>
2		Rótula axial Axial ball joint Rotule axiale Rótula axial	← →	Todos los modelos	<b>14792</b> 96048007581 <b>01.50504.0</b>
3		Rótula suspensión inferior Lower suspension ball joint Rotule de suspension inférieure Rótula da suspensão inferior	← → ↓	Ø16mm Dir. Mecanica y Dir. Asistida Ch Nº -->  7972	<b>14767</b> 3640.39/42/43 <b>01.50500.0</b> 17436 17435
4		Rótula suspensión inferior Lower suspension ball joint Rotule de suspension inférieure Rótula da suspensão inferior	← → ↓	Ø18mm Dir. Asistida Ch Nº 7973  -->	<b>25534</b> 3640.51 <b>01.02202.0</b> 28125 28126
5		Rótula suspensión inferior Lower suspension ball joint Rotule de suspension inférieure Rótula da suspensão inferior	← → ↓	Ø18mm Dir. Mecanica Ch Nº 7973  -->	<b>26047</b> 3640 50 <b>02.05628.0</b> <b>02.05629.0</b>
6		Brazo suspensión inferior (sin rótula) Lower suspension arm (NO ball joint) Bras de suspension inférieure (Sans Rotule) Braço da suspensão inferior (NO rótula)	← ↓	Todos los modelos	<b>27711</b> 3520.H3 <b>02.05568.0</b> 17435 28125
7		Brazo suspensión inferior (sin rótula) Lower suspension arm (NO ball joint) Bras de suspension inférieure (Sans Rotule) Braço da suspensão inferior (NO rótula)	→ ↓	Todos los modelos	<b>27712</b> 3521.E3 <b>02.05569.0</b> 17436 28126
8		Brazo suspensión inferior Lower suspension arm Bras de suspension inférieure Braço da suspensão inferior	← ↓	Ø16mm (O.E. brazo sin rotula) Dir. Manual y Dir. Asistida Todos los modelos -->  Ch Nº 7969	<b>17435</b> 3520.H8/H6/H5 <b>02.05121.0</b> 14767 27711











## RÓTULAS, BRAZOS DE SUSPENSIÓN Y BIELETAS

## ROTULES, BRAS DE SUSPENSION ET BIELLETES

## TIE ROD ENDS, SUSPENSION ARMS AND CONNECTING RODS

MF\_/M\_

07/1996 |--&gt;

9		Brazo suspensión inferior Lower suspension arm Bras de suspension inférieur Braço da suspensão inferior	→ ↓	Ø16mm (O.E. brazo sin rotula) Dir. Manual y Dir. Asistida Todos los modelos -->  Ch N° 7969	<b>17436</b> <b>02.05120.0</b>	3521.E8/E6/E5 14767 27712
10		Brazo suspensión inferior Lower suspension arm Bras de suspension inférieur Braço da suspensão inferior	← ↓	Ø18mm Dir Asistida Ch N° 7970-8364	<b>28125</b> <b>02.05390.0</b>	- 25534 27711
11		Brazo suspensión inferior Lower suspension arm Bras de suspension inférieur Braço da suspensão inferior	→ ↓	Ø18mm Dir Asistida Ch N° 7970-8364	<b>28126</b> <b>02.05391.0</b>	- 25534 27712
12		Brazo suspensión inferior Lower suspension arm Bras de suspension inférieur Braço da suspensão inferior	← ↓	Ø18mm Dir Manual Ch N° 7970  -->	<b>02.05629.0</b>	- 26047
13		Brazo suspensión inferior Lower suspension arm Bras de suspension inférieur Braço da suspensão inferior	→ ↓	Ø18mm Dir Manual Ch N° 7970  -->	<b>02.05628.0</b>	- 26047
14		Brazo suspensión inferior Lower suspension arm Bras de suspension inférieur Braço da suspensão inferior	← ↓	Mod. HDI PR 8365  -->	<b>26714</b> <b>02.05541.0</b>	3520.J3
15		Brazo suspensión inferior Lower suspension arm Bras de suspension inférieur Braço da suspensão inferior	→ ↓	Mod. HDI PR 8365  -->	<b>26715</b> <b>02.05540.0</b>	3521.E3
16		Bieleta estabilizadora delantera Front stabiliser rod Biellette de stabilisateur avant Biela estabilizadora dianteira	← →	Mod. 1.1/1.4/1.8/1.9D/2.0D	<b>11589</b> <b>01.02203.0</b>	5087.39/42/46





**RÓTULAS, BRAZOS DE SUSPENSIÓN Y BIELETAS**
*ROTULES, BRAS DE SUSPENSION ET BIELLETES*

## TIE ROD ENDS, SUSPENSION ARMS AND CONNECTING RODS

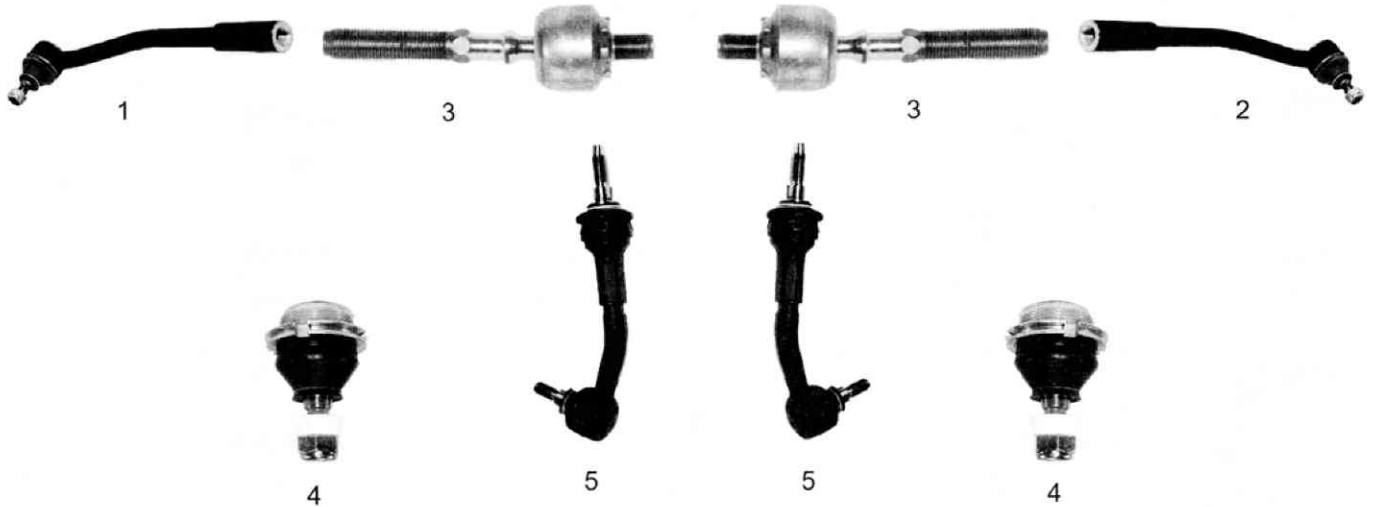
10/1982 - 09/1993

XB-



					REF. O.E.
1	 Rótula dirección Steering ball joint Rotule de direction Rótula de direcção	←	Todos los modelos L-273mm Ø14,5mm M14x1,5mm Rosca D	<b>11583</b> <b>01.03055.1</b>	95 496 044
2	 Rótula dirección Steering ball joint Rotule de direction Rótula de direcção	→	Todos los modelos L-273mm Ø14,5mm M14x1,5mm Rosca D	<b>11584</b> <b>01.03054.1</b>	95 496 045
3	 Rótula axial Axial ball joint Rotule axiale Rótula axial	← →	Todos los modelos L2-121mm M12x1/14x1,5mm	<b>11582</b> <b>01.03056.1</b>	95 495 440/439
4	 Rótula suspensión inferior Lower suspension ball joint Rotule de suspension inférieure Rótula da suspensão inferior	← → ↓	Todos los modelos Ø16mm	<b>11586</b> <b>01.03020.0</b>	3640.21
5	 Bieleta estabilizadora delantera Front stabiliser rod Bielle de stabilisateur avant Biela estabilizadora dianteira	← → ↓	Bieleta estabilizadora delantera	<b>11585</b> <b>01.50740.0</b>	95494821





## RÓTULAS, BRAZOS DE SUSPENSIÓN Y BIELETAS

ROTULES, BRAS DE SUSPENSION ET BIELLETES

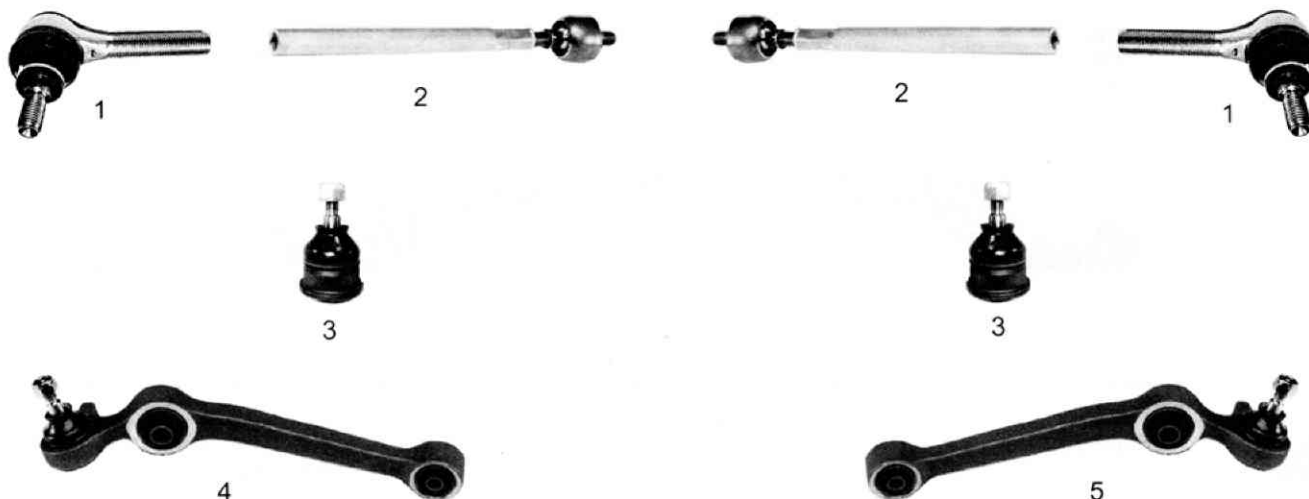
TIE ROD ENDS, SUSPENSION ARMS AND CONNECTING RODS

10/1984 - 12/1997











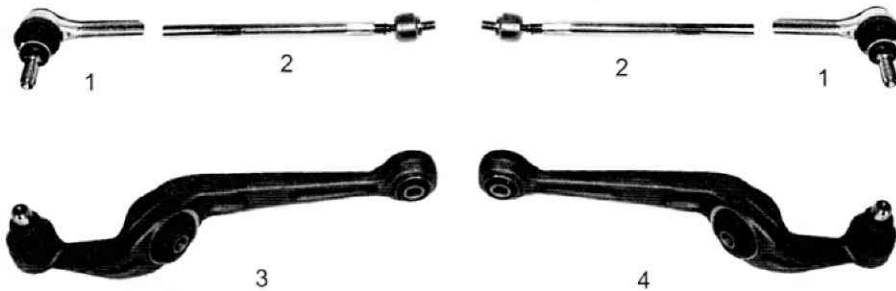





						REF. O.E.
1	 <p>Rótula dirección Steering ball joint Rotule de direction Rótula de direcção</p>	←	→	<p>Todos los modelos L-90mm Ø14,6mm M14x1,5mm Rosca D</p>	<p><b>12070</b> 01.00924.1</p>	3817.10
2	 <p>Rótula axial Axial ball joint Rotule axiale Rótula axial</p>	←	→	L2-263mm M12x1/M14x1,5mm	<p><b>12282</b> 01.00931.1</p>	-
3	 <p>Rótula suspensión inferior Lower suspension ball joint Rotule de suspension inférieure Rótula da suspensão inferior</p>	←	→	Ø14mm	<p><b>15613</b> 01.00053.0</p>	91 504 248
4	 <p>Brazo suspensión inferior Lower suspension arm Bras de suspension inférieur Braço da suspensão inferior</p>	←	↓		<p><b>17408</b> 01.00061.0</p>	91 504 358
5	 <p>Brazo suspensión inferior Lower suspension arm Bras de suspension inférieur Braço da suspensão inferior</p>		→	↓	<p><b>17409</b> 01.00060.0</p>	91 504 359

**RÓTULAS, BRAZOS DE SUSPENSIÓN Y BIELETAS**
*ROTULES, BRAS DE SUSPENSION ET BIELLETES*

## TIE ROD ENDS, SUSPENSION ARMS AND CONNECTING RODS

07/1986 - 12/1997



					REF. O.E.
1	 Rótula dirección Steering ball joint Rotule de direction Rótula de direcção	 	Todos los modelos L-90mm Ø14,6mm M14x1,5mm Rosca D		<b>12070</b> 3817.10 <b>01.00924.1</b>
2	 Rótula axial Axial ball joint Rotule axiale Rótula axial	 	L2-315mm M12x1/M14x1.5mm		<b>11658</b> 3812.95 <b>01.03041.1</b>
3	 Brazo suspensión inferior Lower suspension arm Bras de suspension inférieur Braço da suspensão inferior	 	Mod. 1.1/1.4/1.8D Ø16mm		<b>12064</b> 91 516 336 <b>01.03043.0</b> 19247
4	 Brazo suspensión inferior Lower suspension arm Bras de suspension inférieur Braço da suspensão inferior	 	Mod. 1.1/1.4/1.8D Ø16mm		<b>12065</b> 91 516 337 <b>01.03042.0</b> 19247







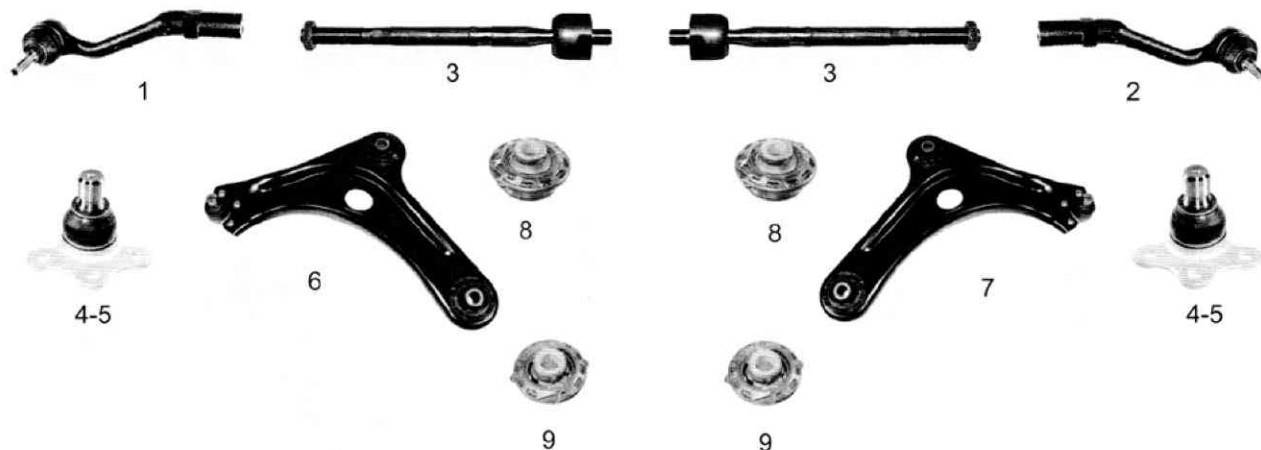

## RÓTULAS, BRAZOS DE SUSPENSIÓN Y BIELETAS

### ROTULES, BRAS DE SUSPENSION ET BIELLETES

#### TIE ROD ENDS, SUSPENSION ARMS AND CONNECTING RODS

09/2003 |-->



					REF. O.E.
1	 Rótula dirección Steering ball joint Rotule de direction Rótula de direcção	←			<b>25505</b> 3817.55 <b>01.02582.0</b>
2	 Rótula dirección Steering ball joint Rotule de direction Rótula de direcção		→		<b>25506</b> 3817.56 <b>01.02583.0</b>
3	 Rótula axial Axial ball joint Rotule axiale Rótula axial	←	→		<b>25507</b> 3812.E1 <b>01.02584.0</b>
4	 Rótula suspensión inferior Lower suspension ball joint Rotule de suspension inférieure Rótula da suspensão inferior	←	→	Orga Nº -->  10562 No reforzado -->  09/2005 Para chasis estandar Mod: 1.1, 1.4, 1.6 y 1.4 Hdi.	<b>30452</b> 3640 61 29596 29597
5	 Rótula suspensión inferior Lower suspension ball joint Rotule de suspension inférieure Rótula da suspensão inferior	←	→	Orga Nº -->  10562 Mod: 1.6 VTS	<b>30453</b> 3640 59
6	 Brazo suspensión inferior delantero Lower front suspension arm Bras de suspension inférieur avant Braço da suspensão inferior dianteira	←	↓	Rot. 28972 Orga Nº -->  10562 No reforzado -->  09/2005 Para chasis estandar Mod: 1.1, 1.4, 1.6 y 1.4 Hdi.	<b>29596</b> 3520 L9 30452 29529 29530
7	 Brazo suspensión inferior delantero Lower front suspension arm Bras de suspension inférieur avant Braço da suspensão inferior dianteira		→	Rot. 28972 Orga Nº -->  10562 No reforzado -->  09/2005 Para chasis estandar Mod: 1.1, 1.4, 1.6 y 1.4 Hdi.	<b>29597</b> 3521 J1 30452 29529 29530
8	 Silent-block brazo suspensión Silent-block arm support Silentbloc du bras de suspension Sino-bloco do braço da suspensão	←	→	Mod: 1.1, 1.4, 1.6 y 1.4 Hdi	<b>29529</b> 3523 98 29596 29597
9	 Silent-block brazo suspensión Silent-block arm support Silentbloc du bras de suspension Sino-bloco do braço da suspensão	←	→	Mod: 1.1, 1.4, 1.6 y 1.4 Hdi	<b>29530</b> 3523 AA 29596 29597

**RÓTULAS, BRAZOS DE SUSPENSIÓN Y BIELETAS**
**ROTULES, BRAS DE SUSPENSION ET BIELLETES**
**TIE ROD ENDS, SUSPENSION ARMS AND CONNECTING RODS**

02/2002 |--&gt;

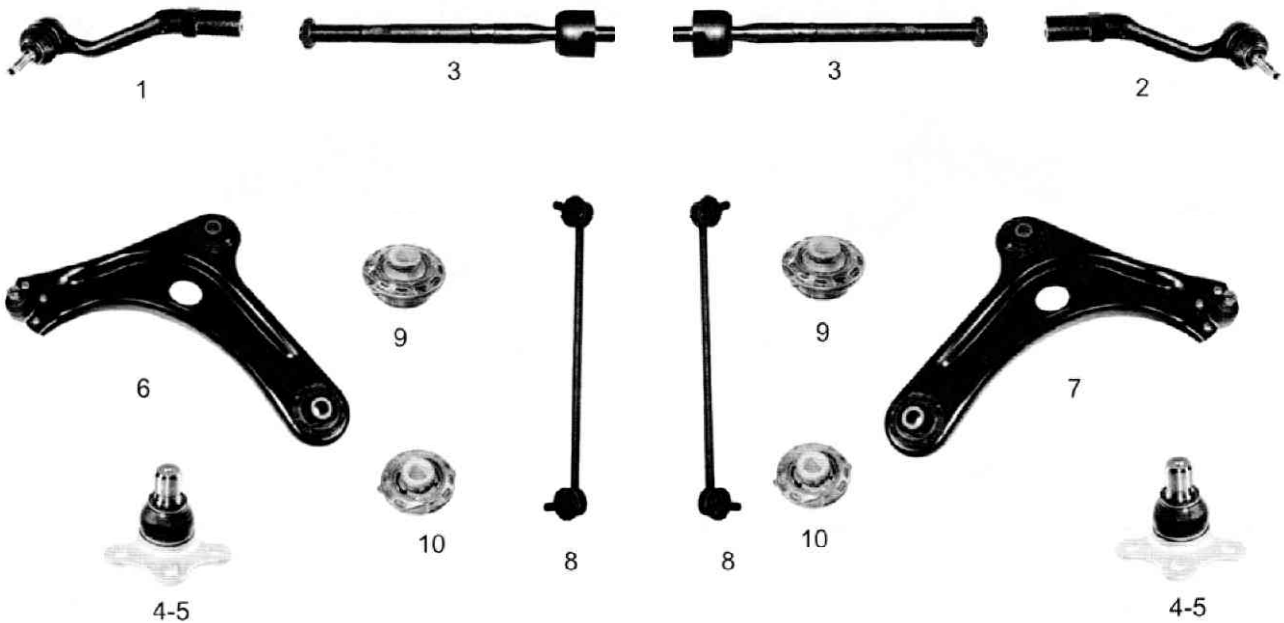



					REF. O.E.
1	Rótula dirección Steering ball joint Rotule de direction Rótula de direcção	←	Todos los modelos Excepto 1.4 16V, 1.6 16V HDI L-170mm Ø15mm M14x1,5mm Rosca D	<b>25505</b> 01.02582.0	3817.55
2	Rótula dirección Steering ball joint Rotule de direction Rótula de direcção	→	Todos los modelos Excepto 1.4 16V, 1.6 16V HDI L-170mm Ø15mm M14x1,5mm Rosca D	<b>25506</b> 01.02583.0	3817.56
3	Rótula axial Axial ball joint Rotule axiale Rótula axial	← →	Todos los modelos L2-235mm M12x1/14x1,5mm	<b>25507</b> 01.02584.0	3812.E1
4	Rótula suspensión superior Upper suspension ball joint Rotule de suspension supérieure Rótula da suspensão superior	← → ↑	Ø18mm Todos los modelos Orga Nº -->  10562	<b>30451</b>	3640.56 28965 28966
5	Rótula suspensión inferior Lower suspension ball joint Rotule de suspension inférieure Rótula da suspensão inferior	← → ↓	Ø16mm Orga Nº -->  10562 Mod. 1.4 16V, 1.6 16V, 1.6 16V HDI	<b>30453</b>	3640.59
6	Brazo suspensión inferior delantero Lower front suspension arm Bras de suspension inférieur avant Braço da suspensão inferior dianteira	← ↓	Todos los modelos -->  03/2004 No reforzado Chasis estandar Orga Nº -->  10002 Excepto 1.6 16V Hdi.	<b>28965</b>	3520 L4 30451 29529 29530
7	Brazo suspensión inferior delantero Lower front suspension arm Bras de suspension inférieur avant Braço da suspensão inferior dianteira	→ ↓	Todos los modelos -->  03/2004 No reforzado Chasis estandar Orga Nº -->  10002 Excepto 1.6 16V Hdi.	<b>28966</b>	3521 H6 30451 29529 29530
8	Bieleta estabilizadora delantera Front stabiliser rod Bielle de stabilisateur avant Biela estabilizadora dianteira	← →	Todos los modelos	<b>22651</b> 01.02309.0	5087.45

**RÓTULAS, BRAZOS DE SUSPENSIÓN Y BIELETAS**

*ROTULES, BRAS DE SUSPENSION ET BIELLETES*

TIE ROD ENDS, SUSPENSION ARMS AND CONNECTING RODS

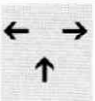
02/2002 |-->

9		<p>Silent-block brazo suspensión                      Silent-block arm support                      Silentbloc du bras de suspension                      Sino-bloco do braço da suspensão</p>		<p>Todos los modelos                      Excepto 1.6 16V Hdi.</p>	<p><b>29529</b></p>	<p>3523 98</p>	<p>28965                      28966</p>
10		<p>Silent-block brazo suspensión                      Silent-block arm support                      Silentbloc du bras de suspension                      Sino-bloco do braço da suspensão</p>		<p>Orga N° --&gt;  10562                      Mod. 1.4 i, 1.4 16V, 1.4 HDI, 1.6                      16V Hdi.</p>	<p><b>29530</b></p>	<p>3523 AA</p>	<p>28965                      28966</p>

**RÓTULAS, BRAZOS DE SUSPENSIÓN Y BIELETAS**
**ROTULES, BRAS DE SUSPENSION ET BIELLETES**
**TIE ROD ENDS, SUSPENSION ARMS AND CONNECTING RODS**

11/2004 |--&gt;

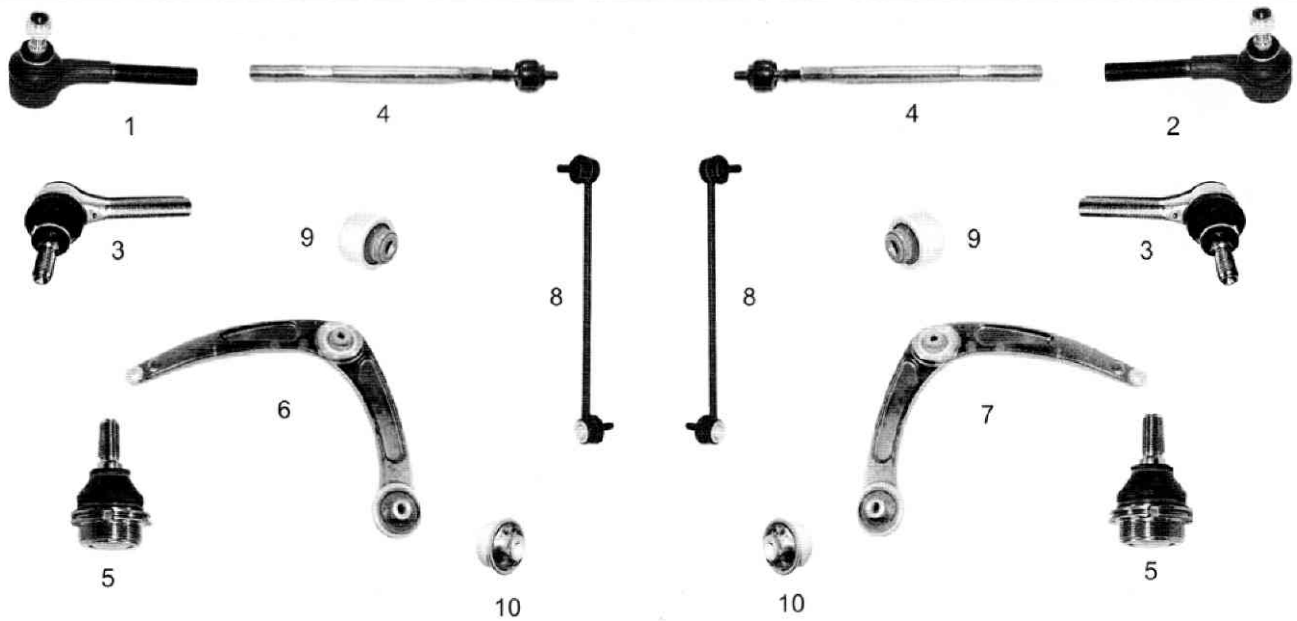

					REF. O.E.
1	Rótula dirección Steering ball joint Rotule de direction Rótula de direcção	←	L-114mm Ø14,6mm M14x1,5mm Rosca D Ch N° -->  10310	<b>14799</b> 01.03124.1	3817.41
2	Rótula dirección Steering ball joint Rotule de direction Rótula de direcção	→	L-114mm Ø14,6mm M14x1,5mm Rosca D Ch N° -->  10310	<b>14800</b> 01.03125.1	3817.42
3	Rótula dirección Steering ball joint Rotule de direction Rótula de direcção	← →	L-90mm Ø14,6mm M14x1,5mm Rosca D Ch N° 10311  -->	<b>12070</b> 01.00924.1	3817.50
4	Rótula axial Axial ball joint Rotule axiale Rótula axial	← →	L2-325mm M14x1,5/14x1,5mm -->  Ch N° 10310	<b>26059</b> 01.02576.0	3812.E0
5	Rótula suspensión inferior Lower suspension ball joint Rotule de suspension inférieure Rótula da suspensão inferior	← → ↓	Ø18mm Todos los modelos	<b>27299</b> 01.02577.0	3640.60
6	Brazo suspensión inferior Lower suspension arm Bras de suspension inférieure Braço da suspensão inferior	← ↓		<b>30606</b>	3520 P3 28898 28899
7	Brazo suspensión inferior Lower suspension arm Bras de suspension inférieure Braço da suspensão inferior	→ ↓		<b>30607</b>	3521 K3 28898 28899
8	Bieleta estabilizadora delantera Front stabiliser rod Bielle de stabilisateur avant Biela estabilizadora dianteira	← →	L-335mm M10x1,5mm Todos los modelos	<b>26653</b>	5087.50





**RÓTULAS, BRAZOS DE SUSPENSIÓN Y BIELETAS**

*ROTULES, BRAS DE SUSPENSION ET BIELLETES*

TIE ROD ENDS, SUSPENSION ARMS AND CONNECTING RODS

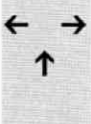

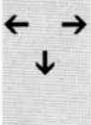

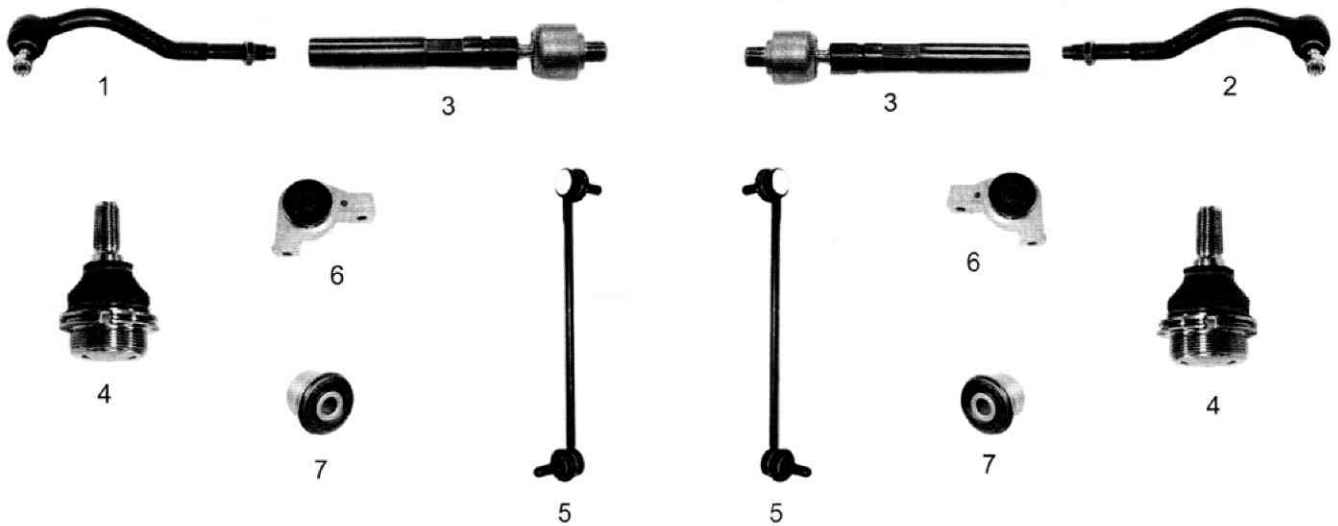

11/2004 |-->

9		Silent-block brazo suspensión Silent-block arm support Silentbloc du bras de suspension Sino-bloco do braço da suspensão		<b>28898</b>	3523 91	30606 30607
10		Silent-block brazo suspensión Silent-block arm support Silentbloc du bras de suspension Sino-bloco do braço da suspensão		<b>28899</b>	3523 92	30606 30607

**RÓTULAS, BRAZOS DE SUSPENSIÓN Y BIELETAS**
**ROTULES, BRAS DE SUSPENSION ET BIELLETES**
**TIE ROD ENDS, SUSPENSION ARMS AND CONNECTING RODS**

03/2001 |--&gt;



					REF. O.E.
1		Rótula dirección Steering ball joint Rotule de direction Rótula de direção	←	Todos los modelos Excepto 2.0 HDI (DCRHYB) L-235mm Ø15,5mm M16x1,5mm Rosca D	<b>25508</b> <b>01.02586.0</b> 3817.53
2		Rótula dirección Steering ball joint Rotule de direction Rótula de direção	→	Todos los modelos Excepto 2.0 HDI (DCRHYB) L-235mm Ø15,5mm M16x1,5mm Rosca D	<b>25509</b> <b>01.02587.0</b> 3817.54
3		Rótula axial Axial ball joint Rotule axiale Rótula axial	← →	L2-185mm M16x1,5/16x1,5mm	<b>01.02588.0</b> 3812.C8
4		Rótula suspensión inferior Lower suspension ball joint Rotule de suspension inférieure Rótula da suspensão inferior	← → ↓	Todos los modelos Excepto 2.0 HDI (DCRHYB) Ø17,5mm	<b>11592</b> <b>01.50516.0</b> 3640.34
5		Bieleta estabilizadora delantera Front stabiliser rod Biellette de stabilisateur avant Biela estabilizadora dianteira	← →	Todos los modelos Excepto 2.0 HDI (DCRHYB) L-320mm M12mm	<b>22724</b> <b>01.02200.0</b> 5087.43/48
6		Soporte de goma (Silentblock) Rubber mounting Support en caoutchouc Suporte goma (Sino-bloco)	← →	Todos los modelos	<b>28896</b> 3523.95
7		Soporte de goma (Silentblock) Rubber mounting Support en caoutchouc Suporte goma (Sino-bloco)	← →	Todos los modelos	<b>28897</b> 3523.84



## RÓTULAS, BRAZOS DE SUSPENSIÓN Y BIELETAS

ROTULES, BRAS DE SUSPENSION ET BIELLETES

TIE ROD ENDS, SUSPENSION ARMS AND CONNECTING RODS

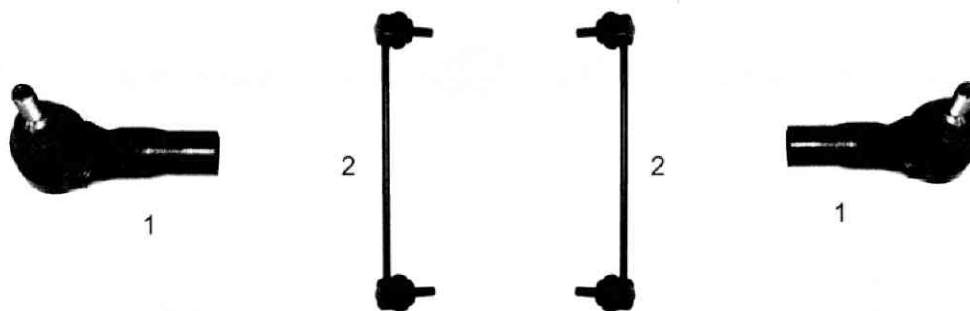
07/2002 |-->



					REF. O.E.
1	 <p>Rótula dirección Steering ball joint Rotule de direction Rótula de direcção</p>	←	→	<p>Todos los modelos Excepto 2.0 16V</p> <p><b>28324</b> <b>04.99827.0</b></p>	4059.12
2	 <p>Bieleta estabilizadora delantera Front stabiliser rod Biellette de stabilisateur avant Biela estabilizadora dianteira</p>	←	→	<p>Todos los modelos Excepto 2.0 16V</p> <p><b>27080</b></p>	5087.51

**RÓTULAS, BRAZOS DE SUSPENSIÓN Y BIELETAS**
*ROTULES, BRAS DE SUSPENSION ET BIELLETES*

## TIE ROD ENDS, SUSPENSION ARMS AND CONNECTING RODS

07/1981 - 02/1994



3-4











3-4



5-7-9



6-8-10



					REF. O.E.
1		Rótula dirección Steering ball joint Rotule de direction Rótula de direcção	← →	L-80mm Ø16,2mm M16x1,5mm Rosca D	<b>11603</b> 4 336 779 <b>04.99758.0</b>
2		Rótula axial Axial ball joint Rotule axiale Rótula axial	← →	L2-287mm M16x1,5/16x1,5mm Rosca D	<b>15377</b> 9750001180 <b>04.99757.0</b>
3		Rótula suspensión inferior Lower suspension ball joint Rotule de suspension inférieure Rótula da suspensão inferior	← → ↓	Ø18,4mm -->  09/1985 Todos los modelos Mod. 2.0E --> Ch N° 289710	<b>14773</b> 3640.18 <b>04.99756.0</b>
4		Rótula suspensión inferior Lower suspension ball joint Rotule de suspension inférieure Rótula da suspensão inferior	← → ↓	Ø19,5mm 10/1985  --> Todos los modelos Mod. 2.0E Ch N° 289711 -->	<b>11591</b> 7567284 <b>04.99755.0</b>
5		Brazo suspensión inferior Lower suspension arm Bras de suspension inférieure Braço da suspensão inferior	← ↓	-->  09/1985	<b>28092</b> 43 918 14 <b>02.05197.0</b>
6		Brazo suspensión inferior Lower suspension arm Bras de suspension inférieure Braço da suspensão inferior	→ ↓	-->  09/1985	<b>28100</b> 43 918 13 <b>02.05196.0</b>
7		Brazo suspensión inferior Lower suspension arm Bras de suspension inférieure Braço da suspensão inferior	← ↓	10/1985 - 1994	<b>22786</b> 75 767 32 <b>02.05217.0</b>
8		Brazo suspensión inferior Lower suspension arm Bras de suspension inférieure Braço da suspensão inferior	→ ↓	10/1985 - 1994	<b>22785</b> 75 767 31 <b>02.05218.0</b>

**RÓTULAS, BRAZOS DE SUSPENSIÓN Y BIELETAS**

*ROTULES, BRAS DE SUSPENSION ET BIELLETES*

TIE ROD ENDS, SUSPENSION ARMS AND CONNECTING RODS

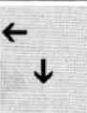
07/1981 - 02/1994

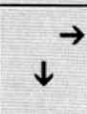



9	 Brazo suspensión inferior Lower suspension arm Bras de suspension inférieur Braço da suspensão inferior		1.8 Tn  <b>28171</b> 02.05341.0	7 567 283
10	 Brazo suspensión inferior Lower suspension arm Bras de suspension inférieur Braço da suspensão inferior		1.8 Tn  <b>28158</b> 02.05340.0	7 567 282

**RÓTULAS, BRAZOS DE SUSPENSIÓN Y BIELETAS**
**ROTULES, BRAS DE SUSPENSION ET BIELLETES**
**TIE ROD ENDS, SUSPENSION ARMS AND CONNECTING RODS**

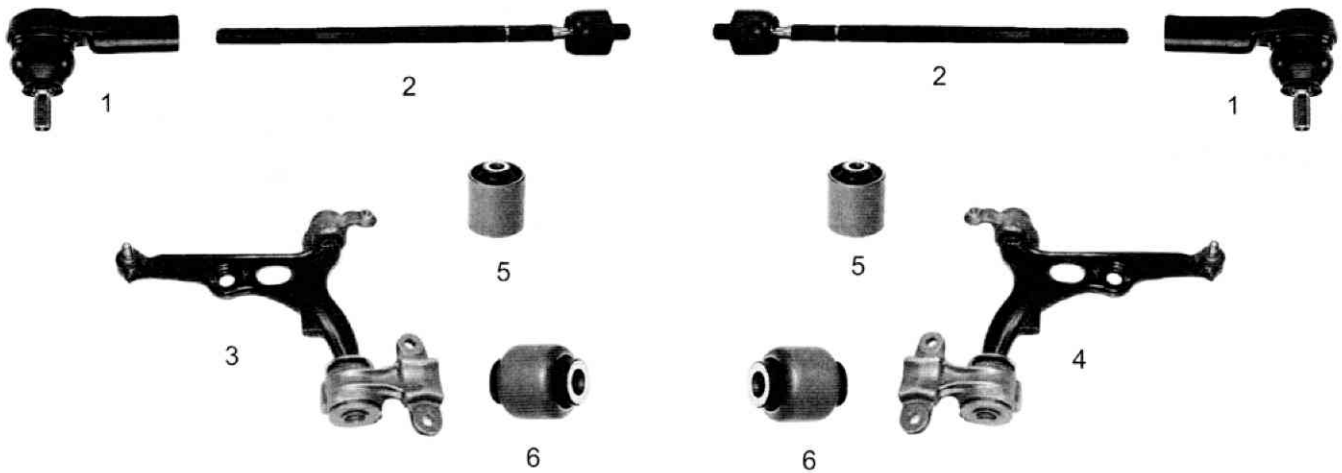
06/1994 - 07/2002

22/U6

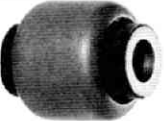

					REF. O.E.
1		Rótula dirección Steering ball joint Rotule de direction Rótula de direcção	← →	Todos los modelos L-74mm Ø14,4mm M14x1,5mm Rosca D	<b>19251</b> 4059.09 <b>04.03655.1</b>
2		Rótula axial Axial ball joint Rotule axiale Rótula axial	← →	L2-350mm M14x1,5/14x1,5mm	<b>27702</b> 3812.A4 <b>04.03656.1</b>
3		Brazo suspensión inferior Lower suspension arm Bras de suspension inférieur Braço da suspensão inferior	← ↓	Todos los modelos 06/1994 - 07/2002	<b>27065</b> 3520.G3 <b>02.05245.0</b>
4		Brazo suspensión inferior Lower suspension arm Bras de suspension inférieur Braço da suspensão inferior	→ ↓	Todos los modelos 06/1994 - 07/2002	<b>27066</b> 3521.83 <b>02.05244.0</b>
5		Soporte de goma (Silentblock) Rubber mounting Support en caoutchouc Suporte goma (Sino-bloco)	← →	Todos los modelos	<b>26578</b> 5152.61
6		Soporte de goma (Silentblock) Rubber mounting Support en caoutchouc Suporte goma (Sino-bloco)	← →	Todos los modelos Excepto 1.9 10/95-12/98	<b>26592</b> 14 60 649 080

## RÓTULAS, BRAZOS DE SUSPENSIÓN Y BIELETAS







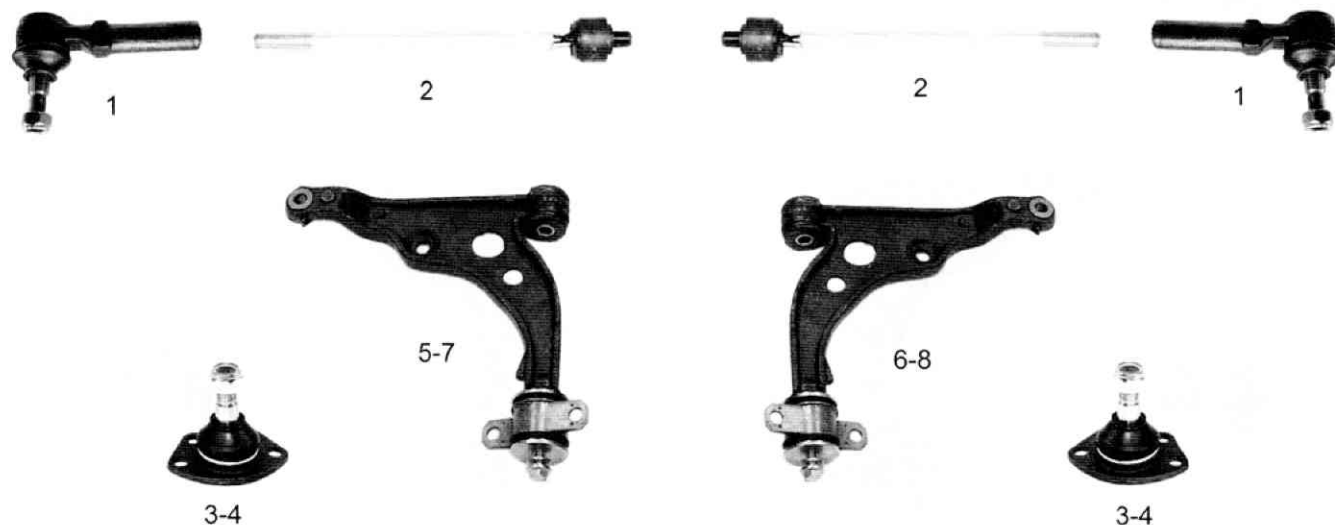

ROTULES, BRAS DE SUSPENSION ET BIELLETES

TIE ROD ENDS, SUSPENSION ARMS AND CONNECTING RODS

230P/230L

02/1994 - 04/2002



					REF. O.E.	
1		Rótula dirección Steering ball joint Rotule de direction Rótula de direcção	← → ↓	Todos los modelos M16x1,5mm	<b>24534</b> 04.03793.1	130 671 60 80
2		Rótula axial Axial ball joint Rotule axiale Rótula axial	← → ↓	Todos los modelos L2-317mm M16x1,5/16x1,5mm	<b>25108</b> 04.03794.1	9945836
3		Rótula suspensión inferior Lower suspension ball joint Rotule de suspension inférieure Rótula da suspensão inferior	← → ↓	Ø19mm 1.0Tn - 1.4Tn Todos los modelos Excepto 2.8 Tdi 01/1998  -->	<b>24538</b> 04.99759.0	130 236 80 80
4		Rótula suspensión inferior Lower suspension ball joint Rotule de suspension inférieure Rótula da suspensão inferior	← → ↓	Ø22mm 1.8Tn Todos los modelos Excepto 2.8 Tdi 01/1998  -->	<b>24539</b> 04.99760.0	130 047 30 80
5		Brazo suspensión inferior Lower suspension arm Bras de suspension inférieur Braço da suspensão inferior	← → ↓	1.000 - 1.400 Kg Para REF: 24538	<b>28153</b> 02.05265.0	130 860 00 80
6		Brazo suspensión inferior Lower suspension arm Bras de suspension inférieur Braço da suspensão inferior	← → ↓	1.000 - 1.400 Kg Para REF: 24538	<b>28152</b> 02.05264.0	130 860 10 80
7		Brazo suspensión inferior Lower suspension arm Bras de suspension inférieur Braço da suspensão inferior	← → ↓	1.800 Kg  --> Para REF: 24539	<b>28155</b> 02.05267.0	1317238080
8		Brazo suspensión inferior Lower suspension arm Bras de suspension inférieur Braço da suspensão inferior	← → ↓	1.800 Kg  --> Para REF: 24539	<b>28154</b> 02.05266.0	1317239080

**RÓTULAS, BRAZOS DE SUSPENSIÓN Y BIELETAS**
**ROTULES, BRAS DE SUSPENSION ET BIELLETES**
**TIE ROD ENDS, SUSPENSION ARMS AND CONNECTING RODS**

04/2002 |--&gt;

244/Z\_

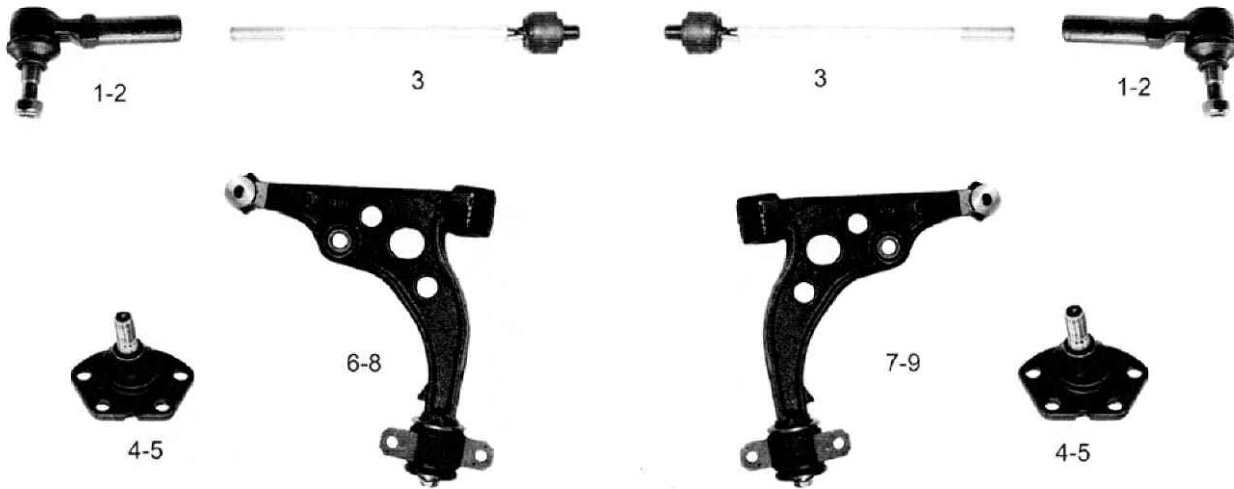

					REF. O.E.
1		Rótula dirección Steering ball joint Rotule de direction Rótula de direcção	← → 04/2002 - 12/2002	<b>24534</b> <b>04.03793.1</b>	4018.A3
2		Rótula dirección Steering ball joint Rotule de direction Rótula de direcção	← → 12/2002  -->	<b>28499</b> <b>04.99829.0</b>	4018.E0
3		Rótula axial Axial ball joint Rotule axiale Rótula axial	← → L2-317mm M16x1,5/16x1,5mm	<b>25108</b> <b>04.03794.1</b>	4018 A4/400624
4		Rótula suspensión inferior Lower suspension ball joint Rotule de suspension inférieure Rótula da suspensão inferior	← → ↓ 1.100 y 1.500 kg Ø16mm	<b>26667</b>	3640 55
5		Rótula suspensión inferior Lower suspension ball joint Rotule de suspension inférieure Rótula da suspensão inferior	← → ↓ 1.800 Kg Ø18,9mm	<b>26668</b>	3640 54
6		Brazo suspensión inferior Lower suspension arm Bras de suspension inférieur Braço da suspensão inferior	← ↓ Ø19 1.100 y 1.500 kg Ch N° -->  16194399 Para REF: 24538 Ch N° 16194400  --> sin restricción	<b>29417</b>	3520 L0/N3
7		Brazo suspensión inferior Lower suspension arm Bras de suspension inférieur Braço da suspensão inferior	→ ↓ Ø19 1.100 y 1.500 kg Ch N° -->  16194399 Para REF: 24538 Ch N° 16194400  --> sin restricción	<b>29418</b>	3521 H2/J3
8		Brazo suspensión inferior Lower suspension arm Bras de suspension inférieur Braço da suspensão inferior	← ↓ Ø22 1.800 kg Ch N° -->  16194399 Para REF:24539 Ch N° 16194400  --> sin restricción	<b>29419</b>	3520 L1/N4
9		Brazo suspensión inferior Lower suspension arm Bras de suspension inférieur Braço da suspensão inferior	→ ↓ Ø22 1.800 kg Ch N° -->  16194399 Para REF:24539 Ch N° 16194400  --> sin restricción	<b>29420</b>	3521 H3/J4



## RÓTULAS, BRAZOS DE SUSPENSIÓN Y BIELETAS









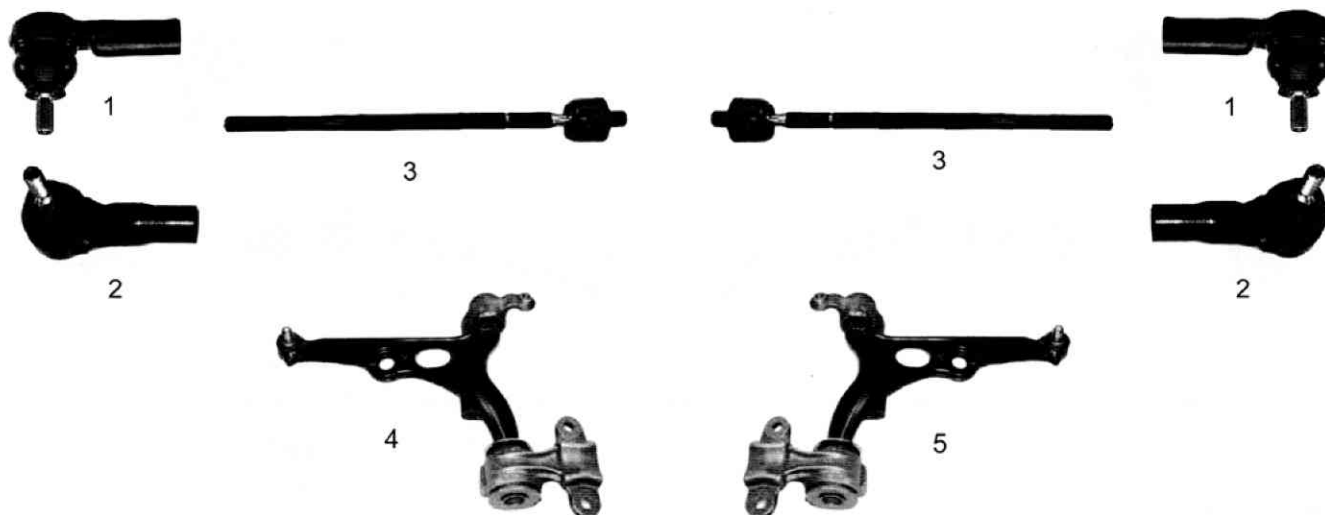





ROTULES, BRAS DE SUSPENSION ET BIELLETES

TIE ROD ENDS, SUSPENSION ARMS AND CONNECTING RODS

U6U

06/1994 |-->











					REF. O.E.
1	 <p>Rótula dirección Steering ball joint Rotule de direction Rótula de direcção</p>	 	<p>Orga N° --&gt;  09792 M14x1,5mm Ø14,4</p>	<p><b>19251</b> <b>04.03655.1</b></p>	4059.09
2	 <p>Rótula dirección Steering ball joint Rotule de direction Rótula de direcção</p>	 	<p>Orga N° 09793  --&gt; M14x1,5mm Ø15,45</p>	<p><b>28324</b> <b>04.99827.0</b></p>	4059.12
3	 <p>Rótula axial Axial ball joint Rotule axiale Rótula axial</p>	 		<p><b>27702</b> <b>04.03656.1</b></p>	3812.A4
4	 <p>Brazo suspensión inferior Lower suspension arm Bras de suspension inférieur Braço da suspensão inferior</p>	 	<p>Todos los modelos 06/1994 - 07/2002</p>	<p><b>27065</b> <b>02.05245.0</b></p>	3520.G3
5	 <p>Brazo suspensión inferior Lower suspension arm Bras de suspension inférieur Braço da suspensão inferior</p>	 	<p>Todos los modelos 06/1994 - 07/2002</p>	<p><b>27066</b> <b>02.05244.0</b></p>	3521.83

**RÓTULAS, BRAZOS DE SUSPENSIÓN Y BIELETAS**
*ROTULES, BRAS DE SUSPENSION ET BIELLETES*

## TIE ROD ENDS, SUSPENSION ARMS AND CONNECTING RODS

11/1976 - 04/1985



					REF. O.E.
1	 Rótula dirección Steering ball joint Rotule de direction Rótula de direcção	 ← →	L-90mm Ø14,6mm M14x1,5mm Rosca D	 <b>12070</b> 01.00924.1	95 493 208 19338
2	 Rótula suspensión inferior Lower suspension ball joint Rotule de suspension inférieure Rótula da suspensão inferior	 ← → ↓	Ø14mm	<b>15613</b> 01.00053.0	91 504 248
3	 Brazo suspensión inferior Lower suspension arm Bras de suspension inférieur Braço da suspensão inferior	 ← ↓		<b>17408</b> 01.00061.0	91 504 354
4	 Brazo suspensión inferior Lower suspension arm Bras de suspension inférieur Braço da suspensão inferior	 → ↓		<b>17409</b> 01.00060.0	91 504 355

RÓTULAS, BRAZOS DE SUSPENSIÓN Y BIELETAS





ROTULES, BRAS DE SUSPENSION ET BIELLETES

TIE ROD ENDS, SUSPENSION ARMS AND CONNECTING RODS

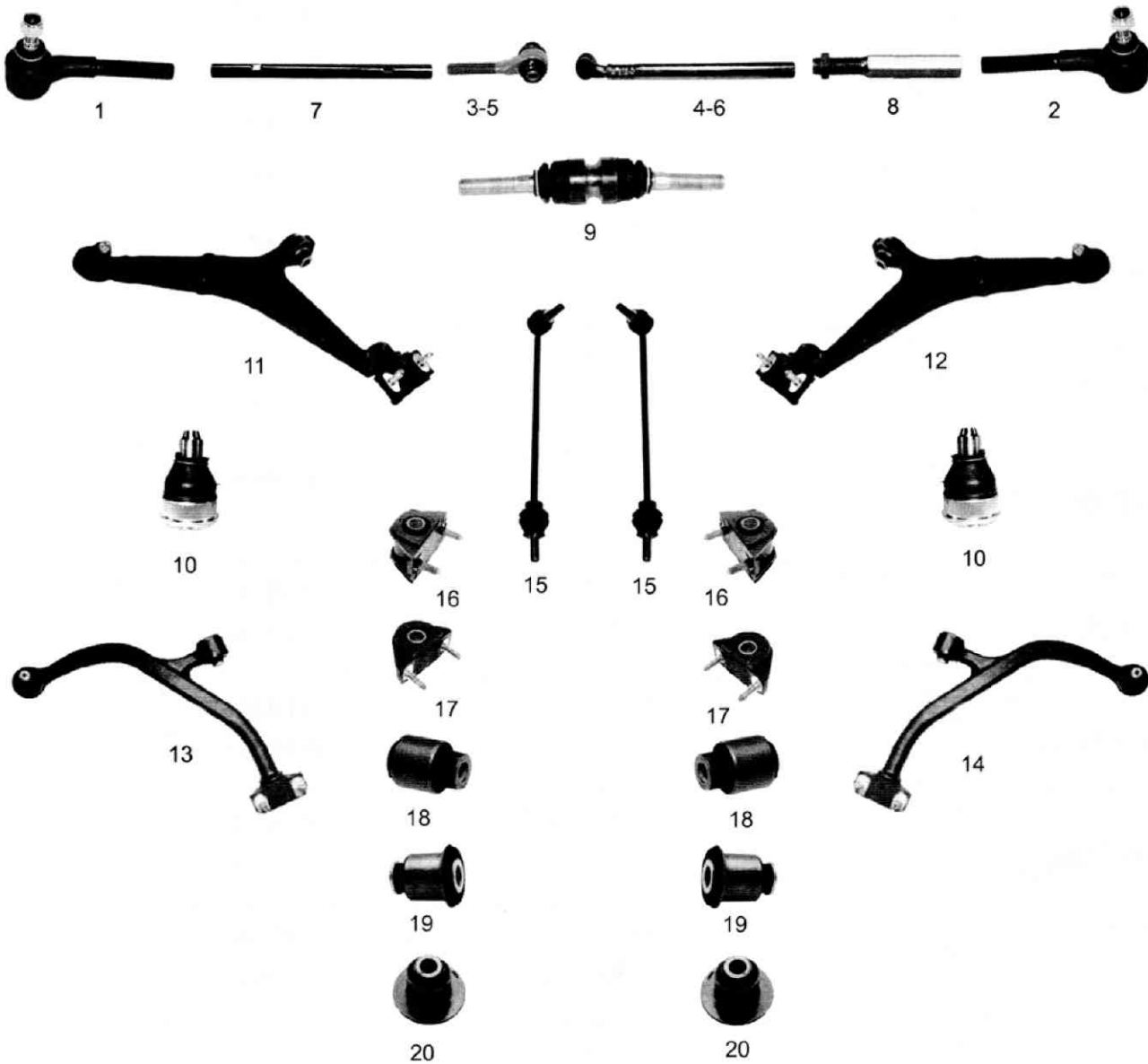
S0/S1

05/1996 |-->

















					REF. O.E.
1	 Rótula dirección Steering ball joint Rotule de direction Rótula de direção	←	Todos los modelos Excepto 1.4,1.6i 16V,1.6 VTS 72kW L-114mm Ø14,6mm M14x1,5mm Rosca D	<b>14799</b> <b>01.03124.1</b>	3817.41
2	 Rótula dirección Steering ball joint Rotule de direction Rótula de direção	→	Todos los modelos Excepto 1.4,1.6i 16V,1.6 VTS 72kW L-114mm Ø14,6mm M14x1,5mm Rosca D	<b>14800</b> <b>01.03125.1</b>	3817.42
3	 Tubo unión Connection pipe Tube de jonction Tubo de união	←	Dir. Manual	<b>27983</b> <b>01.02301.0</b>	3817.32
4	 Tubo unión Connection pipe Tube de jonction Tubo de união	→	L-333mm M16x1,5mm Rosca D	<b>27982</b> <b>01.02300.0</b>	3817.35

**RÓTULAS, BRAZOS DE SUSPENSIÓN Y BIELETAS**
**ROTULES, BRAS DE SUSPENSION ET BIELLETES**
**TIE ROD ENDS, SUSPENSION ARMS AND CONNECTING RODS**

05/1996 |--&gt;

S0/S1

5		Tirante dirección Steering brace Tirant de direction Tirante direcção	←	Dir. Asistida Todos los modelos Excepto 1.4,1.6i 16V	<b>22327</b> 01.02207.0	3817.33
6		Tirante dirección Steering brace Tirant de direction Tirante de direcção	→	Dir. Asistida	<b>27981</b> 01.02208.0	3817.36
7		Tirante dirección Steering brace Tirant de direction Tirante direcção	←	L-380mm	<b>27979</b> 01.02209.0	3812.A0/95609129
8		Tirante dirección Steering brace Tirant de direction Tirante de direcção	→		<b>01.02641.0</b>	3817.34
9		Rótula axial central Axial ball joint centre Rotule axiale centrale Rótula axial central	✳	Todos los modelos Excepto 1.4,1.6i 16V,1.6 VTS 72kW	<b>25256</b>	3817 47
10		Rótula suspensión inferior Lower suspension ball joint Rotule de suspension inférieure Rótula da suspensão inferior	← → ↓	Ø16mm Todos los modelos 08/1991  -->	<b>15334</b> 01.50501.0	3640.36/96 093 233 17434 17433 26736 ...
11		Brazo suspensión inferior Lower suspension arm Bras de suspension inférieure Braço da suspensão inferior	← ↓	Ø16mm Todos los modelos 08/1991  -->	<b>17433</b> 02.05119.0	3520.78 15334 17452 24512
12		Brazo suspensión inferior Lower suspension arm Bras de suspension inférieure Braço da suspensão inferior	→ ↓	Ø16mm Todos los modelos 08/1991  -->	<b>17434</b> 02.05118.0	3520.79 15334 17452 24512
13		Brazo suspensión inferior Lower suspension arm Bras de suspension inférieure Braço da suspensão inferior	← ↓	(GTI) Mod. 1.6 cód.motor: TV5JP/TV5JP4	<b>26736</b> 02.05214.0	3520.92 15334 24516 17451
14		Brazo suspensión inferior Lower suspension arm Bras de suspension inférieure Braço da suspensão inferior	→ ↓	(GTI) Mod. 1.6 cód.motor: TV5JP/TV5JP4	<b>26735</b> 02.05213.0	3520.93 15334 24515 17451
15		Bieleta estabilizadora delantera Front stabiliser rod Biellette de stabilisateur avant Biela estabilizadora dianteira	← →	L-323mm M12x1,75mm Motor TWJSP Todos los modelos	<b>17464</b> 01.03518.1	5087.40
16		Soporte de goma (Silentblock) Rubber mounting Support en caoutchouc Suporte goma (Sino-bloco)	← → ↓	Mod. 1.0, 1.1X,SX, 1.5D	<b>17452</b>	3523.51 17433 17434
17		Silent-block brazo suspensión Silent-block arm support Silentbloc du bras de suspension Sino-bloco do braço da suspensão	← → ↓	Mod. 1.6 VTL,VTR,VTS 87W	<b>24515</b>	96 148 480 26736 26735
18		Silent-block brazo suspensión Silent-block arm support Silentbloc du bras de suspension Sino-bloco do braço da suspensão	← → ↓	Mod. 1.0, 1.1X,SX, 1.5D	<b>24512</b>	3523.50 17433 17434

**RÓTULAS, BRAZOS DE SUSPENSIÓN Y BIELETAS**

*ROTULES, BRAS DE SUSPENSION ET BIELLETES*









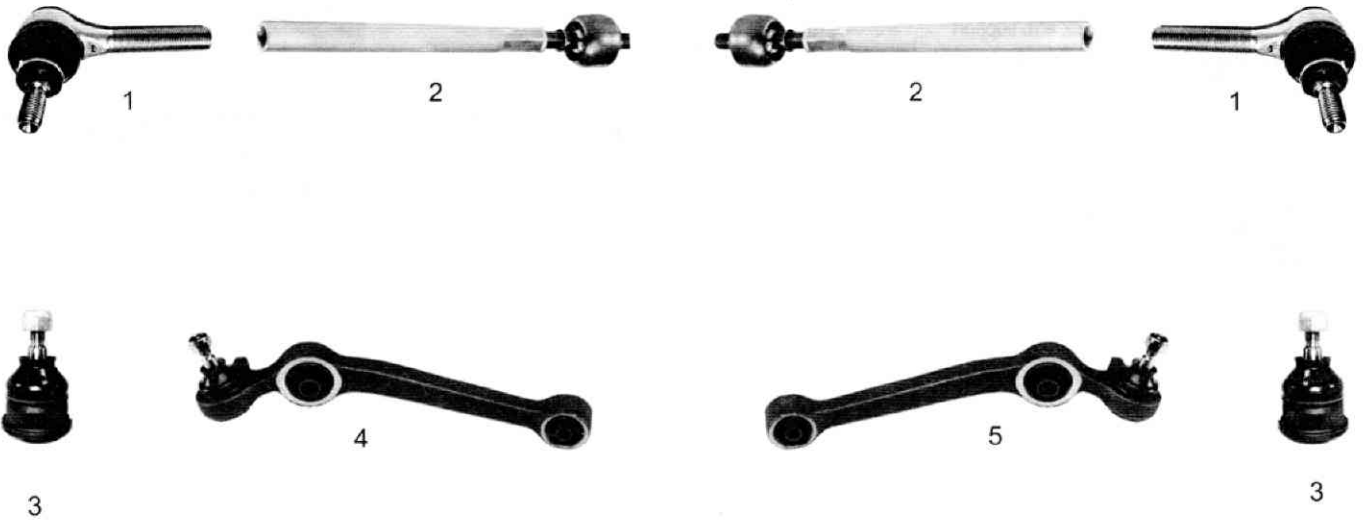









TIE ROD ENDS, SUSPENSION ARMS AND CONNECTING RODS

S0/S1

05/1996 |-->

19		Silent-block brazo suspensión Silent-block arm support Silentbloc du bras de suspension Sino-bloco do braço da suspensão		Mod. 1.0, 1.1X, SX, 1.4 VTS Mod. 1.6 VTL, VTR, VTS 87W	<b>17451</b>	3523.52	26736 26735
						<b>REF. O.E.</b>	
20		Soporte de cuerpo de eje Axle body mounting Support de corps de l'essieu Suporte goma corpo do eixo		Mod. 1.0 X, 1.4 VTS, 1.5 D Mod. 1.6 VTL, VTR, VTS 87W	<b>22509</b>	5131 63	

**RÓTULAS, BRAZOS DE SUSPENSIÓN Y BIELETAS**
**ROTULES, BRAS DE SUSPENSION ET BIELLETES**
**TIE ROD ENDS, SUSPENSION ARMS AND CONNECTING RODS**
**09/1978 - 1982**

					REF. O.E.
1	 Rótula dirección Steering ball joint Rotule de direction Rótula de direcção	  ← →	Todos los modelos L-90mm Ø14,6mm M14x1,5mm Rosca D		<b>12070</b> 3817.10/50 <b>01.00924.1</b>
2	 Rótula axial Axial ball joint Rotule axiale Rótula axial	  ← →	L2-263mm M12x1/M14x1,5mm		<b>12282</b> - <b>01.00931.1</b>
3	 Rótula suspensión inferior Lower suspension ball joint Rotule de suspension inférieure Rótula da suspensão inferior	  ← → 	Mod. 0.6/1.0/1.1/1.2/1.4/1.6 Ø14mm		<b>15613</b> 91 504 248 <b>01.00053.0</b>
4	 Brazo suspensión inferior Lower suspension arm Bras de suspension inférieur Braço da suspensão inferior	  ← → 	-->  06/1980		<b>17408</b> 91 504 354 <b>01.00061.0</b>
5	 Brazo suspensión inferior Lower suspension arm Bras de suspension inférieur Braço da suspensão inferior	  ← → 	-->  06/1980		<b>17409</b> 91 504 355 <b>01.00060.0</b>





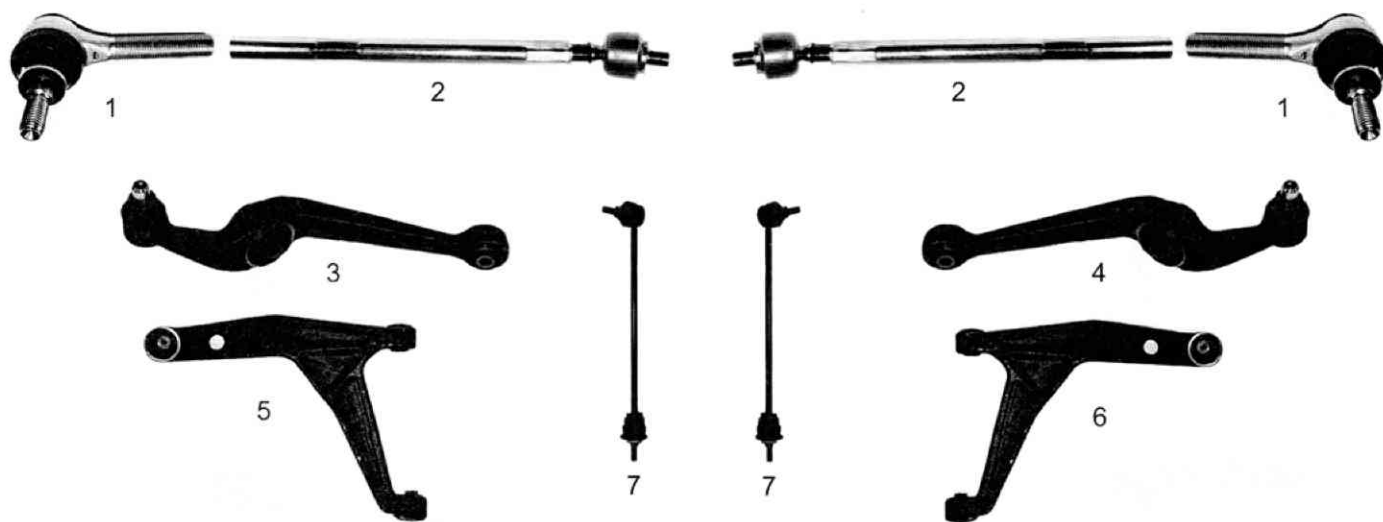

## RÓTULAS, BRAZOS DE SUSPENSIÓN Y BIELETAS

ROTULES, BRAS DE SUSPENSION ET BIELLETES

TIE ROD ENDS, SUSPENSION ARMS AND CONNECTING RODS

1982 - 03/1991



					REF. O.E.
1	 <p>Rótula dirección Steering ball joint Rotule de direction Rótula de direcção</p>	<p>← →</p>	Todos los modelos	<p><b>12070</b> 01.00924.1</p>	3817.10
2	 <p>Rótula axial Axial ball joint Rotule axiale Rótula axial</p>	<p>← →</p>	Todos los modelos	<p><b>11658</b> 01.03041.1</p>	-
3	 <p>Brazo suspensión inferior Lower suspension arm Bras de suspension inférieur Braço da suspensão inferior</p>	<p>← ↓</p>	Todos los modelos	<p><b>12064</b> 01.03043.0</p>	91 516 336 19247
4	 <p>Brazo suspensión inferior Lower suspension arm Bras de suspension inférieur Braço da suspensão inferior</p>	<p>→ ↓</p>	Todos los modelos	<p><b>12065</b> 01.03042.0</p>	91 516 337 19247
5	 <p>Brazo suspensión inferior Lower suspension arm Bras de suspension inférieur Braço da suspensão inferior</p>	<p>← ↓</p>	Mod. GTI	<p><b>28077</b> 02.05099.0</p>	91 519 408
6	 <p>Brazo suspensión inferior Lower suspension arm Bras de suspension inférieur Braço da suspensão inferior</p>	<p>→ ↓</p>	Mod. GTI	<p><b>28076</b> 02.05098.0</p>	91 519 409
7	 <p>Bieleta estabilizadora delantera Front stabiliser rod Biellette de stabilisateur avant Biela estabilizadora dianteira</p>	<p>← →</p>	Mod. 1.6 L-312mm	<p><b>11588</b> 01.03498.1</p>	5087.32

**RÓTULAS, BRAZOS DE SUSPENSIÓN Y BIELETAS**
**ROTULES, BRAS DE SUSPENSION ET BIELLETES**
**TIE ROD ENDS, SUSPENSION ARMS AND CONNECTING RODS**

03/1993 |--&gt;

X1/X2

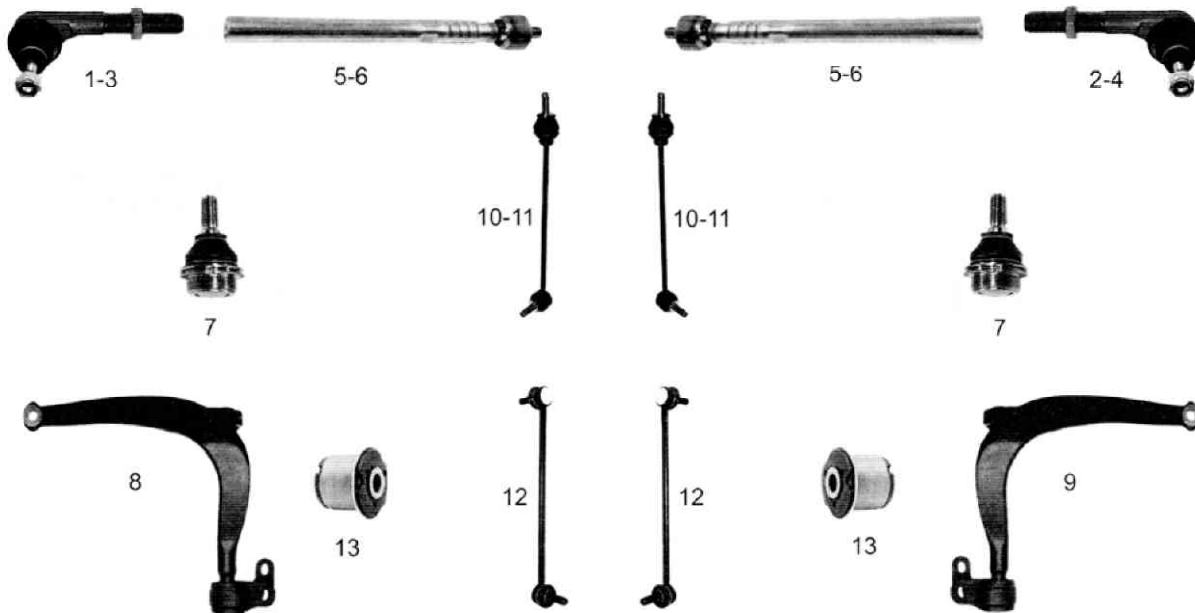

						REF. O.E.
1		Rótula dirección Steering ball joint Rotule de direction Rótula de direcção	←	Dir. Manual Todos los modelos	<b>14799</b>	3817.41 01.03124.1
2		Rótula dirección Steering ball joint Rotule de direction Rótula de direcção	→	Dir. Manual Todos los modelos	<b>14800</b>	3817.42 01.03125.1
3		Rótula dirección Steering ball joint Rotule de direction Rótula de direcção	←	Mod. 2.0/2.1 Dir. Asistida 06/1995 - 01/1998	<b>26750</b>	3817.43/37 01.02204.0
4		Rótula dirección Steering ball joint Rotule de direction Rótula de direcção	→	Mod. 2.0/2.1 Dir. Asistida 06/1995 - 01/1998	<b>26751</b>	3817.44/38 01.02205.0
5		Rótula axial Axial ball joint Rotule axiale Rótula axial	← →	Dir. Manual	<b>19304</b>	96 136 394 01.00101.1
6		Rótula axial Axial ball joint Rotule axiale Rótula axial	← →	Dir. Asistida	<b>25488</b>	3812.A6 01.02206.0
7		Rótula suspensión inferior Lower suspension ball joint Rotule de suspension inférieure Rótula da suspensão inferior	← → ↓	Todos los modelos	<b>11592</b>	3640.34 01.50516.0
8		Brazo suspensión inferior Lower suspension arm Bras de suspension inférieur Braço da suspensão inferior	← ↓	Todos los modelos	<b>26730</b>	3520.C1/C2 02.05125.0











## RÓTULAS, BRAZOS DE SUSPENSIÓN Y BIELETAS

ROTULES, BRAS DE SUSPENSION ET BIELLETES

TIE ROD ENDS, SUSPENSION ARMS AND CONNECTING RODS

X1/X2

03/1993 |-->





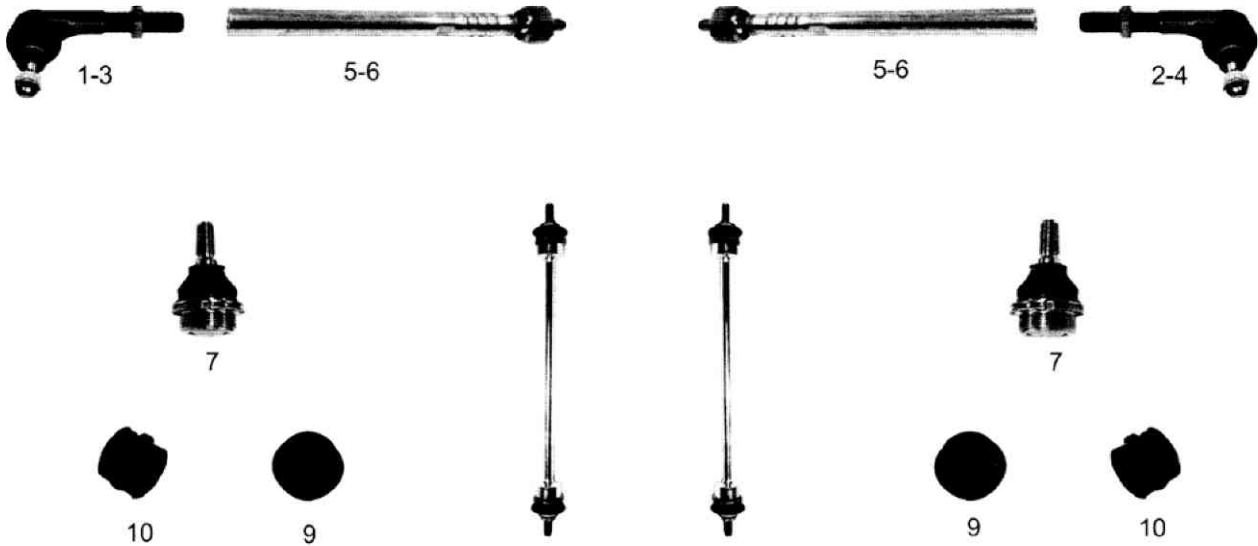

9		Brazo suspensión inferior Lower suspension arm Bras de suspension inférieur Braço da suspensão inferior	→ ↓	Todos los modelos	<b>26729</b> <b>02.05124.0</b>	3521.58/82/81
10		Bieleta estabilizadora delantera Front stabiliser rod Biellette de stabilisateur avant Biela estabilizadora dianteira	← →	Susp. normal -->  01/1996 Todos los modelos -->  Ch N° O 6614	<b>11601</b> <b>01.02201.0</b>	96 145 457
11		Bieleta estabilizadora delantera Front stabiliser rod Biellette de stabilisateur avant Biela estabilizadora dianteira	← →	Susp. normal 8151  --> 01/1996  --> Todos los modelos Ch N° O 6615  -->	<b>17464</b> <b>01.03518.1</b>	5087.40
12		Bieleta estabilizadora delantera Front stabiliser rod Biellette de stabilisateur avant Biela estabilizadora dianteira	← →		<b>22724</b> <b>01.02200.0</b>	5087.48
						<b>REF. O.E.</b>
13		Soporte de goma (Silentblock) Rubber mounting Support en caoutchouc Suporte goma (Sino-bloco)	← → ↑		<b>22513</b>	-

**RÓTULAS, BRAZOS DE SUSPENSIÓN Y BIELETAS**
**ROTULES, BRAS DE SUSPENSION ET BIELLETES**
**TIE ROD ENDS, SUSPENSION ARMS AND CONNECTING RODS**

05/1989 - 10/2000

Y3/Y4

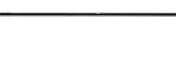

					REF. O.E.
1	 Rótula dirección Steering ball joint Rotule de direction Rótula de direcção	←	Todos los modelos L-114mm Ø14,6mm M14x1,5mm Rosca D	<b>14799</b> <b>01.03124.1</b>	3817.14/30/41
2	 Rótula dirección Steering ball joint Rotule de direction Rótula de direcção	→	Todos los modelos L-114mm Ø14,6mm M14x1,5mm Rosca D	<b>14800</b> <b>01.03125.1</b>	3817.16/31/42
3	 Rótula dirección Steering ball joint Rotule de direction Rótula de direcção	←	Dir. Asistida L-110mm Ø16mm M16x1,5mm	<b>26750</b> <b>01.02204.0</b>	3817.43
4	 Rótula dirección Steering ball joint Rotule de direction Rótula de direcção	→	Dir. Asistida L-110mm Ø16mm M16x1,5mm	<b>26751</b> <b>01.02205.0</b>	3817.44
5	 Rótula axial Axial ball joint Rotule axiale Rótula axial	← →	Todos los modelos L2-294mm M12x1/14x1,5mm	<b>14791</b> <b>01.50803.0</b>	3812.99
6	 Rótula axial Axial ball joint Rotule axiale Rótula axial	← →	L2-293mm M12x1/16x1,5mm	<b>25488</b> <b>01.02206.0</b>	3812.A6
7	 Rótula suspensión inferior Lower suspension ball joint Rotule de suspension inférieure Rótula da suspensão inferior	← → ↓	Todos los modelos	<b>11592</b> <b>01.50516.0</b>	3640.28/34
8	 Bieleta estabilizadora delantera Front stabiliser rod Biellette de stabilisateur avant Biela estabilizadora dianteira	← →	Todos los modelos L-345mm Ø10mm	<b>11580</b> <b>01.50514.0</b>	5087.41/49

**RÓTULAS, BRAZOS DE SUSPENSIÓN Y BIELETAS**

*ROTULES, BRAS DE SUSPENSION ET BIELLETES*

TIE ROD ENDS, SUSPENSION ARMS AND CONNECTING RODS

Y3/Y4

05/1989 - 10/2000





9		Silent-block brazo suspensión Silent-block arm support Silentbloc du bras de suspension Sino-bloco do braço da suspensão		Todos los modelos	<b>29376</b>	3523 43
10		Silent-block barra estabilizadora Rubber mounting Support en caoutchouc Suporte goma (Sino-bloco) estabilizador		Todos los modelos Ø23mm	<b>26575</b>	95 638 690

**RÓTULAS, BRAZOS DE SUSPENSIÓN Y BIELETAS**
**ROTULES, BRAS DE SUSPENSION ET BIELLETES**
**TIE ROD ENDS, SUSPENSION ARMS AND CONNECTING RODS**

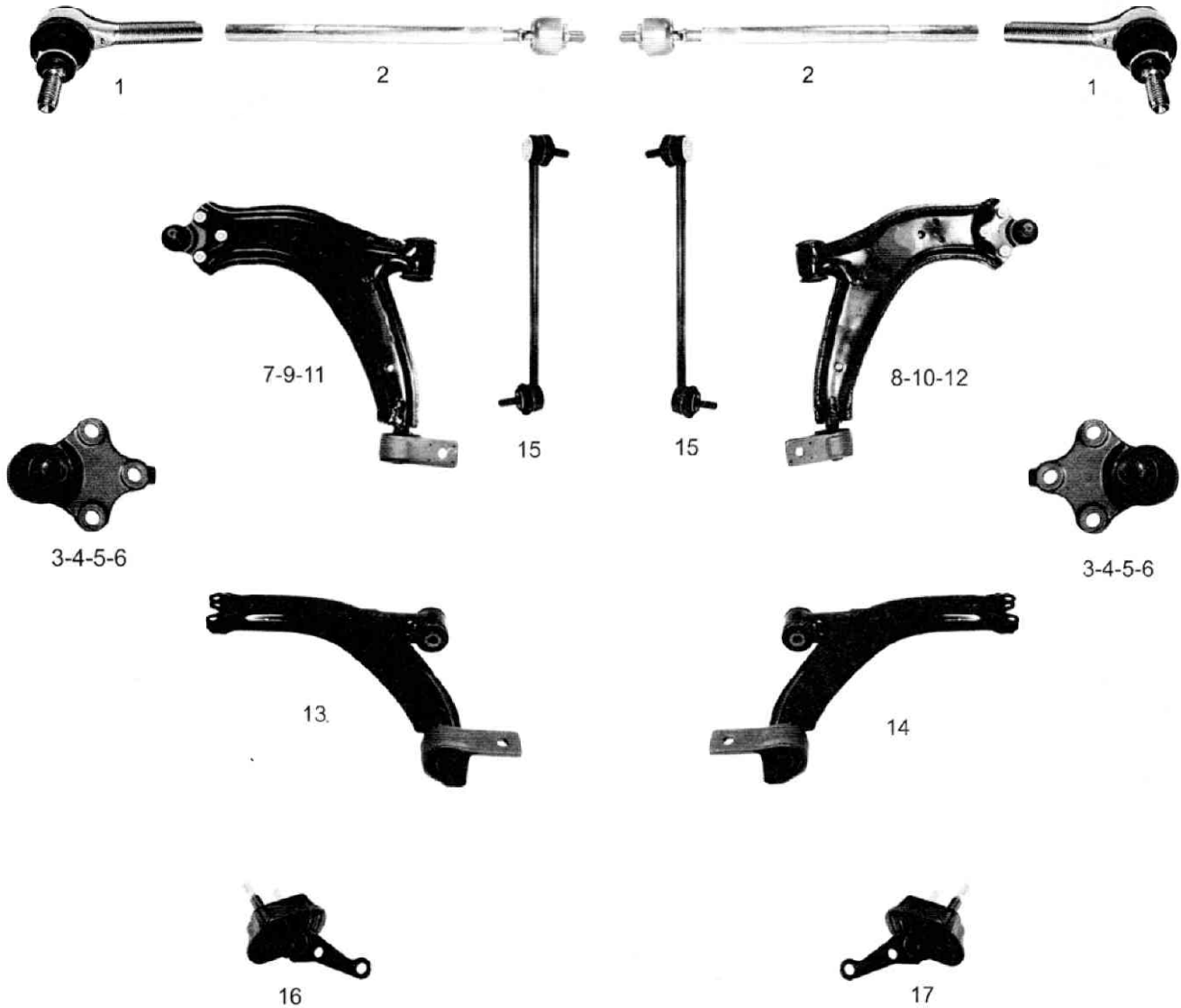
04/1997 |--&gt;

N1/N2/N0



					REF. O.E.
1	 Rótula dirección Steering ball joint Rotule de direction Rótula de direcção	← → Todos los modelos	ⓘ	⚠	<b>12070</b> 3817.50 <b>01.00924.1</b>
2	 Rótula axial Axial ball joint Rotule axiale Rótula axial	← → Todos los modelos	ⓘ	⚠	<b>14792</b> 3812.00 <b>01.50504.0</b>
3	 Rótula suspensión inferior Lower suspension ball joint Rotule de suspension inférieure Rótula da suspensão inferior	← → Dir. manual y Dir. Asistida Ø16mm ↓ Todos los modelos Excepto 1.4Hdi, 1.6 16V, 2.0 Hdi 109	ⓘ	⚠	<b>14767</b> 3640.39/42/43 <b>01.50500.0</b> 17436 17435
4	 Rótula suspensión inferior Lower suspension ball joint Rotule de suspension inférieure Rótula da suspensão inferior	← → Ø18mm ↓ Todos los modelos Excepto 1.4Hdi	ⓘ	⚠	<b>25534</b> 3640.51 <b>01.02202.0</b> 28125 28126













## RÓTULAS, BRAZOS DE SUSPENSIÓN Y BIELETAS

## ROTULES, BRAS DE SUSPENSION ET BIELLETES

## TIE ROD ENDS, SUSPENSION ARMS AND CONNECTING RODS

N1/N2/N0

04/1997 |--&gt;





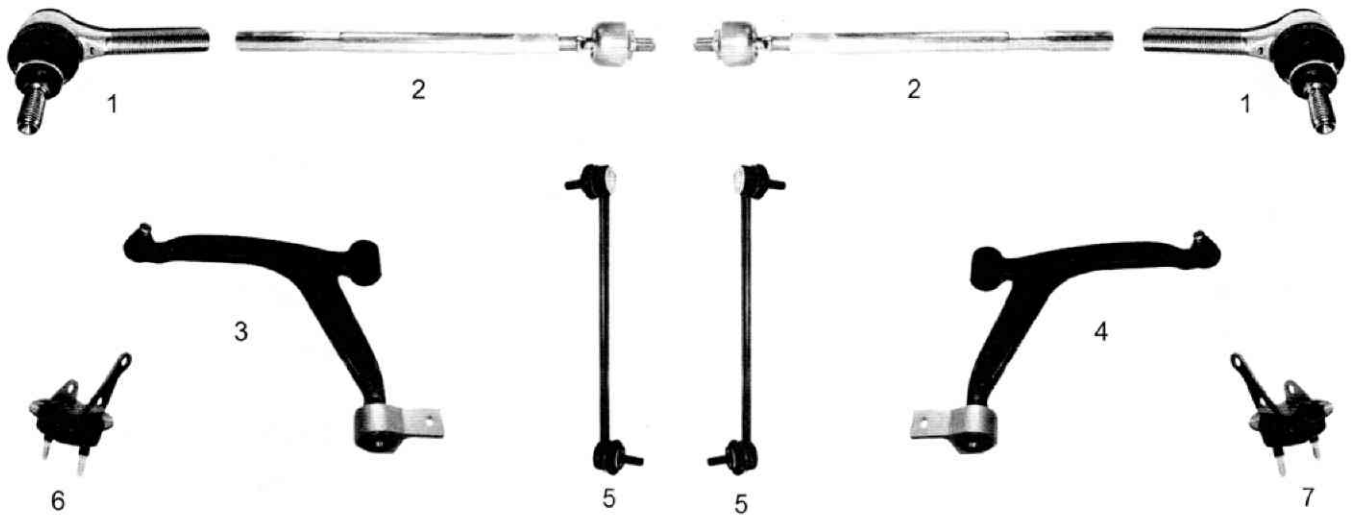

5		Rótula suspensión inferior Lower suspension ball joint Rotule de suspension inférieure Rótula da suspensão inferior	← → ↓	Ø18mm Todos los modelos Excepto 1.4Hdi	<b>26047</b>	3640 50 02.05628.0 02.05629.0
6		Rótula suspensión inferior Lower suspension ball joint Rotule de suspension inférieure Rótula da suspensão inferior	← → ↓	Motor 1.4 i (TU3JP) chasis 08512  --> Dir. Asistida	<b>28971</b>	3640 52
7		Brazo suspensión inferior Lower suspension arm Bras de suspension inférieure Braço da suspensão inferior	← ↓	Dir. manual y Dir. Asistida Todos los modelos Ø16mm	<b>17435</b> <b>02.05121.0</b>	3520.H8/H6/H5 14767 27711
8		Brazo suspensión inferior Lower suspension arm Bras de suspension inférieure Braço da suspensão inferior	↓ →	Dir. manual y Dir. Asistida Todos los modelos Ø16mm	<b>17436</b> <b>02.05120.0</b>	3521.E6 14767 27712
9		Brazo suspensión inferior Lower suspension arm Bras de suspension inférieure Braço da suspensão inferior	← ↓	Ø18mm	<b>28125</b> <b>02.05390.0</b>	- 25534 27711
10		Brazo suspensión inferior Lower suspension arm Bras de suspension inférieure Braço da suspensão inferior	↓ →	Ø18mm	<b>28126</b> <b>02.05391.0</b>	- 25534 27712
11		Brazo suspensión inferior Lower suspension arm Bras de suspension inférieure Braço da suspensão inferior	← ↓		<b>02.05629.0</b>	- 26047
12		Brazo suspensión inferior Lower suspension arm Bras de suspension inférieure Braço da suspensão inferior	↓ →		<b>02.05628.0</b>	- 26047
13		Brazo suspensión inferior (sin rótula) Lower suspension arm (NO ball joint) Bras de suspension inférieure (Sans Rotule) Braço da suspensão inferior (NO rótula)	← ↓		<b>27711</b> <b>02.05568.0</b>	- 17435 28125
14		Brazo suspensión inferior (sin rótula) Lower suspension arm (NO ball joint) Bras de suspension inférieure (Sans Rotule) Braço da suspensão inferior (NO rótula)	↓ →		<b>27712</b> <b>02.05569.0</b>	- 17436 28126
15		Bieleta estabilizadora delantera Front stabiliser rod Biellette de stabilisateur avant Biela estabilizadora dianteira	← →	Todos los modelos L-300mm M10x1,5mm	<b>11589</b> <b>01.02203.0</b>	5087.39/42/46
16		Soporte de goma (Silentblock) Rubber mounting Support en caoutchouc Suporte goma (Sino-bloco)	←	Todos los modelos	<b>19307</b>	5131.69
17		Soporte de goma (Silentblock) Rubber mounting Support en caoutchouc Suporte goma (Sino-bloco)	→	Todos los modelos	<b>19257</b>	5131 70

**RÓTULAS, BRAZOS DE SUSPENSIÓN Y BIELETAS**
**ROTULES, BRAS DE SUSPENSION ET BIELLETES**
**TIE ROD ENDS, SUSPENSION ARMS AND CONNECTING RODS**

12/1999 |--&gt;

N68



					REF. O.E.
1	 Rótula dirección Steering ball joint Rotule de direction Rótula de direcção	← →	Todos los modelos	<b>12070</b>	3817.50 <b>01.00924.1</b>
2	 Rótula axial Axial ball joint Rotule axiale Rótula axial	← →	Todos los modelos	<b>14792</b>	3812.C6 <b>01.50504.0</b>
3	 Brazo suspensión inferior Lower suspension arm Bras de suspension inférieur Braço da suspensão inferior	← ↓	Todos los modelos	<b>26714</b>	3520.J3 <b>02.05541.0</b>
4	 Brazo suspensión inferior Lower suspension arm Bras de suspension inférieur Braço da suspensão inferior	← ↓	Todos los modelos	<b>26715</b>	3521.F3 <b>02.05540.0</b>
5	 Bieleta estabilizadora delantera Front stabiliser rod Bielle de stabilisateur avant Biela estabilizadora dianteira	← →	Todos los modelos	<b>11589</b>	5087.46 <b>01.02203.0</b>
6	 Soporte de goma (Silentblock) Rubber mounting Support en caoutchouc Suporte goma (Sino-bloco)	←	Todos los modelos	<b>19307</b>	5131.69
7	 Soporte de goma (Silentblock) Rubber mounting Support en caoutchouc Suporte goma (Sino-bloco)	→	Todos los modelos	<b>19257</b>	5131 70

**RÓTULAS, BRAZOS DE SUSPENSIÓN Y BIELETAS**









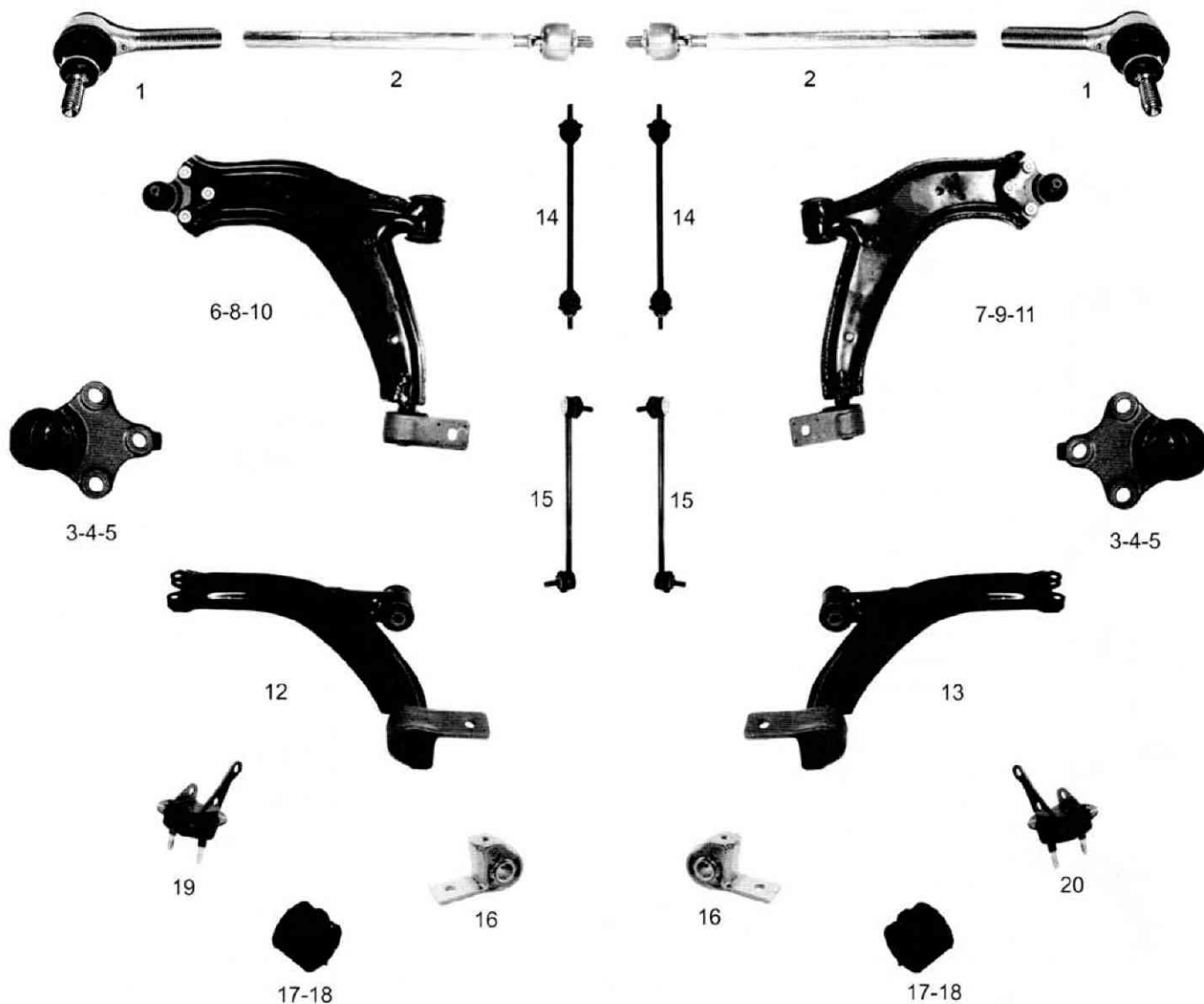





*ROTULES, BRAS DE SUSPENSION ET BIELLETES*

TIE ROD ENDS, SUSPENSION ARMS AND CONNECTING RODS













N2

03/1991 - 10/1997

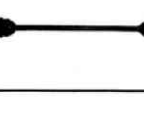

				REF. O.E.
1	 Rótula dirección Steering ball joint Rotule de direction Rótula de direcção	  Todos los modelos	<b>12070</b> <b>01.00924.1</b>	3817.50
2	 Rótula axial Axial ball joint Rotule axiale Rótula axial	  Dir. Manual - Dir. Asistida Todos los modelos	<b>14792</b> <b>01.50504.0</b>	3812.00
3	 Rótula suspensión inferior Lower suspension ball joint Rotule de suspension inférieure Rótula da suspensão inferior	   Dir. Manual y Dir. Asistida	<b>14767</b> <b>01.50500.0</b>	3640.39/42/43 17436 17435
4	 Rótula suspensión inferior Lower suspension ball joint Rotule de suspension inférieure Rótula da suspensão inferior	   Ø18mm	<b>25534</b> <b>01.02202.0</b>	3640.51 28125 28126

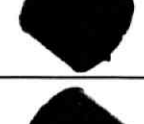
**RÓTULAS, BRAZOS DE SUSPENSIÓN Y BIELETAS**
**ROTULES, BRAS DE SUSPENSION ET BIELLETES**
**TIE ROD ENDS, SUSPENSION ARMS AND CONNECTING RODS**
**03/1991 - 10/1997**
**N2**

5		Rótula suspensión inferior Lower suspension ball joint Rotule de suspension inférieure Rótula da suspensão inferior	← → ↓	Ø18mm	<b>26047</b>	3640 50 02.05628.0 02.05629.0
6		Brazo suspensión inferior Lower suspension arm Bras de suspension inférieure Braço da suspensão inferior	← ↓	Dir. Manual y Dir. Asistida Todos los modelos	<b>17435</b> <b>02.05121.0</b>	3520.H8/H6/H5 14767 27711
7		Brazo suspensión inferior Lower suspension arm Bras de suspension inférieure Braço da suspensão inferior	→ ↓	Dir. Manual y Dir. Asistida Todos los modelos	<b>17436</b> <b>02.05120.0</b>	3521.E8/E6/E5 14767 27712
8		Brazo suspensión inferior Lower suspension arm Bras de suspension inférieure Braço da suspensão inferior	← ↓	Ø18mm	<b>28125</b> <b>02.05390.0</b>	- 25534 27711
9		Brazo suspensión inferior Lower suspension arm Bras de suspension inférieure Braço da suspensão inferior	→ ↓	Ø18mm	<b>28126</b> <b>02.05391.0</b>	- 25534 27712
10		Brazo suspensión inferior Lower suspension arm Bras de suspension inférieure Braço da suspensão inferior	← ↓		<b>02.05629.0</b>	- 26047
11		Brazo suspensión inferior Lower suspension arm Bras de suspension inférieure Braço da suspensão inferior	→ ↓		<b>02.05628.0</b>	- 26047
12		Brazo suspensión inferior (sin rótula) Lower suspension arm (NO ball joint) Bras de suspension inférieure (Sans Rotule) Braço da suspensão inferior (NO rótula)	← ↓		<b>27711</b> <b>02.05568.0</b>	- 17435 28125
13		Brazo suspensión inferior (sin rótula) Lower suspension arm (NO ball joint) Bras de suspension inférieure (Sans Rotule) Braço da suspensão inferior (NO rótula)	→ ↓		<b>27712</b> <b>02.05569.0</b>	- 17436 28126
14		Bieleta estabilizadora delantera Front stabiliser rod Biellette de stabilisateur avant Biela estabilizadora dianteira	← → ↓	Para 1.9 gasolina	<b>11600</b> <b>01.50506.0</b>	96 111 480
15		Bieleta estabilizadora delantera Front stabiliser rod Biellette de stabilisateur avant Biela estabilizadora dianteira	← → ↓	Todos los modelos	<b>11589</b> <b>01.02203.0</b>	5087.46
16		Silent-block brazo suspensión Silent-block arm support Silentbloc du bras de suspension Sino-bloco do braço da suspensão	← → ↓	Todos los modelos Excepto 1.1,40kW, 1.4 D, 1.5 D	<b>27924</b>	3523.75
17		Silent-block barra estabilizadora Rubber mounting Support en caoutchouc Suporte goma (Sino-bloco) estabilizador	← → ↓	Ø19mm Todos los modelos Excepto 1.1,40kW, 1.4 D, 1.5 D	<b>26571</b>	5094.66
18		Silent-block barra estabilizadora Rubber mounting Support en caoutchouc Suporte goma (Sino-bloco) estabilizador	← → ↓	Ø21mm Todos los modelos Excepto 1.1,40kW, 1.4 D, 1.5 D	<b>26577</b>	5094.65







**RÓTULAS, BRAZOS DE SUSPENSIÓN Y BIELETAS**

*ROTULES, BRAS DE SUSPENSION ET BIELLETES*

TIE ROD ENDS, SUSPENSION ARMS AND CONNECTING RODS

N2

03/1991 - 10/1997









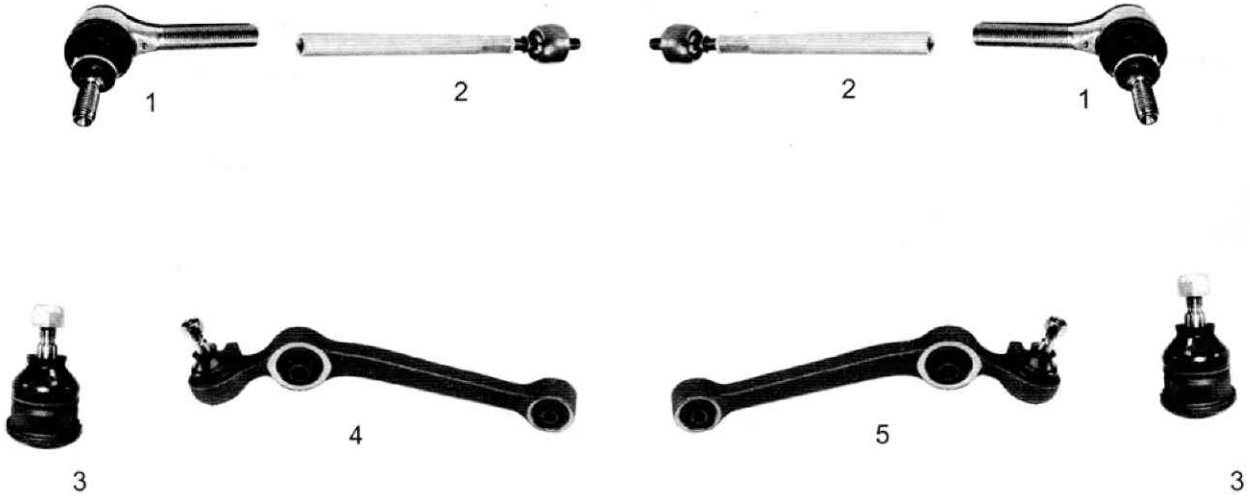





					REF. O.E.
19	 <p>Soporte de goma (Silentblock) Rubber mounting Support en caoutchouc Suporte goma (Sino-bloco)</p>		<p>Todos los modelos Excepto 1.1,40kW, 1.4 D, 1.5 D</p>	<p><b>19307</b></p>	5131.69
20	 <p>Soporte de goma (Silentblock) Rubber mounting Support en caoutchouc Suporte goma (Sino-bloco)</p>		<p>Todos los modelos Excepto 1.1,40kW, 1.4 D, 1.5 D</p>	<p><b>19257</b></p>	5131 70

**RÓTULAS, BRAZOS DE SUSPENSIÓN Y BIELETAS**
*ROTULES, BRAS DE SUSPENSION ET BIELLETES*

## TIE ROD ENDS, SUSPENSION ARMS AND CONNECTING RODS

1980 |--&gt;



					REF. O.E.
1		Rótula dirección Steering ball joint Rotule de direction Rótula de direcção	 	← →	<b>12070</b> 3817.10 <b>01.00924.1</b>
2		Rótula axial Axial ball joint Rotule axiale Rótula axial	 	← →	<b>12282</b> - <b>01.00931.1</b>
3		Rótula suspensión inferior Lower suspension ball joint Rotule de suspension inférieure Rótula da suspensão inferior	 	← → ↓	<b>15613</b> - <b>01.00053.0</b>
4		Brazo suspensión inferior Lower suspension arm Bras de suspension inférieur Braço da suspensão inferior	 	← ↓	<b>17408</b> 3520.34 <b>01.00061.0</b>
5		Brazo suspensión inferior Lower suspension arm Bras de suspension inférieur Braço da suspensão inferior	 	→ ↓	<b>17409</b> 3521.23 <b>01.00060.0</b>





**RÓTULAS, BRAZOS DE SUSPENSIÓN Y BIELETAS**

*ROTULES, BRAS DE SUSPENSION ET BIELLETES*

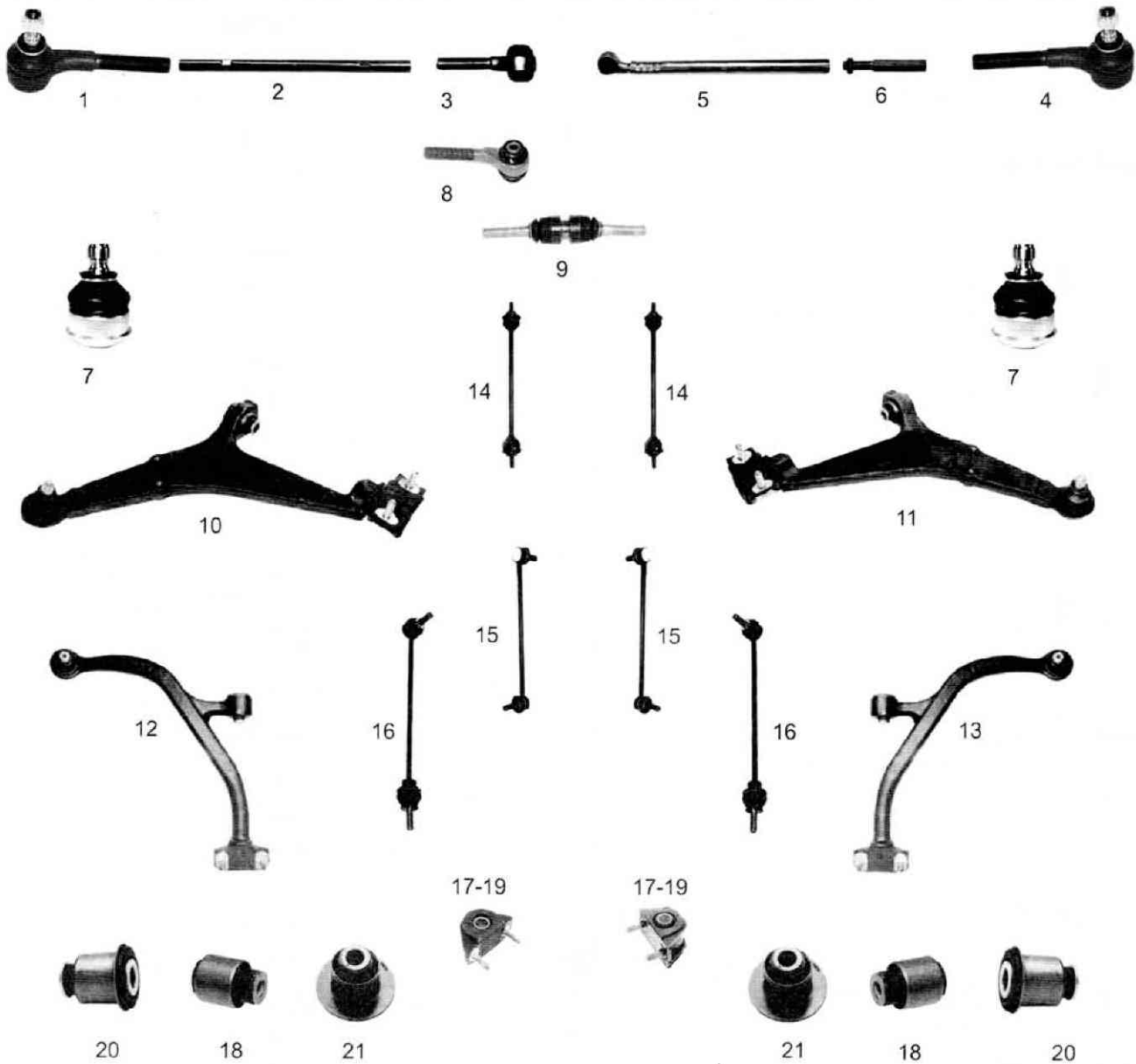
TIE ROD ENDS, SUSPENSION ARMS AND CONNECTING RODS















09/1991 - 04/1996



					REF. O.E.
1	 Rótula direcció Steering ball joint Rotule de direction Rótula de direccão	←			<b>14799</b> 3817.41/30 <b>01.03124.1</b>
2	 Tirante direcció Steering brace Tirant de direction Tirante direccão	←	Direcció		<b>27979</b> 3812.A0 <b>01.02209.0</b>
3	 Tubo unió Connection pipe Tube de jonction Tubo de união	←	Direcció		<b>27983</b> 3817.32 <b>01.02301.0</b>
4	 Rótula direcció Steering ball joint Rotule de direction Rótula de direccão		→		<b>14800</b> 3817.42/31 <b>01.03125.1</b>

SUSPENSION, DIRECCION Y TRANSMISION / SUSPENSION, TRANSMISSION ET DIRECTION / SUSPENSION, TRANSMISSION AND STEERING

**RÓTULAS, BRAZOS DE SUSPENSIÓN Y BIELETAS**
**ROTULES, BRAS DE SUSPENSION ET BIELLETES**
**TIE ROD ENDS, SUSPENSION ARMS AND CONNECTING RODS**
**09/1991 - 04/1996**









5		Tubo unión Connection pipe Tube de jonction Tubo de união	→ Dirección	<b>27982</b> <b>01.02300.0</b>	3817.35	
6		Tubo unión Connection pipe Tube de jonction Tubo de união	→ Ajuste Dirección	<b>27984</b> <b>01.02302.0</b>	3817.34	
7		Rótula suspensión inferior Lower suspension ball joint Rotule de suspension inférieure Rótula da suspensão inferior	← → ↓	Todos los modelos <b>15334</b> <b>01.50501.0</b>	3640.36	17434 17433 26736 ...
8		Tirante dirección Steering brace Tirant de direction Tirante direcção	←	Excepto 1.4 <b>22327</b> <b>01.02207.0</b>	3817.33	
9		Rótula axial central Axial ball joint centre Rotule axiale centrale Rótula axial central	✱	<b>25256</b>	3817.47	
10		Brazo suspensión inferior Lower suspension arm Bras de suspension inférieure Braço da suspensão inferior	← ↓	Mod. 1.0, 1.1, 1.4D y 1.5D <b>17433</b> <b>02.05119.0</b>	3520.78	15334 17452 24512
11		Brazo suspensión inferior Lower suspension arm Bras de suspension inférieure Braço da suspensão inferior	↓	Mod. 1.0, 1.1, 1.4D y 1.5D <b>17434</b> <b>02.05118.0</b>	3520.79	15334 17452 24512
12		Brazo suspensión inferior Lower suspension arm Bras de suspension inférieure Braço da suspensão inferior	↓	Mod. 1.3, 1.4 69kw y 1.6 03/1993  --> <b>26735</b> <b>02.05213.0</b>	3520.93	15334 24515 17451
13		Brazo suspensión inferior Lower suspension arm Bras de suspension inférieure Braço da suspensão inferior	← ↓	Mod. 1.3, 1.4 69kw y 1.6 03/1993  --> <b>26736</b> <b>02.05214.0</b>	3520.92	15334 24515 17451
14		Bieleta estabilizadora delantera Front stabiliser rod Biellette de stabilisateur avant Biela estabilizadora dianteira	← →	-->  05/1995 <b>19306</b> <b>01.02616.0</b>	5087.33	
15		Bieleta estabilizadora delantera Front stabiliser rod Biellette de stabilisateur avant Biela estabilizadora dianteira	← →	<b>22724</b> <b>01.02200.0</b>	5087.48	
16		Bieleta estabilizadora delantera Front stabiliser rod Biellette de stabilisateur avant Biela estabilizadora dianteira	← →	05/1995  --> <b>17464</b> <b>01.03518.1</b>	5087.40	
17		Soporte de goma (Silentblock) Rubber mounting Support en caoutchouc Suporte goma (Sino-bloco)	← →	<b>17452</b>	3523.51	17433 17434
18		Silent-block brazo suspensión Silent-block arm support Silentbloc du bras de suspension Sino-bloco do braço da suspensão	← → ↓	<b>24512</b>	3523.50	17433 17434

**RÓTULAS, BRAZOS DE SUSPENSIÓN Y BIELETAS**

*ROTULES, BRAS DE SUSPENSION ET BIELLETES*

TIE ROD ENDS, SUSPENSION ARMS AND CONNECTING RODS







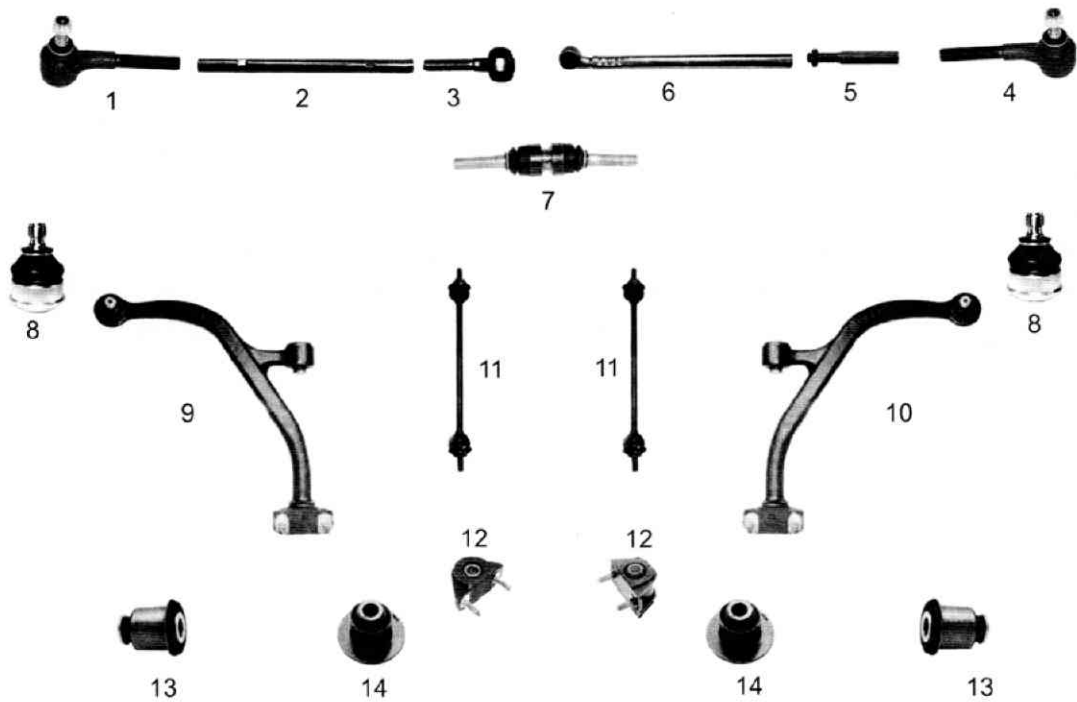

09/1991 - 04/1996

19		Silent-block brazo suspensión Silent-block arm support Silentbloc du bras de suspension Sino-bloco do braço da suspensão		<b>24515</b>	96 148 480	26736 26735
20		Silent-block brazo suspensión Silent-block arm support Silentbloc du bras de suspension Sino-bloco do braço da suspensão		<b>17451</b>	3523.52	26736 26735
			 		<b>REF. O.E.</b>	
21		Soporte de cuerpo de eje Axle body mounting Support de corps de l'essieu Suporte goma corpo do eixo		<b>22509</b>	5131 63	

**RÓTULAS, BRAZOS DE SUSPENSIÓN Y BIELETAS**
**ROTULES, BRAS DE SUSPENSION ET BIELLETES**
**TIE ROD ENDS, SUSPENSION ARMS AND CONNECTING RODS**

04/1996 |--&gt;









					REF. O.E.
1		Rótula dirección Steering ball joint Rotule de direction Rótula de direcção	←		<b>14799</b> 3817.41/30 01.03124.1
2		Tirante dirección Steering brace Tirant de direction Tirante direcção	←		<b>27979</b> 3812.A0 01.02209.0
3		Tirante dirección Steering brace Tirant de direction Tirante direcção	←	Excepto 1.1 i y 1.4 Enterprise	<b>22327</b> 3817.33 01.02207.0
4		Rótula dirección Steering ball joint Rotule de direction Rótula de direcção	→		<b>14800</b> 3817.42/31 01.03125.1
5		Tubo unión Connection pipe Tube de jonction Tubo de união	→	Ajuste Dirección	<b>27984</b> 3817.34 01.02302.0
6		Tirante dirección Steering brace Tirant de direction Tirante de direcção	→		<b>27981</b> 3817.36 01.02208.0
7		Rótula axial central Axial ball joint centre Rotule axiale centrale Rótula axial central	*	Excepto 1.1 i Enterprise	<b>25256</b> 3817 47
8		Rótula suspensión inferior Lower suspension ball joint Rotule de suspension inférieure Rótula da suspensão inferior	↔ ↓	Excepto 1.1 i Enterprise	<b>15334</b> 3640.36 01.50501.0 17434 17433 26736 ...

## RÓTULAS, BRAZOS DE SUSPENSIÓN Y BIELETAS

ROTULES, BRAS DE SUSPENSION ET BIELLETES

TIE ROD ENDS, SUSPENSION ARMS AND CONNECTING RODS







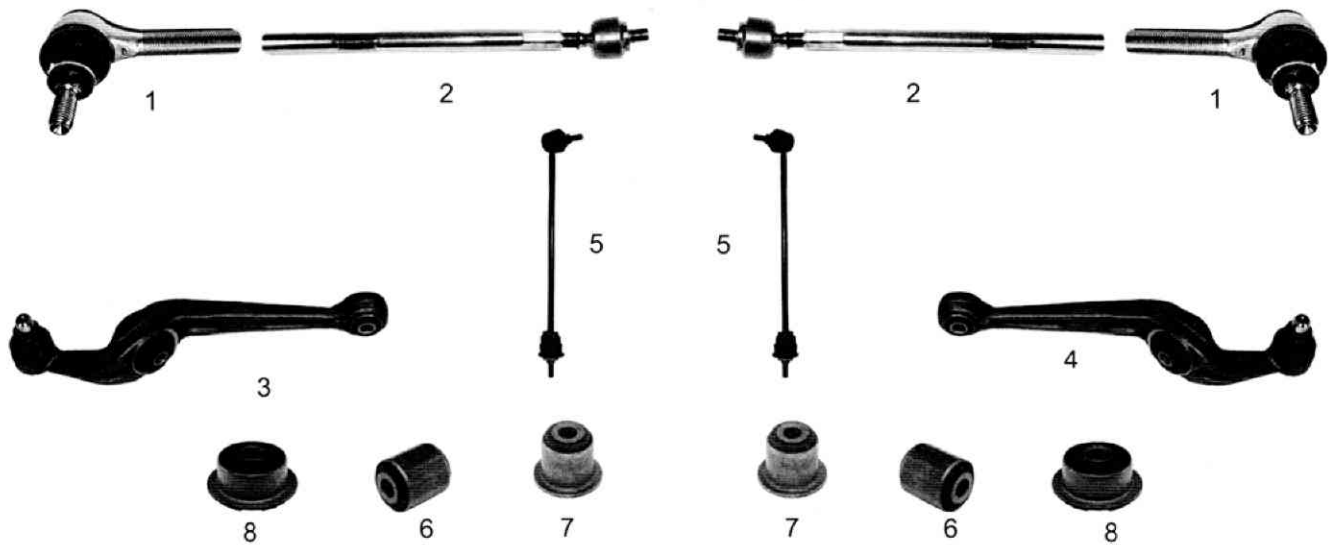

04/1996 |--&gt;

9		Brazo suspensión inferior Lower suspension arm Bras de suspension inférieur Braço da suspensão inferior	← ↓	Mod. 1.4 i y 1.6 i. Mod. 1.1 i para vehículos con Susp. Deportiva	<b>26736</b> <b>02.05214.0</b>	3520.80 15334 24515 17451
10		Brazo suspensión inferior Lower suspension arm Bras de suspension inférieur Braço da suspensão inferior	→ ↓	Mod. 1.4 i y 1.6 i. Mod. 1.1 i para vehículos con Susp. Deportiva	<b>26735</b> <b>02.05213.0</b>	3520.81 15334 24515 17451
11		Bieleta estabilizadora delantera Front stabiliser rod Biellette de stabilisateur avant Biela estabilizadora dianteira	← →		<b>19306</b> <b>01.02616.0</b>	5087.33
12		Silent-block brazo suspensión Silent-block arm support Silentbloc du bras de suspension Sino-bloco do braço da suspensão	← →		<b>24515</b>	96 148 480 26736 26735
13		Silent-block brazo suspensión Silent-block arm support Silentbloc du bras de suspension Sino-bloco do braço da suspensão	← →		<b>17451</b>	3523.52 26736 26735
14		Soporte de cuerpo de eje Axle body mounting Support de corps de l'essieu Suporte goma corpo do eixo	← →		<b>22509</b>	5131 63

**RÓTULAS, BRAZOS DE SUSPENSIÓN Y BIELETAS**
**ROTULES, BRAS DE SUSPENSION ET BIELLETES**
**TIE ROD ENDS, SUSPENSION ARMS AND CONNECTING RODS**

1983 |--&gt;



					REF. O.E.
1	 Rótula dirección Steering ball joint Rotule de direction Rótula de direcção	← →	Todos los modelos	<b>12070</b> <b>01.00924.1</b>	3817.10 25244 19262
2	 Rótula axial Axial ball joint Rotule axiale Rótula axial	← →	Todos los modelos	<b>11658</b> <b>01.03041.1</b>	3812.25 25244 19262
3	 Brazo suspensión inferior Lower suspension arm Bras de suspension inférieur Braço da suspensão inferior	← ↓	Todos los modelos	<b>12064</b> <b>01.03043.0</b>	3520.51 19247 14766
4	 Brazo suspensión inferior Lower suspension arm Bras de suspension inférieur Braço da suspensão inferior	→ ↓	Todos los modelos	<b>12065</b> <b>01.03042.0</b>	3521.34 19247 14766
5	 Bieleta estabilizadora delantera Front stabiliser rod Bielle de stabilisateur avant Biela estabilizadora dianteira	← →		<b>11588</b> <b>01.03498.1</b>	5087.32
6	 Silent-block brazo suspensión Silent-block arm support Silentbloc du bras de suspension Sino-bloco do braço da suspensão	← ↓		<b>19247</b>	3523 20 12064 12065
7	 Soporte de goma (Silentblock) Rubber mounting Support en caoutchouc Suporte goma (Sino-bloco)	← ↓		<b>22498</b>	3523 31
8	 Soporte de goma (Silentblock) Rubber mounting Support en caoutchouc Suporte goma (Sino-bloco)	← →		<b>14766</b>	3 52 349 12064 12065







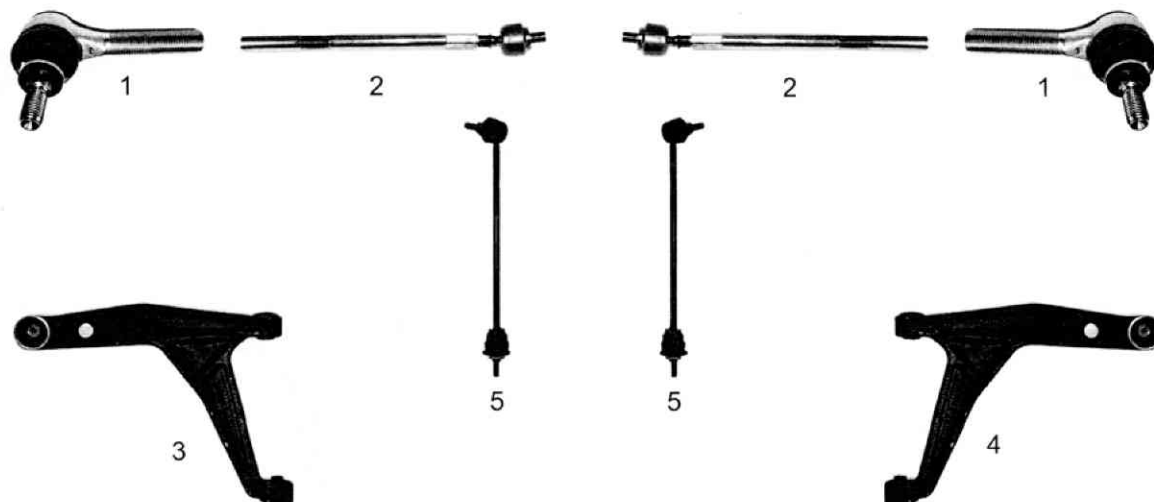

## RÓTULAS, BRAZOS DE SUSPENSIÓN Y BIELETAS

ROTULES, BRAS DE SUSPENSION ET BIELLETES

TIE ROD ENDS, SUSPENSION ARMS AND CONNECTING RODS

1983 |-->









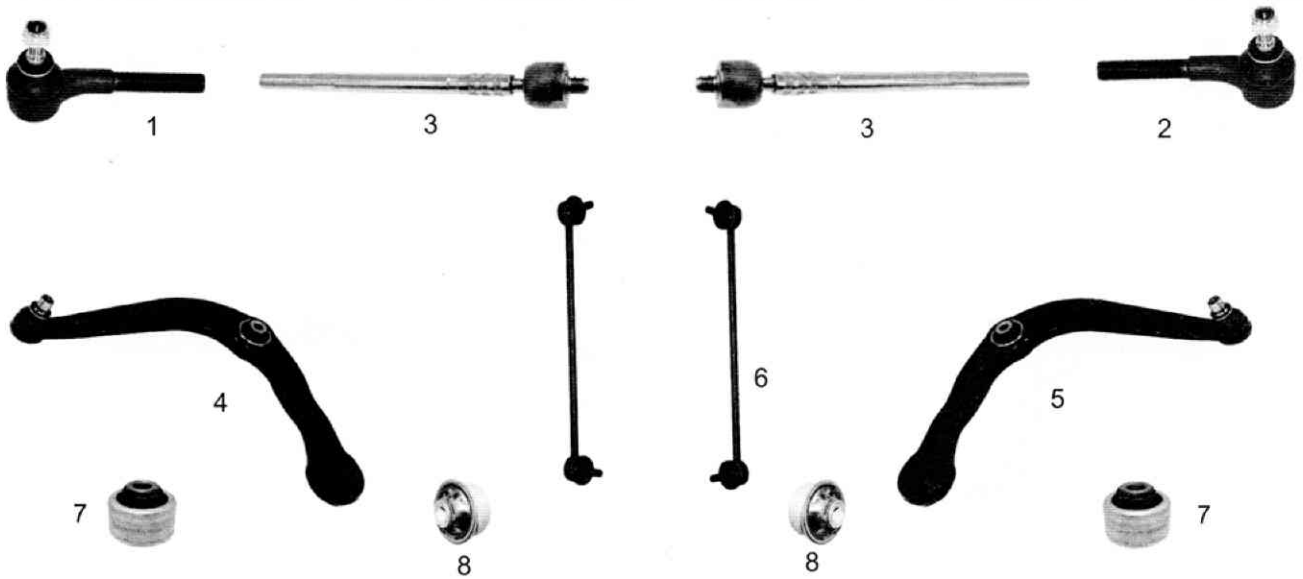

					REF. O.E.
1	 Rótula dirección Steering ball joint Rotule de direction Rótula de direcção	←	→		<b>12070</b> 3817.10 <b>01.00924.1</b>
2	 Rótula axial Axial ball joint Rotule axiale Rótula axial	←	→		<b>11658</b> 3812.25 <b>01.03041.1</b>
3	 Brazo suspensión inferior Lower suspension arm Bras de suspension inférieur Braço da suspensão inferior	←	↓		<b>28077</b> 3520.54 <b>02.05099.0</b>
4	 Brazo suspensión inferior Lower suspension arm Bras de suspension inférieur Braço da suspensão inferior		→	↓	<b>28076</b> 3521.37 <b>02.05098.0</b>
5	 Bieleta estabilizadora delantera Front stabiliser rod Biellette de stabilisateur avant Biela estabilizadora dianteira	←	→		<b>11588</b> 5087.23/32 <b>01.03498.1</b>

**RÓTULAS, BRAZOS DE SUSPENSIÓN Y BIELETAS**
**ROTULES, BRAS DE SUSPENSION ET BIELLETES**
**TIE ROD ENDS, SUSPENSION ARMS AND CONNECTING RODS**

09/1998 |--&gt;



					REF. O.E.
1	 Rótula dirección Steering ball joint Rotule de direction Rótula de direção	→	Todos los modelos	<b>14799</b> 01.03124.1	3817.41
2	 Rótula dirección Steering ball joint Rotule de direction Rótula de direção	←	Todos los modelos	<b>14800</b> 01.03125.1	3817.42
3	 Rótula axial Axial ball joint Rotule axiale Rótula axial	← →	Excepto 1.4 16V, 2.0 RC y 1.6 Hdi FAP 110	<b>25502</b> 01.02306.0	3812.C5
4	 Brazo suspensión inferior Lower suspension arm Bras de suspension inférieur Braço da suspensão inferior	← ↓	Mod. 1.1/1.4/1.6/1.4D 1.9D/2.0D	<b>25177</b> 02.05492.0	3520.G8 29377 28899
5	 Brazo suspensión inferior Lower suspension arm Bras de suspension inférieur Braço da suspensão inferior	← ↓	Mod. 1.1/1.4/1.6/1.4D 1.9D/2.0D	<b>25178</b> 02.05493.0	3521.C8 29377 28899
6	 Bieleta estabilizadora delantera Front stabiliser rod Biellette de stabilisateur avant Biela estabilizadora dianteira	← →	Excepto 1.4 16V, 2.0 RC y 1.6 Hdi FAP 110	<b>22651</b> 01.02309.0	5087.45
7	 Silent-block brazo suspensión Silent-block arm support Silentbloc du bras de suspension Sino-bloco do braço da suspensão	← → ↓		<b>29377</b>	3523 76 25177 25178
8	 Silent-block brazo suspensión Silent-block arm support Silentbloc du bras de suspension Sino-bloco do braço da suspensão	← → ↓		<b>28899</b>	3523 92 25177 25178





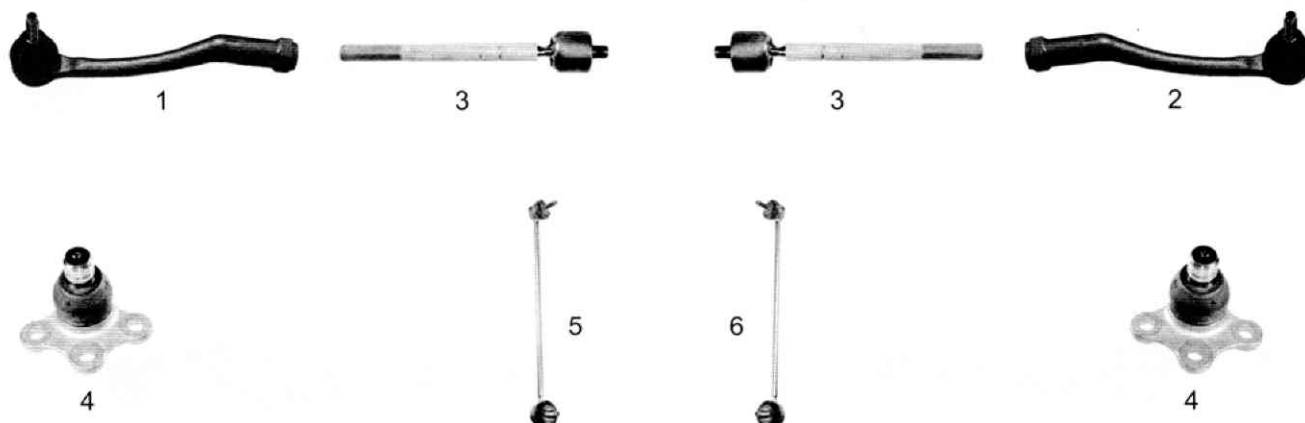

## RÓTULAS, BRAZOS DE SUSPENSIÓN Y BIELETAS

ROTULES, BRAS DE SUSPENSION ET BIELLETES

TIE ROD ENDS, SUSPENSION ARMS AND CONNECTING RODS

02/2006 |-->







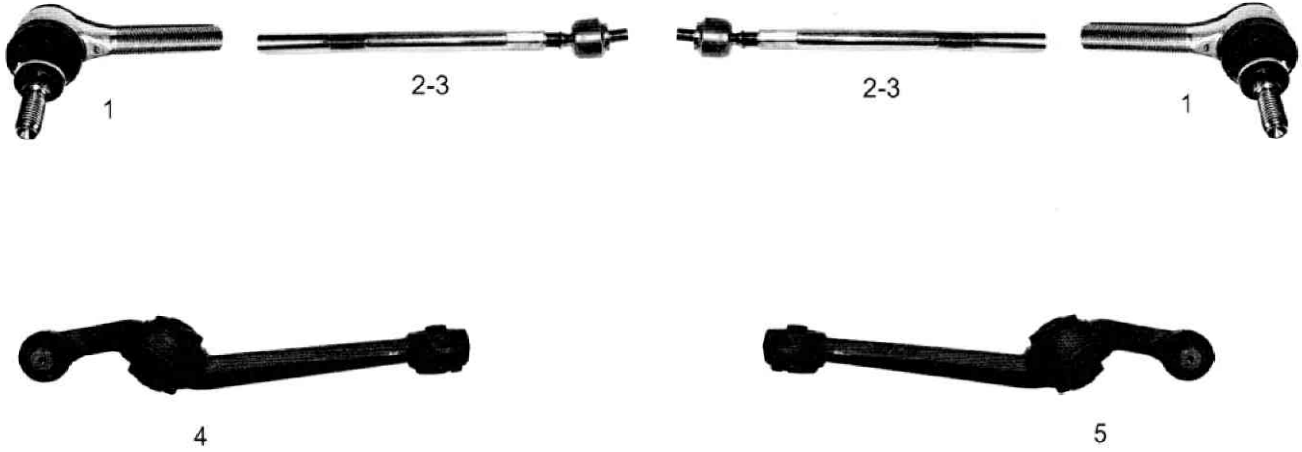

					REF. O.E.
1		Rótula dirección Steering ball joint Rotule de direction Rótula de direcção	←		<b>30602</b> 3817 67
2		Rótula dirección Steering ball joint Rotule de direction Rótula de direcção		→	<b>30603</b> 3817 68
3		Rótula axial Axial ball joint Rotule axiale Rótula axial	←	→	<b>30604</b> 3812 E8
4		Rótula suspensión inferior Lower suspension ball joint Rotule de suspension inférieure Rótula da suspensão inferior	←	→ ↓	<b>30452</b> 3640 61
5		Bieleta estabilizadora Stabiliser rod Biellette de stabilisateur Biela estabilizadora	←		<b>30667</b> 5087 54
6		Bieleta estabilizadora Stabiliser rod Biellette de stabilisateur Biela estabilizadora		→	<b>30668</b> 5087 55

**RÓTULAS, BRAZOS DE SUSPENSIÓN Y BIELETAS**
*ROTULES, BRAS DE SUSPENSION ET BIELLETES*

## TIE ROD ENDS, SUSPENSION ARMS AND CONNECTING RODS

1977 - 1982



					REF. O.E.	
1		Rótula dirección Steering ball joint Rotule de direction Rótula de direcção	← →		<b>12070</b> 01.00924.1	3817.10
2		Rótula axial Axial ball joint Rotule axiale Rótula axial	← →	Ch N° 8139333  --> y (Mod 304 Años 1977-1982) L2-315mm M12x1/M14x1,5mm	<b>11658</b> 01.03041.1	3812.25
3		Rótula axial Axial ball joint Rotule axiale Rótula axial	← →	305 -->  Ch N° 8139332 L2-316mm M12x1/14x1,5mm	<b>19304</b> 01.00101.1	3812.09
4		Brazo suspensión inferior Lower suspension arm Bras de suspension inférieur Braço da suspensão inferior	← ↓		<b>17501</b> 01.50801.0	3520.37
5		Brazo suspensión inferior Lower suspension arm Bras de suspension inférieur Braço da suspensão inferior	← ↓ →		<b>12066</b> 01.50800.0	3521.26

## RÓTULAS, BRAZOS DE SUSPENSIÓN Y BIELETAS

ROTULES, BRAS DE SUSPENSION ET BIELLETES

TIE ROD ENDS, SUSPENSION ARMS AND CONNECTING RODS

1982 - 1984

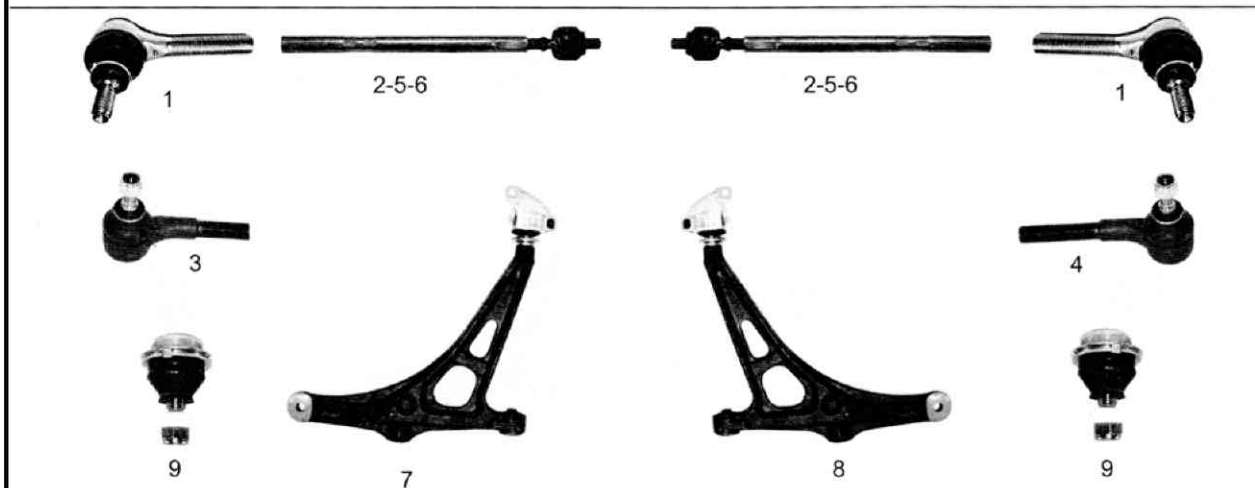





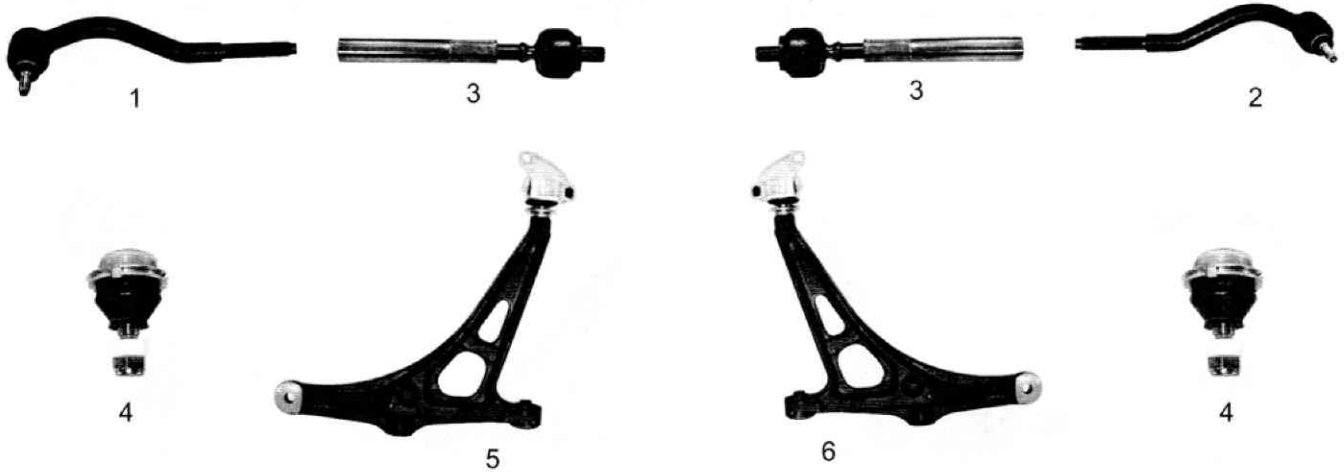

					REF. O.E.
	1 Rótula dirección Steering ball joint Rotule de direction Rótula de direcção	← →	1982 - 1984	<b>12070</b> 01.00924.1	3817.10/18
	2 Rótula axial Axial ball joint Rotule axiale Rótula axial	← →	1982 - 1984	<b>19304</b> 01.00101.1	3812.09
	3 Rótula dirección Steering ball joint Rotule de direction Rótula de direcção	←	1982  → Mod. 1.3/1.5	<b>14799</b> 01.03124.1	3817.41
	4 Rótula dirección Steering ball joint Rotule de direction Rótula de direcção	→	1982  → Mod. 1.3/1.5	<b>14800</b> 01.03125.1	3817.42
	5 Rótula axial Axial ball joint Rotule axiale Rótula axial	← →	Mod. 1.3, 1.5, 1.6 y 1.9	<b>11658</b> 01.03041.1	3812.95
	6 Rótula axial Axial ball joint Rotule axiale Rótula axial	← →		<b>12282</b> 01.00931.1	79100300
	7 Brazo suspensión inferior Lower suspension arm Bras de suspension inférieur Braço da suspensão inferior	← ↓		<b>02.05179.0</b>	3520.63
	8 Brazo suspensión inferior Lower suspension arm Bras de suspension inférieur Braço da suspensão inferior	↓ →		<b>02.05178.0</b>	3521.44
	9 Rótula suspensión inferior Lower suspension ball joint Rotule de suspension inférieure Rótula da suspensão inferior	← → ↓	Todos los modelos	<b>11586</b> 01.03020.0	96 041 652

**RÓTULAS, BRAZOS DE SUSPENSIÓN Y BIELETAS**
*ROTULES, BRAS DE SUSPENSION ET BIELLETES*

## TIE ROD ENDS, SUSPENSION ARMS AND CONNECTING RODS

1985 |--&gt;



					REF. O.E.
1	 Rótula dirección Steering ball joint Rotule de direction Rótula de direcção	←	Mod. 1.6/1.9/1.9D 09/1985  --> Ch N° 9730001  -->	<b>12073</b> <b>01.03045.1</b>	3817.21/26
2	 Rótula dirección Steering ball joint Rotule de direction Rótula de direcção	→	Mod. 1.6/1.9/1.9D 09/1985  --> Ch N° 9730001  -->	<b>12074</b> <b>01.03044.1</b>	3817.22/27
3	 Rótula axial Axial ball joint Rotule axiale Rótula axial	← →		<b>18208</b> <b>01.00854.1</b>	7702 103 636
4	 Rótula suspensión inferior Lower suspension ball joint Rotule de suspension inférieure Rótula da suspensão inferior	← → ↓	Todos los modelos	<b>11586</b> <b>01.03020.0</b>	3640.21
5	 Brazo suspensión inferior Lower suspension arm Bras de suspension inférieur Braço da suspensão inferior	← ↓		<b>02.05179.0</b>	3520.63
6	 Brazo suspensión inferior Lower suspension arm Bras de suspension inférieur Braço da suspensão inferior	↓ →		<b>02.05178.0</b>	3521.44





**RÓTULAS, BRAZOS DE SUSPENSIÓN Y BIELETAS**

*ROTULES, BRAS DE SUSPENSION ET BIELLETES*

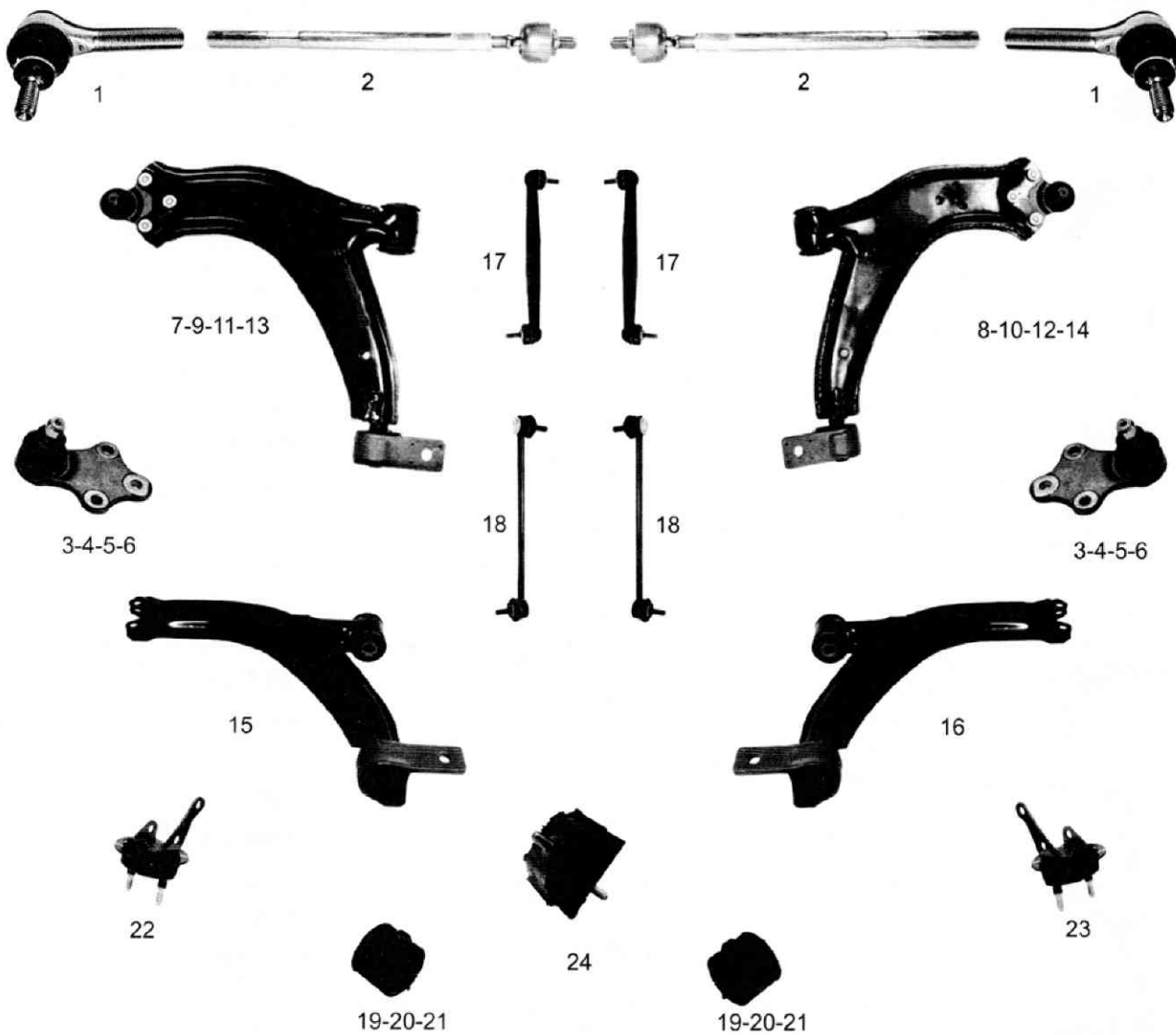
TIE ROD ENDS, SUSPENSION ARMS AND CONNECTING RODS

1993 |-->















		(i)	(i)	REF. O.E.
1	 Rótula dirección Steering ball joint Rotule de direction Rótula de direção	← →	Todos los modelos	<b>12070</b> 3817.10 <b>01.00924.1</b>
2	 Rótula axial Axial ball joint Rotule axiale Rótula axial	← →	Todos los modelos	<b>17515</b> 3812.92 <b>01.50802.0</b>
3	 Rótula suspensión inferior Lower suspension ball joint Rotule de suspension inférieure Rótula da suspensão inferior	← → ↓	Ø16, Dir. Manual 01/1999 -->	<b>14978</b> 3640.31/44 <b>01.50900.0</b> <div style="float: right; border: 1px solid black; padding: 2px;">                         26726                          28078                     </div>
4	 Rótula suspensión inferior Lower suspension ball joint Rotule de suspension inférieure Rótula da suspensão inferior	← → ↓	Ø16, para vehículos con dirección asistida 01/1999 -->	<b>14977</b> 3640.30/37 <b>01.50901.0</b> <div style="float: right; border: 1px solid black; padding: 2px;">                         26727                          26728                     </div>

SUSPENSION, DIRECTION Y TRANSMISION / SUSPENSION, TRANSMISSION ET DIRECTION / SUSPENSION, TRANSMISSION AND STEERING

**RÓTULAS, BRAZOS DE SUSPENSIÓN Y BIELETAS**
*ROTULES, BRAS DE SUSPENSION ET BIELLETES*

## TIE ROD ENDS, SUSPENSION ARMS AND CONNECTING RODS

1993 |--&gt;

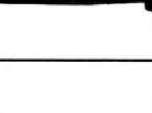
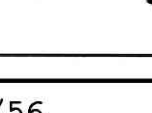
5		Rótula suspensión inferior Lower suspension ball joint Rotule de suspension inférieure Rótula da suspensão inferior	← → ↓	Ø18, Ch N° 07970  -->	<b>26722</b> 01.02554.0	3640.48 28135 28136
6		Rótula suspensión inferior Lower suspension ball joint Rotule de suspension inférieure Rótula da suspensão inferior	← → ↓	Ø18, Mod. 1.1, 1.4 SL, 1.6 SR, 2.0 Ch N° 07970  --> Mod. 1.8 ST y 1.8 Ch N° 08575  --> Mod. 1.9 SLD, 1.9 D, 1.9 SRDT y 2.0 HDI 90 Ch N° 07970 - 08574	<b>26881</b> 01.02080.0	3640.49 28746 28747
7		Brazo suspensión inferior Lower suspension arm Bras de suspension inférieure Braço da suspensão inferior	← ↓	Dir. Manual -->  7969	<b>28078</b> 02.05101.0	3520.83 14978 27711
8		Brazo suspensión inferior Lower suspension arm Bras de suspension inférieure Braço da suspensão inferior	→ ↓	Dir. Manual -->  7969	<b>26726</b> 02.05100.0	3521.55 14978 27712
9		Brazo suspensión inferior Lower suspension arm Bras de suspension inférieure Braço da suspensão inferior	← ↓	Dir. Asistida Todos los modelos Susp. Deportiva	<b>26728</b> 02.05103.0	3520.84 14977 27711
10		Brazo suspensión inferior Lower suspension arm Bras de suspension inférieure Braço da suspensão inferior	→ ↓	Dir. Asistida Todos los modelos Susp. Deportiva	<b>26727</b> 02.05102.0	3521.56 14977 27712
11		Brazo suspensión inferior Lower suspension arm Bras de suspension inférieure Braço da suspensão inferior	← ↓	HDI 7970  -->	<b>28135</b> 02.05511.0	- 26722 27711
12		Brazo suspensión inferior Lower suspension arm Bras de suspension inférieure Braço da suspensão inferior	→ ↓	HDI 7970  -->	<b>28136</b> 02.05512.0	- 26722 27712
13		Brazo suspensión inferior Lower suspension arm Bras de suspension inférieure Braço da suspensão inferior	← ↓	08475  -->	<b>28746</b> 02.05566.0	- 26881 27711
14		Brazo suspensión inferior Lower suspension arm Bras de suspension inférieure Braço da suspensão inferior	→ ↓	08475  -->	<b>28747</b> 02.05567.0	- 26881 27712
15		Brazo suspensión inferior (sin rótula) Lower suspension arm (NO ball joint) Bras de suspension inférieure (Sans Rotule) Braço da suspensão inferior (NO rótula)	← ↓		<b>27711</b> 02.05568.0	- 28078 26728 28135 ...
16		Brazo suspensión inferior (sin rótula) Lower suspension arm (NO ball joint) Bras de suspension inférieure (Sans Rotule) Braço da suspensão inferior (NO rótula)	→ ↓	Con dirección asistida: 14977 o 26881. Sin dirección asistida: 14978 o 26722	<b>27712</b> 02.05569.0	- 26726 26727 28136 ...
17		Bieleta estabilizadora delantera Front stabiliser rod Biellette de stabilisateur avant Biela estabilizadora dianteira	← →	09/1994  -->	<b>19256</b> 01.02310.0	5087.39/42/46
18		Bieleta estabilizadora delantera Front stabiliser rod Biellette de stabilisateur avant Biela estabilizadora dianteira	← →	-->  09/1994	<b>11589</b> 01.02203.0	5087.46

















## RÓTULAS, BRAZOS DE SUSPENSIÓN Y BIELETAS

ROTULES, BRAS DE SUSPENSION ET BIELLETES

TIE ROD ENDS, SUSPENSION ARMS AND CONNECTING RODS

1993 |--&gt;

19		Silent-block barra estabilizadora Rubber mounting Support en caoutchouc Suporte goma (Sino-bloco) estabilizador		Ø17mm	<b>25999</b>	5094 63
20		Silent-block barra estabilizadora Rubber mounting Support en caoutchouc Suporte goma (Sino-bloco) estabilizador		Ø18mm	<b>26563</b>	5094 64
21		Silent-block barra estabilizadora Rubber mounting Support en caoutchouc Suporte goma (Sino-bloco) estabilizador		Ø21mm	<b>26577</b>	5094.65
			 			<b>REF. O.E.</b>
22		Soporte de goma (Silentblock) Rubber mounting Support en caoutchouc Suporte goma (Sino-bloco)		Todos los modelos	<b>19307</b>	5131.69
23		Soporte de goma (Silentblock) Rubber mounting Support en caoutchouc Suporte goma (Sino-bloco)		Todos los modelos	<b>19257</b>	5131 70
24		Soporte de goma (Silentblock) Rubber mounting Support en caoutchouc Suporte goma (Sino-bloco)			<b>11590</b>	5131 71

**RÓTULAS, BRAZOS DE SUSPENSIÓN Y BIELETAS**
**ROTULES, BRAS DE SUSPENSION ET BIELLETES**
**TIE ROD ENDS, SUSPENSION ARMS AND CONNECTING RODS**

08/2000 |--&gt;

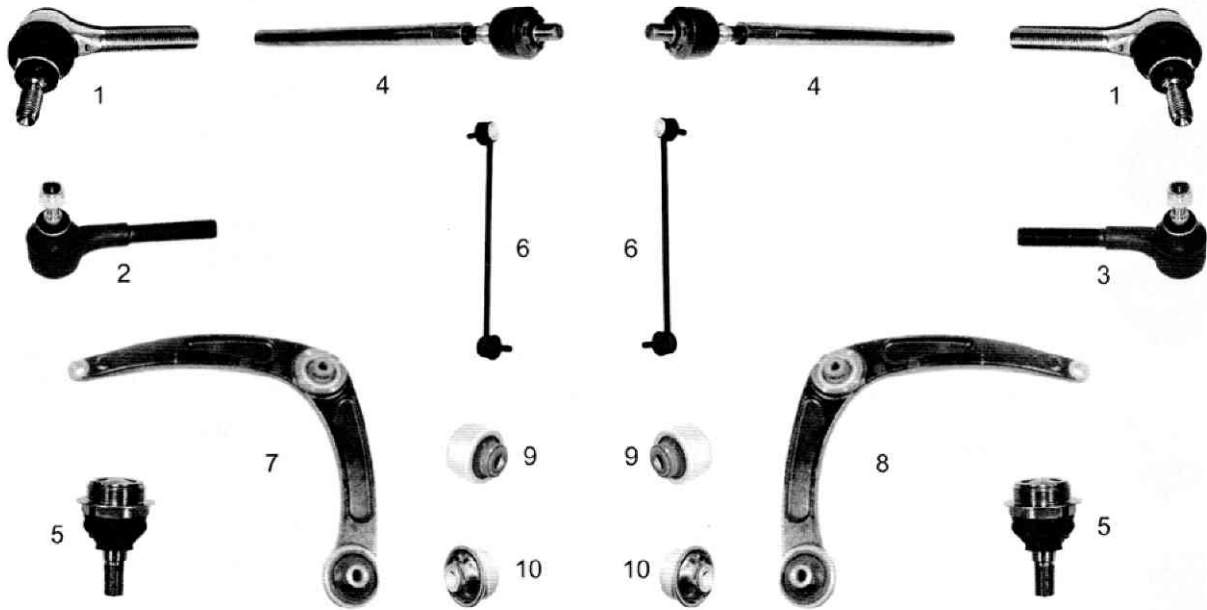



					REF. O.E.
1	 Rótula dirección Steering ball joint Rotule de direction Rótula de direcção	← → Ch Nº 10311  --> Excepto 2.0 16V 103kw y 2.0 16V 130kw	 <b>12070</b> 01.00924.1	3817.50	
2	 Rótula dirección Steering ball joint Rotule de direction Rótula de direcção	→ Ch Nº 10310 -->  Excepto 2.0 16V 103kw y 2.0 16V 130kw	<b>14799</b> 01.03124.1	3817.41	
3	 Rótula dirección Steering ball joint Rotule de direction Rótula de direcção	← Ch Nº 10310 -->  Excepto 2.0 16V 103kw y 2.0 16V 130kw	<b>14800</b> 01.03125.1	3817.42	
4	 Rótula axial Axial ball joint Rotule axiale Rótula axial	← → Ch Nº 10310 -->  Excepto 2.0 16V 103kw y 2.0 16V 130kw	<b>26059</b> 01.02576.0	3812.E0	
5	 Rótula suspensión inferior Lower suspension ball joint Rotule de suspension inférieure Rótula da suspensão inferior	← → ↓ Excepto 2.0 16V 103kw y 2.0 16V 130kw	<b>27299</b> 01.02577.0	3640.53	
6	 Bieleta estabilizadora delantera Front stabiliser rod Biellette de stabilisateur avant Biela estabilizadora dianteira	← → Excepto 2.0 16V 103kw y 2.0 16V 130kw	<b>26653</b>	5087.50	
7	 Brazo suspensión inferior Lower suspension arm Bras de suspension inférieur Braço da suspensão inferior	← ↓	<b>30606</b>	3520 S2 / K8 28898 28899	
8	 Brazo suspensión inferior Lower suspension arm Bras de suspension inférieur Braço da suspensão inferior	→ ↓	<b>30607</b>	3521 P3 / G8 28898 28899	

**RÓTULAS, BRAZOS DE SUSPENSIÓN Y BIELETAS**

*ROTULES, BRAS DE SUSPENSION ET BIELLETES*

TIE ROD ENDS, SUSPENSION ARMS AND CONNECTING RODS

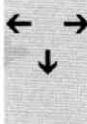

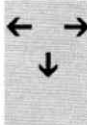





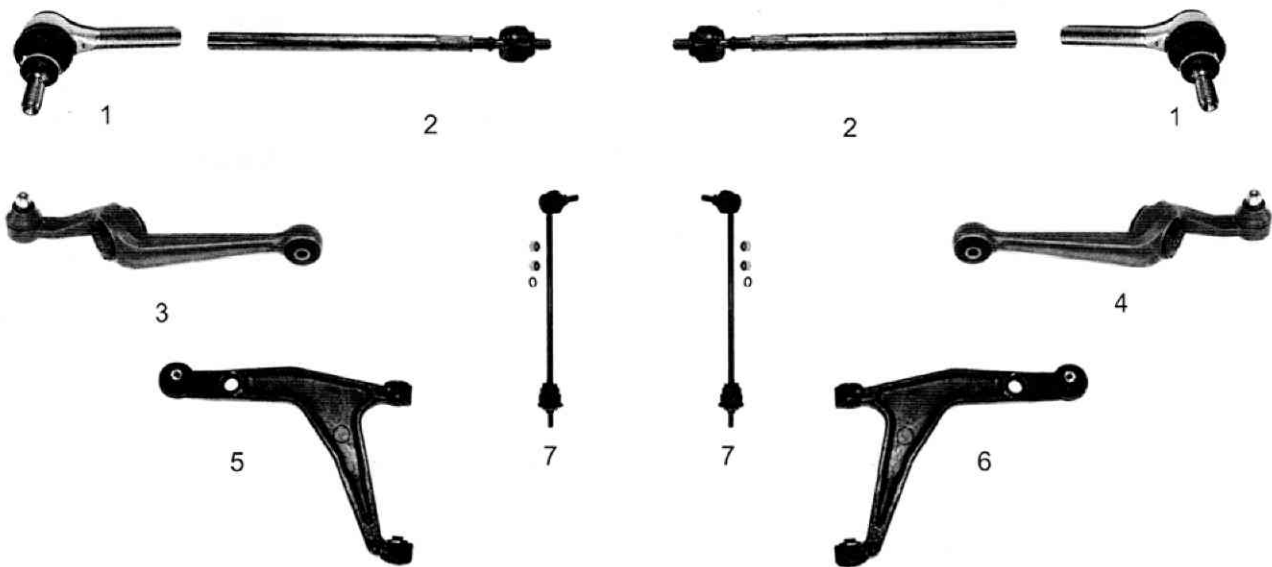









08/2000 |-->

9		<p>Silent-block brazo suspensión                  Silent-block arm support                  Silentbloc du bras de suspension                  Sino-bloco do braço da suspensão</p>		<p>Excepto 2.0 16V 103kw y 2.0 16V 130kw</p>	<p><b>28898</b></p>	<p>3523 91</p>	<p>30606 30607</p>
10		<p>Silent-block brazo suspensión                  Silent-block arm support                  Silentbloc du bras de suspension                  Sino-bloco do braço da suspensão</p>		<p>Excepto 2.0 16V 103kw y 2.0 16V 130kw</p>	<p><b>28899</b></p>	<p>3523 92</p>	<p>30606 30607</p>

**RÓTULAS, BRAZOS DE SUSPENSIÓN Y BIELETAS**
**ROTULES, BRAS DE SUSPENSION ET BIELLETES**
**TIE ROD ENDS, SUSPENSION ARMS AND CONNECTING RODS**

1985 |--&gt;



					REF. O.E.
1	 Rótula dirección Steering ball joint Rotule de direction Rótula de direcção	 ← →	Todos los modelos		<b>12070</b> 3817.10 <b>01.00924.1</b>
2	 Rótula axial Axial ball joint Rotule axiale Rótula axial	 ← →	Todos los modelos		3812.97 <b>01.03070.1</b>
3	 Brazo suspensión inferior Lower suspension arm Bras de suspension inférieur Braço da suspensão inferior	 ← 			<b>17502</b> 3520.57/60 <b>01.03072.0</b>
4	 Brazo suspensión inferior Lower suspension arm Bras de suspension inférieur Braço da suspensão inferior	 → 			<b>17511</b> 3521.41/38 <b>01.03071.0</b>
5	 Brazo suspensión inferior Lower suspension arm Bras de suspension inférieur Braço da suspensão inferior	 ← 	Mod. GTI y TD		<b>28150</b> 3520.64 <b>02.05105.0</b>
6	 Brazo suspensión inferior Lower suspension arm Bras de suspension inférieur Braço da suspensão inferior	 → 	Mod. GTI y TD		<b>28140</b> 3521.45 <b>02.05104.0</b>
7	 Bieleta estabilizadora delantera Front stabiliser rod Bielle de stabilisateur avant Biela estabilizadora dianteira	 ← →	Mod. 1.9 GTI y GTI 16V		<b>11588</b> 5087.23 <b>01.03498.1</b>







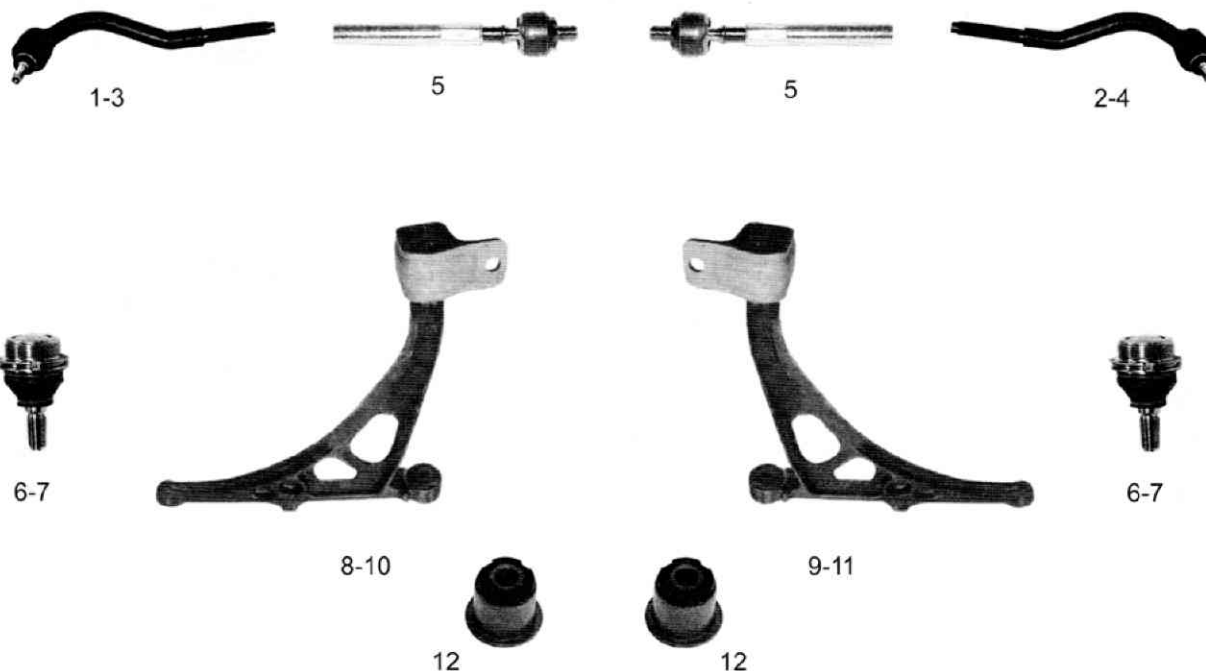

## RÓTULAS, BRAZOS DE SUSPENSIÓN Y BIELETAS

ROTULES, BRAS DE SUSPENSION ET BIELLETES

TIE ROD ENDS, SUSPENSION ARMS AND CONNECTING RODS

10/1988 - 10/1995







					REF. O.E.
1		Rótula dirección Steering ball joint Rotule de direction Rótula de direcção	←	Excepto 1.8, 2.0 y 2.0 16v MI16	<b>12073</b> 3817.21/26 <b>01.03045.1</b>
2		Rótula dirección Steering ball joint Rotule de direction Rótula de direcção	→	Excepto 1.8, 2.0 y 2.0 16v MI16	<b>12074</b> 3817.22/27 <b>01.03044.1</b>
3		Rótula dirección Steering ball joint Rotule de direction Rótula de direcção	←	para vehículos con dirección asistida Mod. 2.0 T 16X4 09/1993  -->	<b>25508</b> 3817 59 <b>01.02586.0</b>
4		Rótula dirección Steering ball joint Rotule de direction Rótula de direcção	→	para vehículos con dirección asistida Mod. 2.0 T 16X4 09/1993  -->	<b>25509</b> 3817 60 <b>01.02587.0</b>
5		Rótula axial Axial ball joint Rotule axiale Rótula axial	← →	Excepto 1.8, 2.0 y 2.0 16v MI16	<b>19249</b> 3812.98 <b>01.03046.1</b>
6		Rótula suspensión inferior Lower suspension ball joint Rotule de suspension inférieure Rótula da suspensão inferior	← → ↓	Excepto 1.8, 2.0 y 2.0 16v MI16 Ch N° S71358279 -->  Ø16mm M38x1,5mm (para Ø13mm menor)	<b>11586</b> 3640.21 <b>01.03020.0</b>
7		Rótula suspensión inferior Lower suspension ball joint Rotule de suspension inférieure Rótula da suspensão inferior	← → ↓	Excepto 1.8, 2.0 y 2.0 16v MI16 Ch N° S 71358280 --> Ø17,5mm M40x1,5mm (para Ø15mm menor)	<b>11592</b> 3640.34 <b>01.50516.0</b>
8		Brazo suspensión inferior Lower suspension arm Bras de suspension inférieure Braço da suspensão inferior	← → ↓	Excepto 1.8, 2.0 y 2.0 16v MI16 Ø13mm	<b>26725</b> 3520.65/68 <b>02.05095.0</b> <span style="border: 1px solid black; padding: 2px;">14798</span>

**RÓTULAS, BRAZOS DE SUSPENSIÓN Y BIELETAS**
*ROTULES, BRAS DE SUSPENSION ET BIELLETES*

## TIE ROD ENDS, SUSPENSION ARMS AND CONNECTING RODS

**10/1988 - 10/1995**

9		Brazo suspensión inferior Lower suspension arm Bras de suspension inférieur Braço da suspensão inferior	→ ↓	Excepto 1.8, 2.0 y 2.0 16v MI16 Ø13mm	<b>26724</b> <b>02.05094.0</b>	3521.46/49 14798
10		Brazo suspensión inferior Lower suspension arm Bras de suspension inférieur Braço da suspensão inferior	← ↓	1993  --> Ch N° S 71358280  --> Ø15mm	<b>27050</b> <b>02.05219.0</b>	3520.47 14798
11		Brazo suspensión inferior Lower suspension arm Bras de suspension inférieur Braço da suspensão inferior	→ ↓	1993  --> Ch N° S 71358280  --> Ø15mm	<b>27051</b> <b>02.05220.0</b>	3521.76 14798
12		Silent-block brazo suspensión Silent-block arm support Silentbloc du bras de suspension Sino-bloco do braço da suspensão	← → ↓		<b>14798</b>	3523 40 26725 26724 27051 ...

RÓTULAS, BRAZOS DE SUSPENSIÓN Y BIELETAS

ROTULES, BRAS DE SUSPENSION ET BIELLETES

TIE ROD ENDS, SUSPENSION ARMS AND CONNECTING RODS



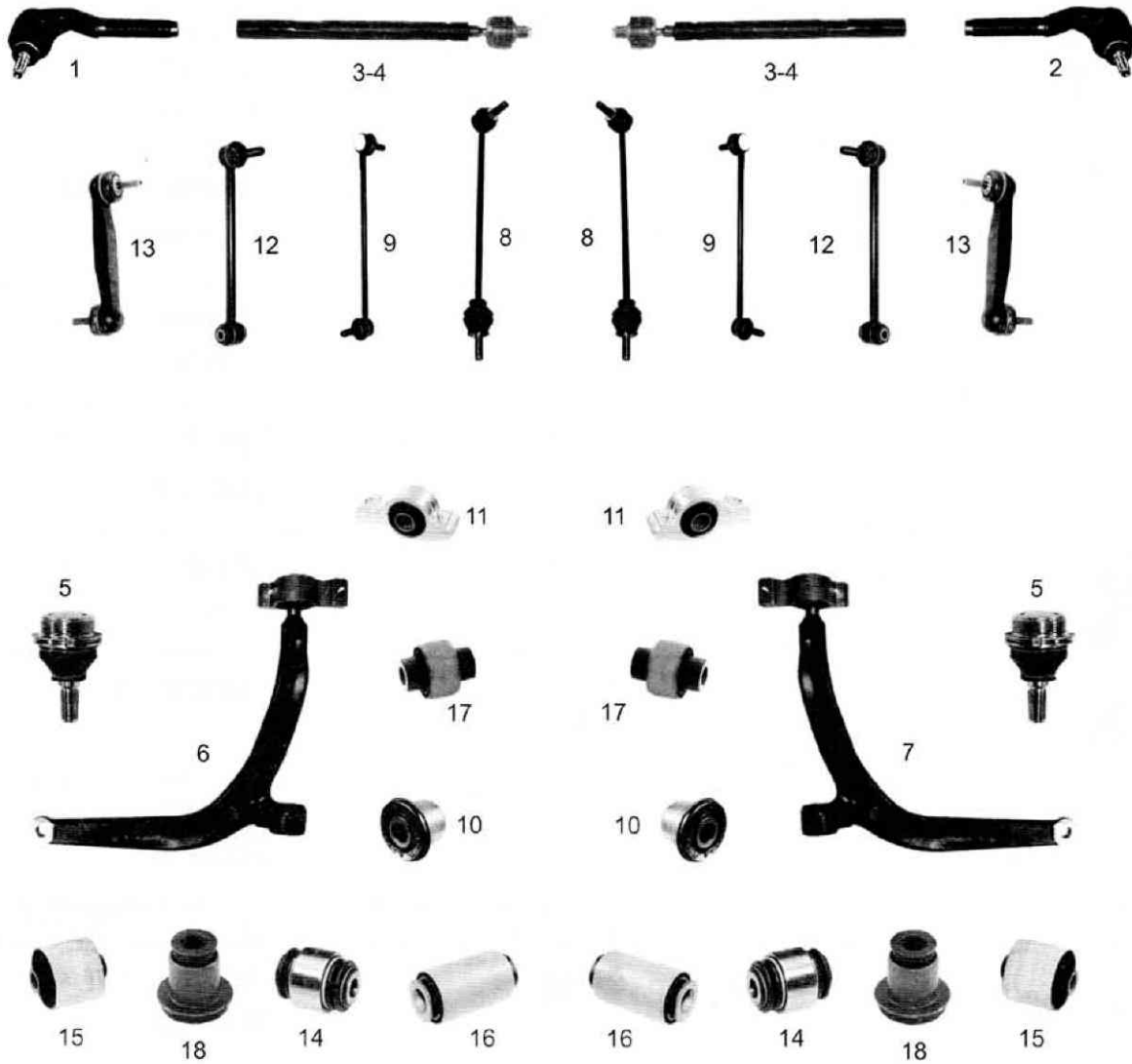











10/1995 - 05/2004



					REF. O.E.
1		Rótula dirección Steering ball joint Rotule de direction Rótula de direcção	←	Todos los modelos	<b>24723</b> 3817.40 <b>01.03791.1</b>
2		Rótula dirección Steering ball joint Rotule de direction Rótula de direcção	→	Todos los modelos	<b>24722</b> 3817.39 <b>01.03790.1</b>
3		Rótula axial Axial ball joint Rotule axiale Rótula axial	← →	Todos los modelos -->  10/1998 L2-313mm M12x1/16x1,5mm	<b>22346</b> 3812.C4 <b>01.03792.1</b>
4		Rótula axial Axial ball joint Rotule axiale Rótula axial	← →	Ø22mm para vehículos con dirección asistida 10/1998  -->	<b>25493</b> 3812.A9

SUSPENSION, DIRECTION Y TRANSMISION / SUSPENSION, TRANSMISSION ET DIRECTION / SUSPENSION, TRANSMISSION AND STEERING

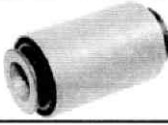
**RÓTULAS, BRAZOS DE SUSPENSIÓN Y BIELETAS**
**ROTULES, BRAS DE SUSPENSION ET BIELLETES**
**TIE ROD ENDS, SUSPENSION ARMS AND CONNECTING RODS**
**10/1995 - 05/2004**

5		Rótula suspensión inferior Lower suspension ball joint Rotule de suspension inférieure Rótula da suspensão inferior	← → ↓	Todos los modelos Ch N° S 71358280 -->	<b>11592</b> <b>01.50516.0</b>	3640.34
6		Brazo suspensión inferior Lower suspension arm Bras de suspension inférieur Braço da suspensão inferior	← → ↓		<b>26737</b> <b>02.05215.0</b>	3520.C0
7		Brazo suspensión inferior Lower suspension arm Bras de suspension inférieur Braço da suspensão inferior	← → ↓		<b>26738</b> <b>02.05216.0</b>	3521.80
8		Bieleta estabilizadora delantera Front stabiliser rod Biellette de stabilisateur avant Biela estabilizadora dianteira	← →	Ch N° 07664 -->  L-323mm M12x1,75mm	<b>17464</b> <b>01.03518.1</b>	5087.40
9		Bieleta estabilizadora delantera Front stabiliser rod Biellette de stabilisateur avant Biela estabilizadora dianteira	← →	Ch N° 07665  --> L-320mm M12mm	<b>22724</b> <b>01.02200.0</b>	5087.43/48
10		Silent-block brazo suspensión Silent-block arm support Silentbloc du bras de suspension Sino-bloco do braço da suspensão	← → ↓	Excepto 1.8 16V	<b>29374</b>	3523 78
11		Silent-block brazo suspensión Silent-block arm support Silentbloc du bras de suspension Sino-bloco do braço da suspensão	← → ↓	Excepto 1.8 16V	<b>29375</b>	3523 61
12		Tirante suspensión Suspension brace Tirant de suspension Tirante da suspensão	← →	Todos los modelos	<b>24726</b> <b>01.02558.0</b>	5178.39/96 287 831
			 			<b>REF. O.E.</b>
13		Bieleta estabilizadora trasera Rear stabiliser rod Biellette de stabilisateur arrière Biela estabilizadora traseira	← →	Todos los modelos	<b>24529</b> <b>01.02312.0</b>	5178.38
14		Juego reparación suspensión Suspension repair unit Jeu de réparation de suspension Conjunto de reparação da suspensão	← →	Todos los modelos -->  Chassis N°: O 07664	<b>24930</b>	3640 35
15		Casquillo guía Guide bushing Bague de guidage Casquilho da guia	← → ↑		<b>22505</b>	5131 99
16		Casquillo guía Guide bushing Bague de guidage Casquilho da guia	← → ↓		<b>22506</b>	5131 80
17		Soporte de goma (Silentblock) Rubber mounting Support en caoutchouc Suporte goma (Sino-bloco)	← →	Ch N° 07665  -->	<b>22500</b>	3640 41
18		Soporte de goma (Silentblock) Rubber mounting Support en caoutchouc Suporte goma (Sino-bloco)			<b>22504</b>	5131 78



## RÓTULAS, BRAZOS DE SUSPENSIÓN Y BIELETAS

ROTULES, BRAS DE SUSPENSION ET BIELLETES

TIE ROD ENDS, SUSPENSION ARMS AND CONNECTING RODS

05/2004 | -->

SUSPENSION, DIRECCION Y TRANSMISION / SUSPENSION, TRANSMISSION ET DIRECTION / SUSPENSION, TRANSMISSION AND STEERING

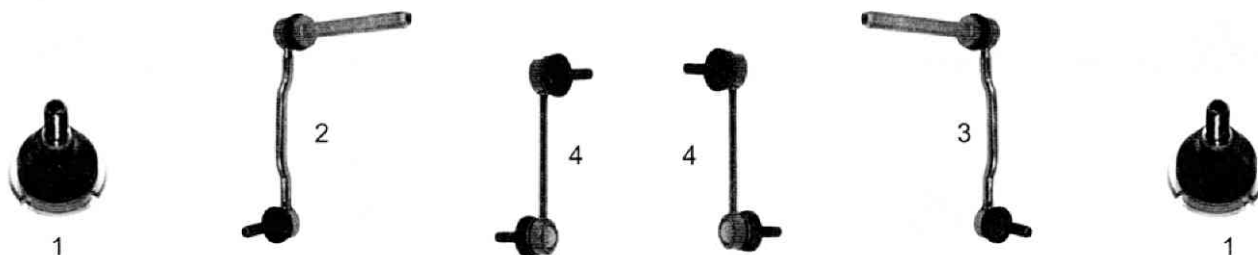

					REF. O.E.	
1		Rótula suspensión inferior Lower suspension ball joint Rotule de suspension inférieure Rótula da suspensão inferior		← → ↓ Excepto 1.8 16V, 2.0 16V y 2.2 16V	<b>28335</b>	3640 57
2		Bieleta estabilizadora Stabiliser rod Biellette de stabilisateur Biela estabilizadora		← Excepto 1.8 16V, 2.0 16V y 2.2 16V	<b>29574</b>	5087.52
3		Bieleta estabilizadora Stabiliser rod Biellette de stabilisateur Biela estabilizadora		→ Excepto 1.8 16V, 2.0 16V y 2.2 16V	<b>29575</b>	5087.53
4		Bieleta estabilizadora trasera Rear stabiliser rod Biellette de stabilisateur arrière Biela estabilizadora traseira		← → Excepto 1.8 16V, 2.0 16V y 2.2 16V	<b>29576</b>	5178.46

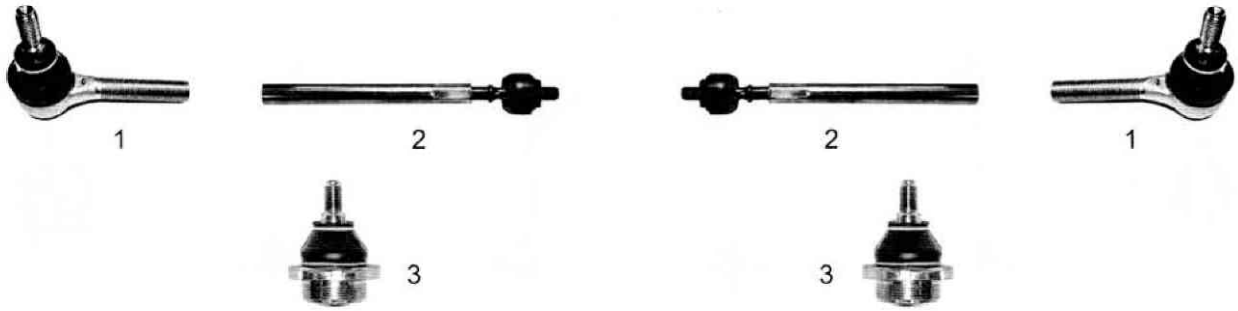
**RÓTULAS, BRAZOS DE SUSPENSIÓN Y BIELETAS**
**ROTULES, BRAS DE SUSPENSION ET BIELLETES**
**TIE ROD ENDS, SUSPENSION ARMS AND CONNECTING RODS**
**1980 |-->**

					REF. O.E.
1	Rótula dirección Steering ball joint Rotule de direction Rótula de direcção	←	→		<b>12070</b> 3817.10 01.00924.1
2	Rótula axial Axial ball joint Rotule axiale Rótula axial	←	→		<b>12444</b> - 01.00036.1
3	Rótula suspensión inferior Lower suspension ball joint Rotule de suspension inférieure Rótula da suspensão inferior	←	→	1982  --> ↓	<b>12062</b> 3640.15 01.03019.0

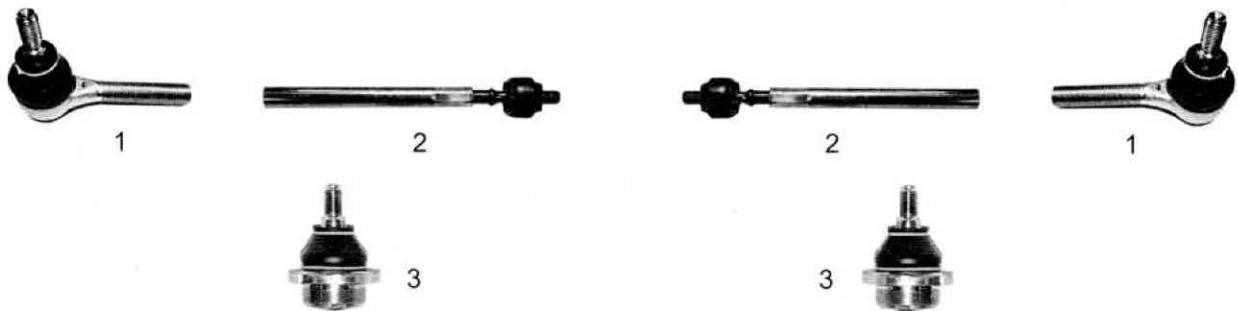
**PEUGEOT 505 / 604**
**05/1979 - 12/1993**

					REF. O.E.
1	Rótula dirección Steering ball joint Rotule de direction Rótula de direcção	←	→	Excepto 1.6 4x4 y 2.0 79kw	<b>12070</b> 3817.10 01.00924.1 <span style="float: right;">12067</span>
2	Rótula axial Axial ball joint Rotule axiale Rótula axial	←	→	Excepto 1.6 4x4 y 2.0 79kw	<b>12282</b> - 01.00931.1 <span style="float: right;">12067</span>
3	Rótula suspensión inferior Lower suspension ball joint Rotule de suspension inférieure Rótula da suspensão inferior	←	→	Excepto 1.6 4x4 y 2.0 79kw ↓	<b>12062</b> 3640.15 01.03019.0

**RÓTULAS, BRAZOS DE SUSPENSIÓN Y BIELETAS**

*ROTULES, BRAS DE SUSPENSION ET BIELLETES*

TIE ROD ENDS, SUSPENSION ARMS AND CONNECTING RODS

6B

06/1989 - 09/1999

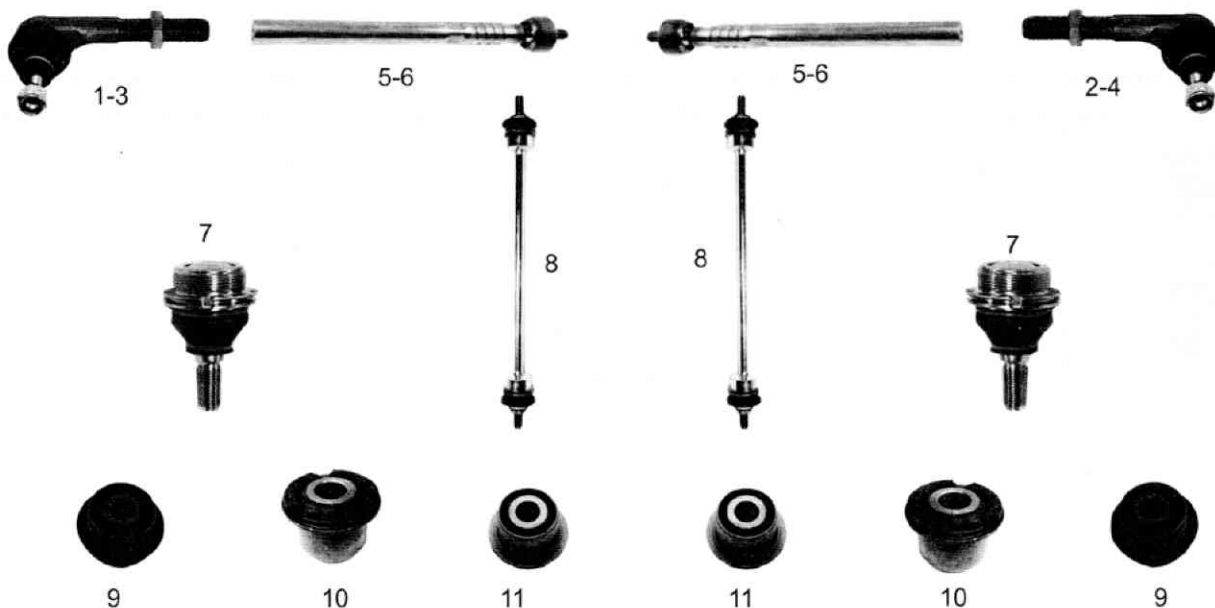









					REF. O.E.
1		Rótula dirección Steering ball joint Rotule de direction Rótula de direcção	←	Excepto 2.1D y 2.0 79kw para vehículos con dirección asistida L-110mm Ø16mm M16x1,5mm	<b>26750</b> 3817.43 01.02204.0
2		Rótula dirección Steering ball joint Rotule de direction Rótula de direcção	→	Excepto 2.1D y 2.0 79kw para vehículos con dirección asistida L-110mm Ø16mm M16x1,5mm	<b>26751</b> 3817.44 01.02205.0
3		Rótula dirección Steering ball joint Rotule de direction Rótula de direcção	→	Excepto 2.1 D y 2.0 79kw L-114mm Ø14,6mm M14x1,5mm	<b>14799</b> 3817.30 01.03124.1
4		Rótula dirección Steering ball joint Rotule de direction Rótula de direcção	←	Excepto 2.1 D y 2.0 79kw L-114mm Ø14,6mm M14x1,5mm	<b>14800</b> 3817.31 01.03125.1
5		Rótula axial Axial ball joint Rotule axiale Rótula axial	← →	Excepto 2.1 D y 2.0 79kw, L2- 295mm 12x1mm/14x1,5mm Para REF: 26750/26751	<b>14791</b> 3812.99 01.50803.0
6		Rótula axial Axial ball joint Rotule axiale Rótula axial	← →	Excepto 2.1 D y 2.0 79kw L2- 293mm M12x1mm/16x1,5mm Para REF: 14799/14800	<b>25488</b> 3812.A6 01.02206.0
7		Rótula suspensión inferior Lower suspension ball joint Rotule de suspension inférieure Rótula da suspensão inferior	← → ↓	Excepto 2.1 D y 2.0 79kw	<b>11592</b> 95 028 039 01.50516.0
8		Bieleta estabilizadora delantera Front stabiliser rod Biellette de stabilisateur avant Biela estabilizadora dianteira	← →	Excepto 2.1 D y 2.0 79kw	<b>11580</b> 5087.41 01.50514.0

SUSPENSION, DIRECCION Y TRANSMISION / SUSPENSION, TRANSMISSION ET DIRECTION / SUSPENSION, TRANSMISSION AND STEERING

**RÓTULAS, BRAZOS DE SUSPENSIÓN Y BIELETAS**
*ROTULES, BRAS DE SUSPENSION ET BIELLETES*

TIE ROD ENDS, SUSPENSION ARMS AND CONNECTING RODS

**06/1989 - 09/1999**
**6B**

9		Silent-block brazo suspensión Silent-block arm support Silentbloc du bras de suspension Sino-bloco do braço da suspensão		<b>29376</b>	3523 43
					<b>REF. O.E.</b>
10		Soporte de goma (Silentblock) Rubber mounting Support en caoutchouc Suporte goma (Sino-bloco)		<b>22502</b>	5131.55
11		Soporte de goma (Silentblock) Rubber mounting Support en caoutchouc Suporte goma (Sino-bloco)		<b>22499</b>	3332.07

## RÓTULAS, BRAZOS DE SUSPENSIÓN Y BIELETAS





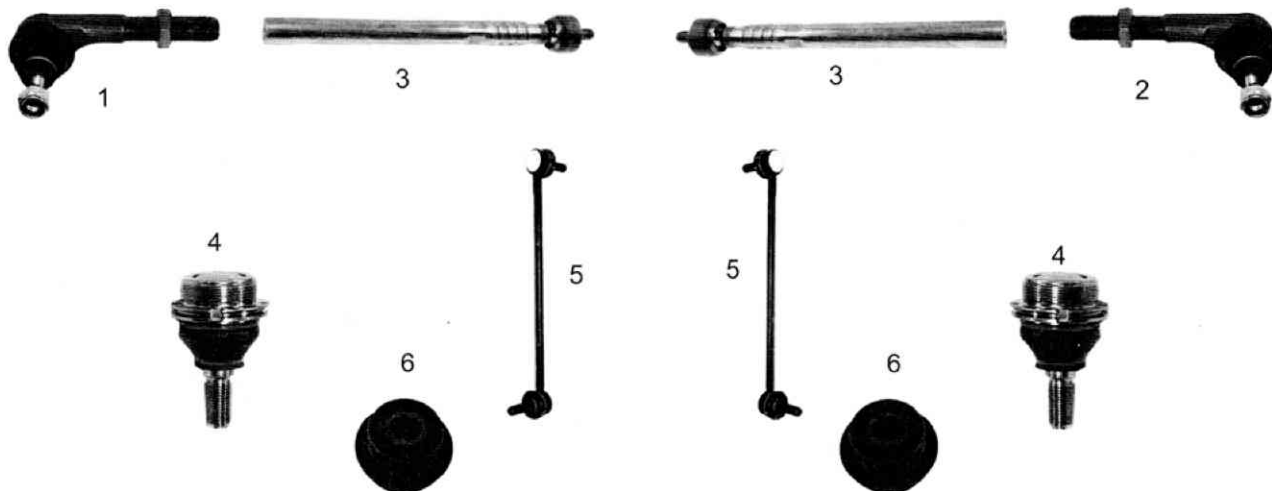

ROTULES, BRAS DE SUSPENSION ET BIELLETES

TIE ROD ENDS, SUSPENSION ARMS AND CONNECTING RODS

9\_

02/2000 |-->











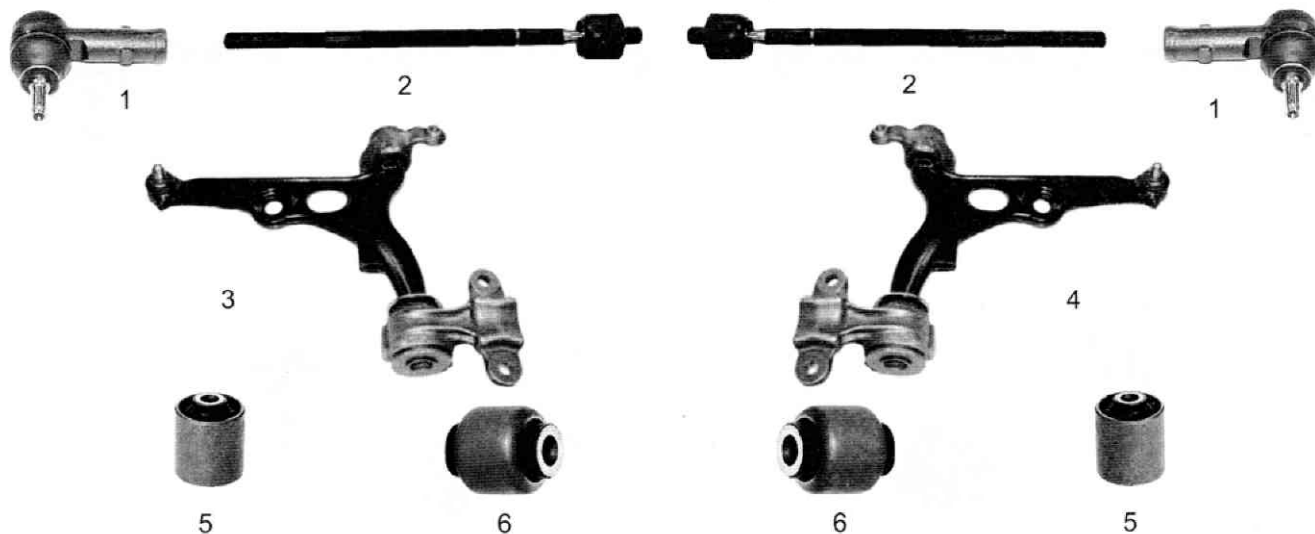



					REF. O.E.
	Rótula dirección Steering ball joint Rotule de direction Rótula de direcção	←	Mod. 3.0 V6 24V y 2.2 HDI. Para vehículos con dirección asistida L-110mm Ø16mm M16x1,5mm	26750 01.02204.0	3817.43
	Rótula dirección Steering ball joint Rotule de direction Rótula de direcção	→	Mod. 3.0 V6 24V y 2.2 HDI. Para vehículos con dirección asistida L-110mm Ø16mm M16x1,5mm	26751 01.02205.0	3817.44
	Rótula axial Axial ball joint Rotule axiale Rótula axial	← →	L2-300mm M16x1,5/16x1,5mm	01.02578.0	3812.C7
	Rótula suspensión inferior Lower suspension ball joint Rotule de suspension inférieure Rótula da suspensão inferior	← → ↓	Excepto 2.2 16V 120kw 2.0 HDI 100kw y 2.7HDI 24V Ø17,5mm	11592 01.50516.0	3640.34
	Bieleta estabilizadora delantera Front stabiliser rod Bielle de stabilisateur avant Biela estabilizadora dianteira	← →	Excepto 2.2 16V 120kw 2.0 HDI 100kw y 2.7HDI 24V L-320mm M12mm	22724 01.02200.0	5087.48
	Silent-block brazo suspensión Silent-block arm support Silentbloc du bras de suspension Sino-bloco do braço da suspensão	← → ↓		29376	3523.43

**RÓTULAS, BRAZOS DE SUSPENSIÓN Y BIELETAS**
**ROTULES, BRAS DE SUSPENSION ET BIELLETES**
**TIE ROD ENDS, SUSPENSION ARMS AND CONNECTING RODS**

06/1994 |--&gt;

221

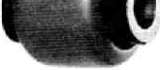

					REF. O.E.
		Rótula dirección Steering ball joint Rotule de direction Rótula de direcção	← →	Excepción 2.0 HDI 16V y 1.8 i L-74mm Ø14,4mm M14x1,5mm Rosca D	<b>19251</b> 4059.09 04.03655.1
		Rótula axial Axial ball joint Rotule axiale Rótula axial	← →	Excepción 2.0 HDI 16V y 1.8 i L2-350mm M14x1,5/14x1,5mm	<b>27702</b> 3812.A4 04.03656.1
		Brazo suspensión inferior Lower suspension arm Bras de suspension inférieur Braço da suspensão inferior	← ↓	Excepción 2.0 HDI 16V y 1.8 i 06/1994 - 07/2002	<b>27065</b> 3520.C3 02.05245.0
		Brazo suspensión inferior Lower suspension arm Bras de suspension inférieur Braço da suspensão inferior	→ ↓	Excepción 2.0 HDI 16V y 1.8 i 06/1994 - 07/2002	<b>27066</b> 3521.83 02.05244.0
		Soporte de goma (Silentblock) Rubber mounting Support en caoutchouc Suporte goma (Sino-bloco)	← →	Excepción 2.0 HDI 16V	<b>26578</b> 5152.61
		Soporte de goma (Silentblock) Rubber mounting Support en caoutchouc Suporte goma (Sino-bloco)	← →	Excepción 2.0 HDI 16V	<b>26592</b> 14 60 649 080

**RÓTULAS, BRAZOS DE SUSPENSIÓN Y BIELETAS**

*ROTULES, BRAS DE SUSPENSION ET BIELLETES*

TIE ROD ENDS, SUSPENSION ARMS AND CONNECTING RODS

E

06/2002 |-->



1









2



2









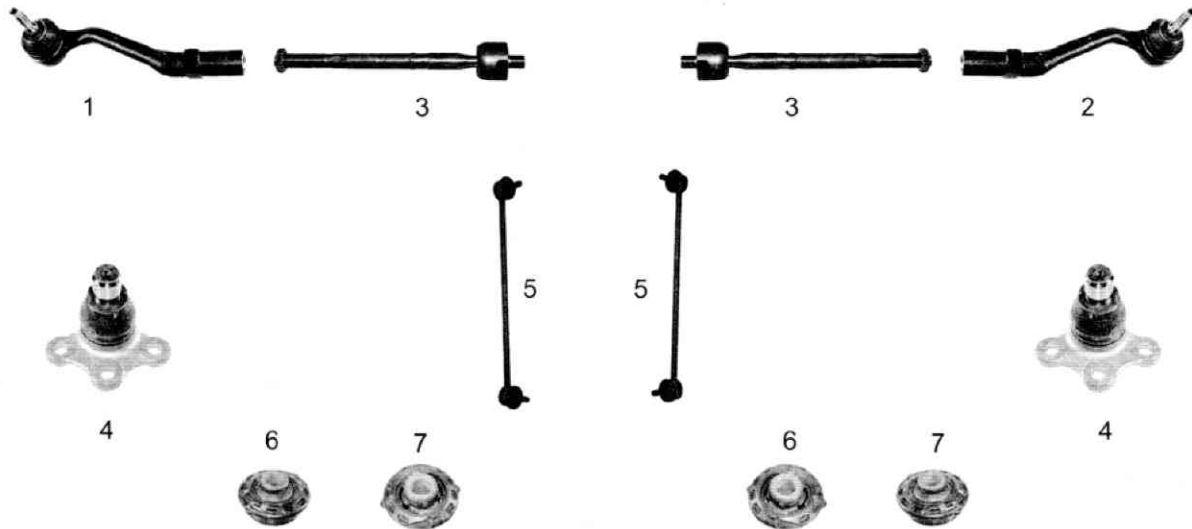

1

					REF. O.E.
1	 <p>Rótula dirección Steering ball joint Rotule de direction Rótula de direcção</p>	  <p>← → Excepto 2.0 16V</p>		<p><b>28324</b> 4059.12 04.99827.0</p>	
2	 <p>Bieleta estabilizadora delantera Front stabiliser rod Biellette de stabilisateur avant Biela estabilizadora dianteira</p>	  <p>← → Excepto 2.0 16V</p>		<p><b>27080</b> 5087 51</p>	

**RÓTULAS, BRAZOS DE SUSPENSIÓN Y BIELETAS**
**ROTULES, BRAS DE SUSPENSION ET BIELLETES**
**TIE ROD ENDS, SUSPENSION ARMS AND CONNECTING RODS**

04/2005 |--&gt;



					REF. O.E.
1	 Rótula dirección Steering ball joint Rotule de direction Rótula de direcção	←			<b>25505</b> 3817.55 01.02582.0
2	 Rótula dirección Steering ball joint Rotule de direction Rótula de direcção		→		<b>25506</b> 3817.56 01.02583.0
3	 Rótula axial Axial ball joint Rotule axiale Rótula axial	←	→		<b>25507</b> 3812.E1 01.02584.0
4	 Rótula suspensión inferior Lower suspension ball joint Rotule de suspension inférieure Rótula da suspensão inferior	←	→	↓	<b>30453</b> 3640 59
5	 Bieleta estabilizadora delantera Front stabiliser rod Bielle de stabilisateur avant Biela estabilizadora dianteira	←	→		<b>22651</b> 5087.45 01.02309.0
6	 Silent-block brazo suspensión Silent-block arm support Silentbloc du bras de suspension Sino-bloco do braço da suspensão	←	→	↓	<b>29529</b> 3523 98
7	 Silent-block brazo suspensión Silent-block arm support Silentbloc du bras de suspension Sino-bloco do braço da suspensão	←	→	↓	<b>29530</b> 3523 AA



## RÓTULAS, BRAZOS DE SUSPENSIÓN Y BIELETAS

ROTULES, BRAS DE SUSPENSION ET BIELLETES

TIE ROD ENDS, SUSPENSION ARMS AND CONNECTING RODS

03/1994 - 04/2002

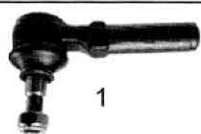

1



2



2

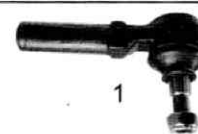

1



3-4











5-7



6-8



3-4

					REF. O.E.
	1 Rótula dirección Steering ball joint Rotule de direction Rótula de direcção	← →	Excepto 2.0	<b>24534</b> 04.03793.1	4018.A3
	2 Rótula axial Axial ball joint Rotule axiale Rótula axial	← →	Excepto 2.0	<b>25108</b> 04.03794.1	4018.A4
	3 Rótula suspensión inferior Lower suspension ball joint Rotule de suspension inférieure Rótula da suspensão inferior	← → ↓	Excepto 2.0 Ø19mm 1.000 - 1.400 Kg	<b>24538</b> 04.99759.0	3640.32
	4 Rótula suspensión inferior Lower suspension ball joint Rotule de suspension inférieure Rótula da suspensão inferior	← → ↓	Excepto 2.0 Ø22mm 1.800 Kg  -->	<b>24539</b> 04.99760.0	3640.33
	5 Brazo suspensión inferior Lower suspension arm Bras de suspension inférieur Braço da suspensão inferior	← ↓	1.000 - 1.400 Kg	<b>28153</b> 02.05265.0	3520.95
	6 Brazo suspensión inferior Lower suspension arm Bras de suspension inférieur Braço da suspensão inferior	→ ↓	1.000 - 1.400 Kg	<b>28152</b> 02.05264.0	3521.65
	7 Brazo suspensión inferior Lower suspension arm Bras de suspension inférieur Braço da suspensão inferior	← ↓	1.800 Kg  -->	<b>28155</b> 02.05267.0	3520.96
	8 Brazo suspensión inferior Lower suspension arm Bras de suspension inférieur Braço da suspensão inferior	→ ↓	1.800 Kg  -->	<b>28154</b> 02.05266.0	3521.66

**RÓTULAS, BRAZOS DE SUSPENSIÓN Y BIELETAS**
**ROTULES, BRAS DE SUSPENSION ET BIELLETES**
**TIE ROD ENDS, SUSPENSION ARMS AND CONNECTING RODS**

04/2002 |--&gt;

244/Z\_

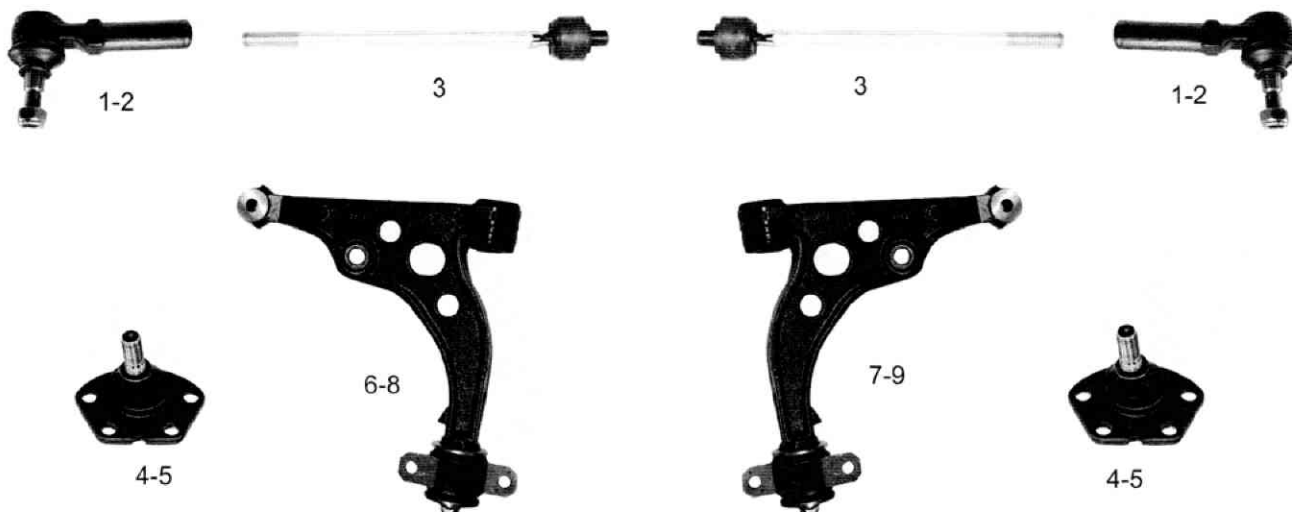

					REF. O.E.
1		Rótula dirección Steering ball joint Rotule de direction Rótula de direção	← →	12/2002 -->	<b>24534</b> 4018 A3/H4 04.03793.1
2		Rótula dirección Steering ball joint Rotule de direction Rótula de direção	← →	12/2002  -->	<b>28499</b> 4018.E0 04.99829.0
3		Rótula axial Axial ball joint Rotule axiale Rótula axial	← →		<b>25108</b> 4018 A4/400624 04.03794.1
4		Rótula suspensión inferior Lower suspension ball joint Rotule de suspension inférieure Rótula da suspensão inferior	← → ↓	1.100 y 1.500 kg Ø16mm	<b>26667</b> -
5		Rótula suspensión inferior Lower suspension ball joint Rotule de suspension inférieure Rótula da suspensão inferior	← → ↓	1.800 Kg Ø18,9mm	<b>26668</b> -
6		Brazo suspensión inferior Lower suspension arm Bras de suspension inférieure Braço da suspensão inferior	← ↓	Ø19 1.100 y 1.500 kg Chs.: 16194399 -->  usa esta rot susp. 24538 Chs: 16494400  --> sin restricciones	<b>29417</b> 3520 L0/N3
7		Brazo suspensión inferior Lower suspension arm Bras de suspension inférieure Braço da suspensão inferior	→ ↓	Ø19 1.100 y 1.500 kg Chs.: 16194399 -->  usa esta rot susp. 24538 Chs: 16494400  --> sin restricciones	<b>29418</b> 3521 H2/J3
8		Brazo suspensión inferior Lower suspension arm Bras de suspension inférieure Braço da suspensão inferior	← ↓	Ø22 1.800 kg Ch: 16194399 -->  usa esta rot susp. 24539 Chs: 16494400  --> sin restricciones	<b>29419</b> 3520 L1/N4
9		Brazo suspensión inferior Lower suspension arm Bras de suspension inférieure Braço da suspensão inferior	→ ↓	Ø22 1.800 kg Chs. 16194399 -->  usa esta rot susp. 24539 Chs: 16494400  --> sin restricciones	<b>29420</b> 3521 H3/J4

## RÓTULAS, BRAZOS DE SUSPENSIÓN Y BIELETAS

ROTULES, BRAS DE SUSPENSION ET BIELLETES

TIE ROD ENDS, SUSPENSION ARMS AND CONNECTING RODS

280L/280P/290L/290P

09/1981 - 03/1994

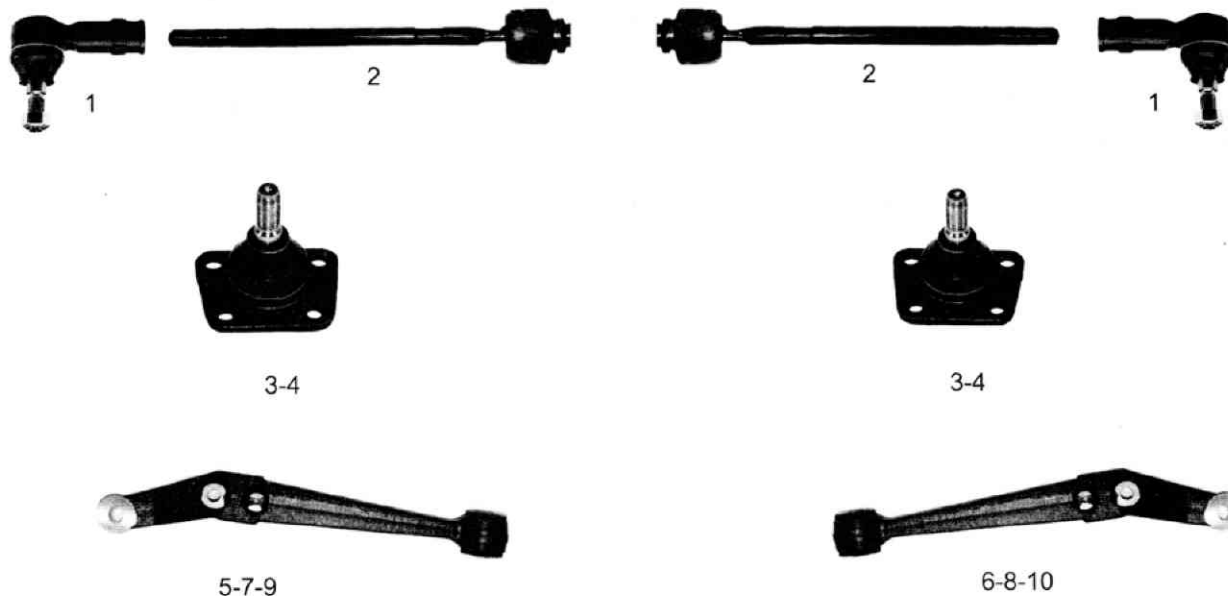





					REF. O.E.
1		Rótula dirección Steering ball joint Rotule de direction Rótula de direcção	← →		<b>11603</b> 4 336 779 04.99758.0
2		Rótula axial Axial ball joint Rotule axiale Rótula axial	← →		<b>15377</b> 9750001180 04.99757.0
3		Rótula suspensión inferior Lower suspension ball joint Rotule de suspension inférieure Rótula da suspensão inferior	← → ↓	Ø18,4mm -->  09/1985	<b>14773</b> 4 288 159 04.99756.0
4		Rótula suspensión inferior Lower suspension ball joint Rotule de suspension inférieure Rótula da suspensão inferior	← → ↓	Ø19,5mm 10/1985  -->	<b>11591</b> 7567284 04.99755.0
5		Brazo suspensión inferior Lower suspension arm Bras de suspension inférieur Braço da suspensão inferior	← ↓	1981 - 10/1985	<b>28092</b> 43 918 14 02.05197.0
6		Brazo suspensión inferior Lower suspension arm Bras de suspension inférieur Braço da suspensão inferior	→ ↓	1981 - 10/1985	<b>28100</b> 43 918 13 02.05196.0
7		Brazo suspensión inferior Lower suspension arm Bras de suspension inférieur Braço da suspensão inferior	← ↓	10/1985 - 1994	<b>22786</b> 75 767 32 02.05217.0
8		Brazo suspensión inferior Lower suspension arm Bras de suspension inférieur Braço da suspensão inferior	→ ↓	10/1985 - 03/1994	<b>22785</b> 75 767 31 02.05218.0







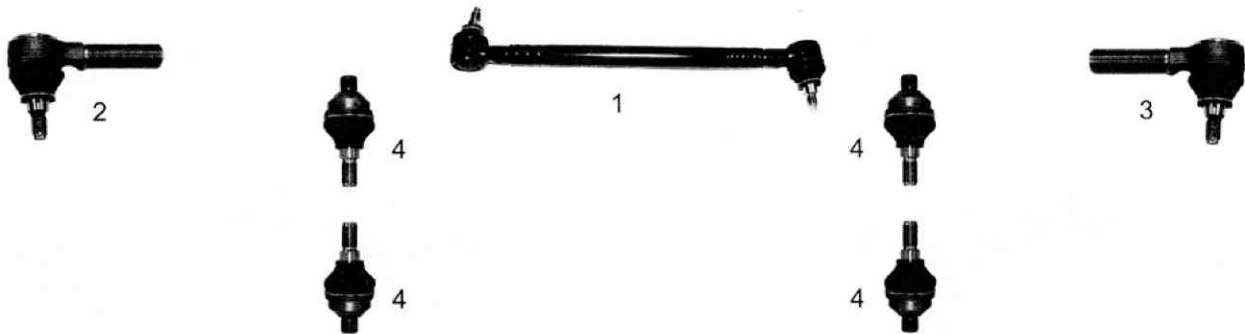

**RÓTULAS, BRAZOS DE SUSPENSIÓN Y BIELETAS**
*ROTULES, BRAS DE SUSPENSION ET BIELLETES*

## TIE ROD ENDS, SUSPENSION ARMS AND CONNECTING RODS

**09/1981 - 03/1994**
**280L/280P/290L/290P**

9	 Brazo suspensión inferior Lower suspension arm Bras de suspension inférieur Braço da suspensão inferior	 1.8 Tn	<b>28171</b>	7 567 283
			02.05341.0	
10	 Brazo suspensión inferior Lower suspension arm Bras de suspension inférieur Braço da suspensão inferior	 1.8 Tn	<b>28158</b>	7 567 282
			02.05340.0	

**08/1968 - 06/1987**

				REF. O.E.
1	 Barra dirección Centre tie rod assembly Barre de direction Barra de direcção		<b>17516</b>	3813.30
			04.99712.0	
2	 Rótula dirección Steering ball joint Rotule de direction Rótula de direcção		<b>19358</b>	3874.31
			04.99713.0	
3	 Rótula dirección Steering ball joint Rotule de direction Rótula de direcção		<b>17513</b>	3874.30
			04.99714.0	
4	 Rótula suspensión superior-inferior Upper-Lower suspension ball joint Rotule de suspension supérieur-inférieure Rótula da suspensão superior-inferior		<b>11639</b>	3608.28
			04.27008.0	

## RÓTULAS, BRAZOS DE SUSPENSIÓN Y BIELETAS

ROTULES, BRAS DE SUSPENSION ET BIELLETES

TIE ROD ENDS, SUSPENSION ARMS AND CONNECTING RODS

06/1996 |-->

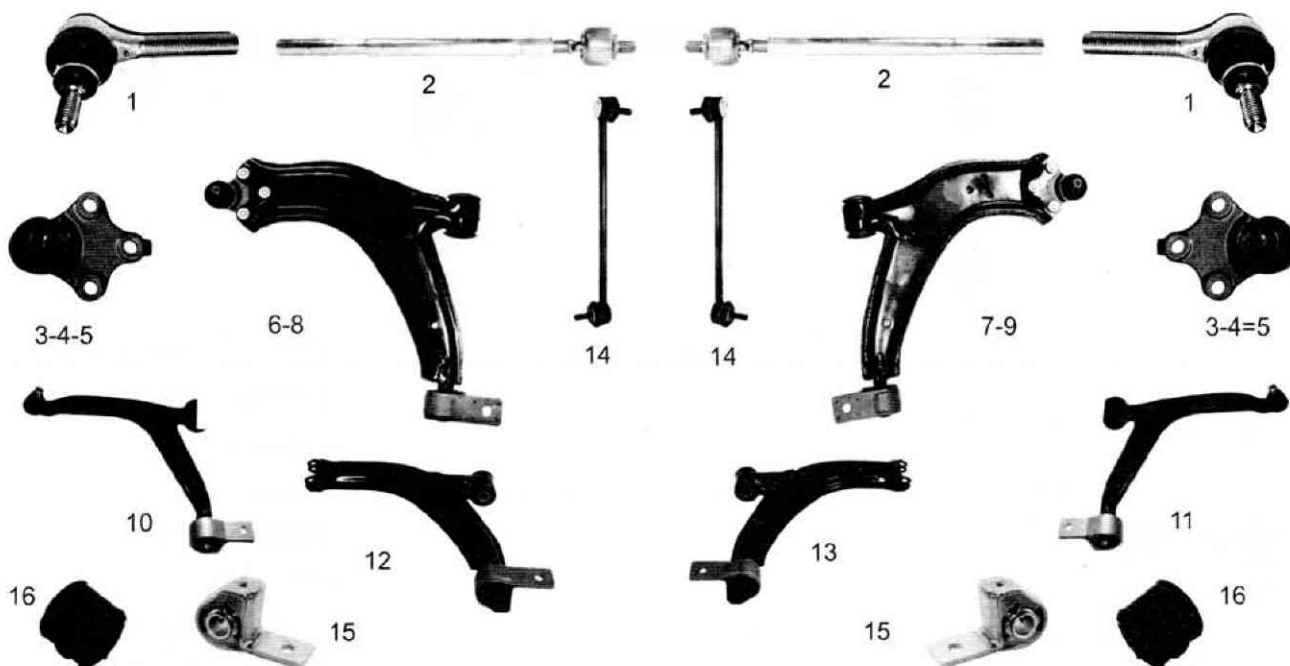









					REF. O.E.
1		Rótula dirección Steering ball joint Rotule de direction Rótula de direcção	← → ↓	Excepto 1.9D 4x4, 1.9D 1868ccm y 2.0 HDi 4x4	<b>12070</b> 3817.10 <b>01.00924.1</b>
2		Rótula axial Axial ball joint Rotule axiale Rótula axial	← →	Todos los modelos	<b>14792</b> 3812.C0 <b>01.50504.0</b>
3		Rótula suspensión inferior Lower suspension ball joint Rotule de suspension inférieure Rótula da suspensão inferior	← → ↓	Ch Nº 07972 -->  Ø16mm	<b>14767</b> 3640.43 <b>01.50500.0</b> 17436 17435
4		Rótula suspensión inferior Lower suspension ball joint Rotule de suspension inférieure Rótula da suspensão inferior	← → ↓	Ø18mm Dir. Asistida Ch Nº 7973  -->	<b>25534</b> 3640.51 <b>01.02202.0</b> 28125 28126
5		Rótula suspensión inferior Lower suspension ball joint Rotule de suspension inférieure Rótula da suspensão inferior	← → ↓	Ø18mm Dir. Mecanica Ch Nº 7973  -->	<b>26047</b> 3640 50
6		Brazo suspensión inferior Lower suspension arm Bras de suspension inférieure Braço da suspensão inferior	← → ↓	Sin dirección asistida: 14767 Ch Nº 07972 -->  26047 Ch Nº 07973  --> Con dirección asistida: 14767 Ch Nº 07972 -->  25534 Ch Nº 07973	<b>17435</b> 3521.H8/H6/H5 <b>02.05121.0</b> 14767 27711
7		Brazo suspensión inferior Lower suspension arm Bras de suspension inférieure Braço da suspensão inferior	→ ↓	Sin dirección asistida: 14767 Ch Nº 07972 -->  26047 Ch Nº 07973  --> Con dirección asistida: 14767 Ch Nº 07972 -->  25534 Ch Nº 07973	<b>17436</b> 3521.E8/E6/E5 <b>02.05120.0</b> 14767 27712
8		Brazo suspensión inferior Lower suspension arm Bras de suspension inférieure Braço da suspensão inferior	← ↓		<b>28125</b> - <b>02.05390.0</b> 25534 27711

**RÓTULAS, BRAZOS DE SUSPENSIÓN Y BIELETAS**
*ROTULES, BRAS DE SUSPENSION ET BIELLETES*

## TIE ROD ENDS, SUSPENSION ARMS AND CONNECTING RODS

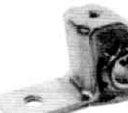
06/1996 |--&gt;

9		Brazo suspensión inferior Lower suspension arm Bras de suspension inférieur Braço da suspensão inferior	→ ↓		<b>28126</b> 02.05391.0	- 25534 27712
10		Brazo suspensión inferior Lower suspension arm Bras de suspension inférieur Braço da suspensão inferior	← ↓	Mod. 2.0 HDi Ch N° 08365  -->	<b>26714</b> 02.05541.0	3520.J3
11		Brazo suspensión inferior Lower suspension arm Bras de suspension inférieur Braço da suspensão inferior	→ ↓	Mod. 2.0 HDi Ch N° 08365  -->	<b>26715</b> 02.05540.0	3521.F3
12		Brazo suspensión inferior (sin rótula) Lower suspension arm (NO ball joint) Bras de suspension inférieur (Sans Rotule) Braço da suspensão inferior (NO rótula)	← ↓		<b>27711</b> 02.05568.0	3520.H3 17435 28125
13		Brazo suspensión inferior (sin rótula) Lower suspension arm (NO ball joint) Bras de suspension inférieur (Sans Rotule) Braço da suspensão inferior (NO rótula)	→ ↓		<b>27712</b> 02.05569.0	3521.E3 17436 28126
14		Bieleta estabilizadora delantera Front stabiliser rod Bielle de stabilisateur avant Biela estabilizadora dianteira	← →	Excepto 1.9D 4x4, 1.9D 1868ccm y 2.0 HDi 4x4	<b>11589</b> 01.02203.0	5087.46
15		Silent-block brazo suspensión Silent-block arm support Silentbloc du bras de suspension Sino-bloco do braço da suspensão	← → ↓		<b>27924</b>	3523.75
16		Silent-block barra estabilizadora Rubber mounting Support en caoutchouc Suporte goma (Sino-bloco) estabilizador	← →	Ø21mm	<b>26577</b>	5094.65

## RÓTULAS, BRAZOS DE SUSPENSIÓN Y BIELETAS

## ROTULES, BRAS DE SUSPENSION ET BIELLETES

## TIE ROD ENDS, SUSPENSION ARMS AND CONNECTING RODS

/ L.I.I. / REF. O.E. / PAG

Reference N°

N° Reference

Cruzamento das referências

L.I.I.	REF. O.E.	L.I.I.	REF. O.E.	L.I.I.	REF. O.E.
<b>CITROËN</b>					
11580	01.50514.0	5087.41/49	15334	01.50501.0	96 093 233
11582	01.03056.1	95 495 439	15377	04.99757.0	9750001180
11582	01.03056.1	95 495 440	15613	01.00053.0	91 504 248
11582	01.03056.1	95 495 440/439	15613	01.00053.0	91 504 248
11583	01.03055.1	95 496 044	15613	01.00053.0	91 504 248
11584	01.03054.1	95 496 045	17408	01.00061.0	3520.34
11585	01.50740.0	95494821	17408	01.00061.0	91 504 354
11586	01.03020.0	3640.21	17408	01.00061.0	91 504 354
11588	01.03498.1	5087.32	17408	01.00061.0	91 504 358
11589	01.02203.0	5087.39	17409	01.00060.0	3521.23
11589	01.02203.0	5087.39/42/46	17409	01.00060.0	91 504 355
11589	01.02203.0	5087.39/42/46	17409	01.00060.0	91 504 355
11589	01.02203.0	5087.42	17409	01.00060.0	91 504 359
11589	01.02203.0	5087.46	17433	02.05119.0	3520.78
11589	01.02203.0	5087.46	17433	02.05119.0	95 658 978
11589	01.02203.0	5087.46	17434	02.05118.0	3520.79
11591	04.99755.0	7567284	17434	02.05118.0	95 658 979
11592	01.50516.0	3640.28/34	17435	02.05121.0	3520.H5
11592	01.50516.0	3640.34	17435	02.05121.0	3520.H6
11592	01.50516.0	3640.34	17435	02.05121.0	3520.H8
11596	01.03053.0	95 603 309	17435	02.05121.0	3520.H8/H6/H5
11600	01.50506.0	96 111 480	17435	02.05121.0	3520.H8/H6/H5
11601	01.02201.0	96 145 457	17435	02.05121.0	3520.H8/H6/H5
11603	04.99758.0	4 336 779	17436	02.05120.0	3521.E5
11658	01.03041.1	-	17436	02.05120.0	3521.E6
11658	01.03041.1	3812.95	17436	02.05120.0	3521.E6/E5
12064	01.03043.0	91 516 336	17436	02.05120.0	3521.E8
12064	01.03043.0	91 516 336	17436	02.05120.0	3521.E8/E6/E5
12065	01.03042.0	91 516 337	17436	02.05120.0	3521.E8/E6/E5
12065	01.03042.0	91 516 337	17451		3523.52
12070	01.00924.1	3817.10	17452		3523.51
12070	01.00924.1	3817.10	17452		96 106 474
12070	01.00924.1	3817.10	17464	01.03518.1	5087.40
12070	01.00924.1	3817.10	17464	01.03518.1	5087.40
12070	01.00924.1	3817.10	19251	04.03655.1	4059.09
12070	01.00924.1	3817.10/50	19251	04.03655.1	4059.09
12070	01.00924.1	3817.50	19257		5131 70
12070	01.00924.1	3817.50	19257		5131 70
12070	01.00924.1	3817.50	19257		5131 70
12070	01.00924.1	3817.50	19304	01.00101.1	96 136 394
12070	01.00924.1	95 493 208	19306	01.02616.0	96 147 514
12282	01.00931.1	-	19307		5131.69
12282	01.00931.1	-	19307		5131.69
14767	01.50500.0	3640.39/42/43	19307		5131.69
14767	01.50500.0	3640.39/42/43	19307		5131.69
14767	01.50500.0	3640.39/42/43	22327	01.02207.0	3817.33
14773	04.99756.0	3640.18	22509		5131 63
14791	01.50803.0	3812.99	22509		5131 63
14792	01.50504.0	3812.00	22513		-
14792	01.50504.0	3812.00	22651	01.02309.0	5087.45
14792	01.50504.0	3812.C6	22724	01.02200.0	5087.43
14792	01.50504.0	96048007581	22724	01.02200.0	5087.43/48
14793	02.05117.0	95614999	22724	01.02200.0	5087.48
14793	02.05117.0	96 133 608	22724	01.02200.0	5087.48
14794	02.05116.0	95615000	22785	02.05218.0	75 767 31
14794	02.05116.0	96 133 609	22786	02.05217.0	75 767 32
14799	01.03124.1	3817.14/30/41	22786	02.05217.0	7695191
14799	01.03124.1	3817.41	24512		3523.50
14799	01.03124.1	3817.41	24515		96 148 480
14799	01.03124.1	3817.41	24515		96 148 480
14799	01.03124.1	3817.41	24534	04.03793.1	130 671 60 80
14800	01.03125.1	3817.16/31/42	24534	04.03793.1	4018.A3
14800	01.03125.1	3817.42	24538	04.99759.0	130 236 80 80
14800	01.03125.1	3817.42	24539	04.99760.0	130 047 30 80
14800	01.03125.1	3817.42	25108	04.03794.1	400624
14800	01.03125.1	3817.42	25108	04.03794.1	4018 A4/400624
14800	01.03125.1	3817.42	25108	04.03794.1	9945836
14800	01.03125.1	3817.42	25256		3817 47
15334	01.50501.0	3640.36/96 093 233	25488	01.02206.0	3812.A6
			25488	01.02206.0	3812.A6
			25505	01.02582.0	3817.55
			25505	01.02582.0	3817.55
			25506	01.02583.0	3817.56
			25506	01.02583.0	3817.56
			25507	01.02584.0	3812.E1
			25507	01.02584.0	3812.E1
			25508	01.02586.0	3817.53
			25509	01.02587.0	3817.54
			25534	01.02202.0	3640.51
			25534	01.02202.0	3640.51
			25534	01.02202.0	3640.51
			26047		3640 50
			26047		3640 50
			26047		3640 50
			26059	01.02576.0	3812.E0
			26571		5094.66
			26575		95 638 690
			26577		5094.65
			26578		5152.61
			26592		14 60 649 080
			26653		5087.50
			26667		3640 55
			26668		3640 54
			26714	02.05541.0	3520 J3
			26714	02.05541.0	3520 J3
			26715	02.05540.0	3521.E3
			26715	02.05540.0	3521.F3
			26729	02.05124.0	352 181
			26729	02.05124.0	352 182
			26729	02.05124.0	3521.58
			26729	02.05124.0	3521.59/82/81
			26729	02.05124.0	3521.81
			26729	02.05124.0	3521.82
			26730	02.05125.0	3520.86
			26730	02.05125.0	3520.C1
			26730	02.05125.0	3520.C1/C2
			26730	02.05125.0	3520.C2
			26735	02.05213.0	3520.93
			26735	02.05213.0	3520.93
			26736	02.05214.0	3520.92
			26736	02.05214.0	3520.92
			26750	01.02204.0	3817.37
			26750	01.02204.0	3817.43
			26750	01.02204.0	3817.43
			26750	01.02204.0	3817.43/37
			26751	01.02205.0	3817.38
			26751	01.02205.0	3817.44
			26751	01.02205.0	3817.44
			26751	01.02205.0	3817.44
			26751	01.02205.0	3817.44/38
			27065	02.05245.0	3520.G3
			27065	02.05245.0	3520.G3
			27065	02.05245.0	3520.P4
			27066	02.05244.0	3521.83
			27066	02.05244.0	3521.83
			27066	02.05244.0	3521.K4
			27080		5087.51
			27299	01.02577.0	3640.60
			27702	04.03656.1	3812.A4
			27702	04.03656.1	3812.A4
			27711	02.05568.0	-
			27711	02.05568.0	-
			27711	02.05568.0	3520.H3
			27712	02.05569.0	-
			27712	02.05569.0	3521.E3
			27924		3523.75
			27979	01.02209.0	3812.A0
			27979	01.02209.0	3812.A0/95609129
			27979	01.02209.0	3812.A0/95609129
			27979	01.02209.0	95609129
			27980	01.02197.0	96 091 568
			27981	01.02208.0	3817.36
			27982	01.02300.0	3817.35
			27983	01.02301.0	3817.32
			28076	02.05098.0	91 519 409
			28077	02.05099.0	91 519 408
			28092	02.05197.0	35204

**RÓTULAS, BRAZOS DE SUSPENSIÓN Y BIELETAS**
**ROTULES, BRAS DE SUSPENSION ET BIELLETES**
**TIE ROD ENDS, SUSPENSION ARMS AND CONNECTING RODS**

 Reference N°  
 N° Référence  
 Cruzamento das referencias

/ L.I.I. / REF. O.E. / PAG

	L.I.I.	REF. O.E.
28092	02.05197.0	43 918 14
28100	02.05196.0	43 918 13
28125	02.05390.0	-
28125	02.05390.0	-
28125	02.05390.0	-
28126	02.05391.0	-
28126	02.05391.0	-
28126	02.05391.0	-
28152	02.05264.0	130 860 10 80
28152	02.05264.0	1317241080
28152	02.05264.0	3521.65
28153	02.05265.0	130 860 00 80
28153	02.05265.0	1317240080
28153	02.05265.0	3520.95
28154	02.05266.0	130 876 00 80
28154	02.05266.0	1317239080
28154	02.05266.0	3521.66
28155	02.05267.0	130 875 90 80
28155	02.05267.0	1317238080
28155	02.05267.0	3520.96
28158	02.05340.0	3521.53
28158	02.05340.0	7 567 282
28158	02.05340.0	7695185
28171	02.05341.0	352 077
28171	02.05341.0	7 567 283
28171	02.05341.0	7695186
28324	04.99827.0	4059.12
28324	04.99827.0	4059.12
28499	04.99829.0	4018.E0
28896		3523.95
28897		3523.84
28898		3523 91
28899		3523 92
28965		3520 L4
28966		3521 H6
28971		3640 52
29376		3523 43
29417		3520 L0/N3
29418		3521 H2/J3
29419		3520 L1/N4
29420		3521 H3/J4
29529		3523 98
29529		3523 98
29530		3523 AA
29530		3523 AA
29596		3520 L9
29597		3521 J1
30451		3640.56
30452		3640 61
30453		3640 59
30453		3640 59
30606		3520 P3
30607		3521 K3
01.02192.0		-
01.02588.0		3812.C8
01.02641.0		3817.34
02.05628.0		-
02.05628.0		-
02.05628.0		-
02.05629.0		-
02.05629.0		-
02.05629.0		-

	L.I.I.	REF. O.E.
<b>PEUGEOT</b>		
11580	01.50514.0	5087.41
11586	01.03020.0	3640.21
11586	01.03020.0	3640.21
11586	01.03020.0	96 041 652
11588	01.03498.1	5087.23
11588	01.03498.1	5087 23/32
11588	01.03498.1	5087.32
11589	01.02203.0	5087.46
11589	01.02203.0	5087.46
11590		5131 71
11591	04.99755.0	7567284
11592	01.50516.0	3640.34
11592	01.50516.0	3640.34
11592	01.50516.0	3640.34
11592	01.50516.0	95 028 039
11603	04.99758.0	4 336 779
11639	04.27008.0	3608.28
11658	01.03041.1	3812.25
11658	01.03041.1	3812.25
11658	01.03041.1	3812.25
11658	01.03041.1	3812.95
12062	01.03019.0	3640.15
12064	01.03043.0	3520.51
12065	01.03042.0	3521.34
12066	01.50800.0	3521.26
12070	01.00924.1	3817.10
12070	01.00924.1	3817.10
12070	01.00924.1	3817.10
12070	01.00924.1	3817.10
12070	01.00924.1	3817.10
12070	01.00924.1	3817.10
12070	01.00924.1	3817.10/18
12070	01.00924.1	3817.50
12073	01.03045.1	3817.21/26
12073	01.03045.1	3817.21/26
12074	01.03044.1	3817.22/27
12074	01.03044.1	3817.22/27
12282	01.00931.1	-
12282	01.00931.1	-
12282	01.00931.1	79100300
12444	01.00036.1	-
14766		3 52 349
14767	01.50500.0	3640.43
14773	04.99756.0	4 288 159
14791	01.50803.0	3812.99
14792	01.50504.0	3812.C0
14798		3523 40
14799	01.03124.1	3817.30
14799	01.03124.1	3817.41
14799	01.03124.1	3817.41
14799	01.03124.1	3817.41
14799	01.03124.1	3817.41/30
14799	01.03124.1	3817.41/30
14800	01.03125.1	3817.31
14800	01.03125.1	3817.42
14800	01.03125.1	3817.42
14800	01.03125.1	3817.42
14800	01.03125.1	3817.42/31

	L.I.I.	REF. O.E.
14800	01.03125.1	3817.42/31
14977	01.50901.0	3640.30/37
14978	01.50900.0	3640.31/44
15334	01.50501.0	3640.36
15334	01.50501.0	3640.36
15377	04.99757.0	9750001180
15613	01.00053.0	-
17408	01.00061.0	3520.34
17409	01.00060.0	3521.23
17433	02.05119.0	3520.78
17434	02.05118.0	3520.79
17435	02.05121.0	3521.H8/H6/H5
17436	02.05120.0	3521.E5
17436	02.05120.0	3521.E6
17436	02.05120.0	3521.E8
17436	02.05120.0	3521.E8/E6/E5
17451		3523.52
17451		3523.52
17452		3523.51
17464	01.03518.1	5087.40
17464	01.03518.1	5087.40
17501	01.50801.0	3520.37
17502	01.03072.0	3520.57/60
17511	01.03071.0	3521.41/38
17513	04.99714.0	3874.30
17515	01.50802.0	3812.92
17516	04.99712.0	3813.30
18208	01.00854.1	7702 103 636
19247		3523 20
19249	01.03046.1	3812.98
19251	04.03655.1	4059.09
19256	01.02310.0	5087.39
19256	01.02310.0	5087.39/42/46
19256	01.02310.0	5087.42
19256	01.02310.0	5087.46
19257		5131 70



## RÓTULAS, BRAZOS DE SUSPENSIÓN Y BIELETAS

ROTULES, BRAS DE SUSPENSION ET BIELLETES



TIE ROD ENDS, SUSPENSION ARMS AND CONNECTING RODS

Reference N°

N° Référence

Cruzamento das referências

 / L.I.I. / REF. O.E. / PAG

	L.I.I.	REF. O.E.	PAG		L.I.I.	REF. O.E.	PAG		L.I.I.	REF. O.E.	PAG
<b>PEUGEOT</b>											
11580	01.50514.0		5087.41	631							
11586	01.03020.0		3640.21	618							
11586	01.03020.0		3640.21	625							
11586	01.03020.0	96 041	652	617							
11588	01.03498.1		5087.23	624							
11588	01.03498.1		5087.23/32	613							
11588	01.03498.1		5087.32	612							
11589	01.02203.0		5087.46	619							
11589	01.02203.0		5087.46	642							
11590			5131 71	619							
11591	04.99755.0		7567284	639							
11592	01.50516.0		3640.34	625							
11592	01.50516.0		3640.34	627							
11592	01.50516.0		3640.34	633							
11592	01.50516.0	95 028	039	631							
11603	04.99758.0		4 336 779	639							
11639	04.27008.0		3608.28	641							
11658	01.03041.1		3812.25	612							
11658	01.03041.1		3812.25	613							
11658	01.03041.1		3812.25	616							
11658	01.03041.1		3812.95	617							
12062	01.03019.0		3640.15	630							
12064	01.03043.0		3520.51	612							



Adaptable to Citroën- Peugeot not original parts

**RÓTULAS, BRAZOS DE SUSPENSIÓN Y BIELETAS**

*ROTULES, BRAS DE SUSPENSION ET BIELLETES*

**TIE ROD ENDS, SUSPENSION ARMS AND CONNECTING RODS**

SUSPENSIÓN, DIRECCIÓN Y TRANSMISIÓN / SUSPENSION, TRANSMISSION ET DIRECTION / SUSPENSION, TRANSMISSION AND STEERING

**▲ / L.I.I. / REF. O.E. / PAG**

Reference N°  
N° Référence  
Cruzamento das referências

▲	L.I.I.	REF. O.E.	▲	L.I.I.	REF. O.E.	▲	L.I.I.	REF. O.E.
19304	01.00101.1	3812.09	26736	02.05214.0	3520.80	29530		3523 AA
19304	01.00101.1	3812.09	26736	02.05214.0	3520.92	29574		5087.52
19306	01.02616.0	5087.33	26737	02.05215.0	3520.C0	29575		5087.53
19306	01.02616.0	5087.33	26738	02.05216.0	3521.80	29576		5178.46
19307		5131.69	26750	01.02204.0	3817.43	30452		3640 61
19358	04.99713.0	3874.31	26750	01.02204.0	3817.43	30453		3640 59
22327	01.02207.0	3817.33	26751	01.02205.0	3817.44	30602		3817 67
22327	01.02207.0	3817.33	26751	01.02205.0	3817.44	30603		3817 68
22346	01.03792.1	3812.C4	26881	01.02080.0	3640.49	30604		3812 E8
22498		3523 31	27050	02.05219.0	3520.47	30606		3520 S2 / K8
22499		3332.07	27051	02.05220.0	3521.76	30607		3521 P3 / G8
22500		3640 41	27065	02.05245.0	3520.C3	30667		5087 54
22502		5131.55	27066	02.05244.0	3521.83	30668		5087 55
22504		5131 78	27080		5087 51		01.02578.0	3812.C7
22505		5131 99	27299	01.02577.0	3640.53		01.03070.1	3812.97
22506		5131 80	27702	04.03656.1	3812.A4		02.05178.0	3521.44
22509		5131 63	27711	02.05568.0	-		02.05178.0	3521.44
22509		5131 63	27711	02.05568.0	3520.H3		02.05179.0	3520.63
22651	01.02309.0	5087.45	27712	02.05569.0	-		02.05179.0	3520.63
22651	01.02309.0	5087.45	27712	02.05569.0	3521.E3			
22724	01.02200.0	5087.43/48	27924		3523.75			
22724	01.02200.0	5087.48	27979	01.02209.0	3812.A0			
22724	01.02200.0	5087.48	27979	01.02209.0	3812.A0			
22785	02.05218.0	75 767 31	27981	01.02208.0	3817.36			
22786	02.05217.0	75 767 32	27982	01.02300.0	3817.35			
24512		3523.50	27983	01.02301.0	3817.32			
24515		96 148 480	27984	01.02302.0	3817.34			
24515		96 148 480	27984	01.02302.0	3817.34			
24529	01.02312.0	5178.38	28076	02.05098.0	3521.37			
24534	04.03793.1	4018 A3/H4	28077	02.05099.0	3520.54			
24534	04.03793.1	4018.A3	28078	02.05101.0	3520.83			
24538	04.99759.0	3640.32	28092	02.05197.0	43 918 14			
24539	04.99760.0	3640.33	28100	02.05196.0	43 918 13			
24722	01.03790.1	3817.39	28125	02.05390.0	-			
24723	01.03791.1	3817.40	28126	02.05391.0	-			
24726	01.02558.0	5178.39/96 287 831	28135	02.05511.0	-			
24930		3640 35	28136	02.05512.0	-			
25108	04.03794.1	4018 A4/400624	28140	02.05104.0	3521.45			
25108	04.03794.1	4018.A4	28150	02.05105.0	3520.64			
25177	02.05492.0	3520.G8	28152	02.05264.0	130 860 10 80			
25178	02.05493.0	3521.C8	28152	02.05264.0	1317241080			
25256		3817 47	28152	02.05264.0	1320787080			
25256		3817 47	28152	02.05264.0	3521.65			
25488	01.02206.0	3812.A6	28153	02.05265.0	130 860 00 80			
25493		3812.A9	28153	02.05265.0	1317240080			
25502	01.02306.0	3812.C5	28153	02.05265.0	1320786080			
25505	01.02582.0	3817.55	28153	02.05265.0	3520.95			
25506	01.02583.0	3817.56	28154	02.05266.0	130 876 00 80			
25507	01.02584.0	3812.E1	28154	02.05266.0	1317239080			
25508	01.02586.0	3817 59	28154	02.05266.0	3521.66			
25509	01.02587.0	3817 60	28155	02.05267.0	130 875 90 80			
25534	01.02202.0	3640.51	28155	02.05267.0	1317238080			
25999		5094 63	28155	02.05267.0	3520.96			
26047		3640 50	28158	02.05340.0	7 567 282			
26059	01.02576.0	3812.E0	28171	02.05341.0	7 567 283			
26563		5094 64	28324	04.99827.0	4059.12			
26577		5094.65	28335		3640 57			
26577		5094.65	28499	04.99829.0	4018.E0			
26578		5152.61	28746	02.05566.0	-			
26592		14 60 649 080	28747	02.05567.0	-			
26653		5087.50	28898		3523 91			
26667		-	28899		3523 92			
26668		-	28899		3523 92			
26714	02.05541.0	3520.J3	29374		3523 78			
26715	02.05540.0	3521.F3	29375		3523 61			
26722	01.02554.0	3640.48	29376		3523 43			
26724	02.05094.0	3521.46/49	29376		3523 43			
26725	02.05095.0	3520.65/68	29377		3523 76			
26726	02.05100.0	3521.55	29417		3520 L0/N3			
26727	02.05102.0	3521.56	29418		3521 H2/J3			
26728	02.05103.0	3520.84	29419		3520 L1/N4			
26735	02.05213.0	3520.81	29420		3521 H3/J4			
26735	02.05213.0	3520.93	29529		3523 98			

**RÓTULAS, BRAZOS DE SUSPENSIÓN Y BIELETAS***ROTULES, BRAS DE SUSPENSION ET BIELLETES*

TIE ROD ENDS, SUSPENSION ARMS AND CONNECTING RODS

Reference N°

N° Référence

Cruzamento das referências

 / L.I.I. / REF. O.E. / PAG

	L.I.I.	REF. O.E.	PAG
29530		3523 AA	636
29574		5087.52	629
29575		5087.53	629
29576		5178.46	629
30452		3640 61	615
30453		3640 59	636
30602		3817 67	615
30603		3817 68	615
30604		3812 E8	615
30606		3520 S2 / K8	622
30607		3521 P3 / G8	622
30667		5087 54	615
30668		5087 55	615
	01.02578.0	3812.C7	633
	01.03070.1	3812.97	624
	02.05178.0	3521.44	617
	02.05178.0	3521.44	618
	02.05179.0	3520.63	617
	02.05179.0	3520.63	618