

# RECAMBIOS ELECTRICOS DEL AUTOMOVIL

## APPAREILLAGES ELECTRIQUES POUR L'AUTOMOBILE

### AUTO-ELECTRICAL MANUFACTURES



# FAE

MATERIAL ELECTRICO / MATERIEL ELECTRIQUE / ELECTRIC PARTS



### SIMBOLOS Y LEYENDA / SYMBOLES ET LEGENDE / SYMBOLS AND EXPLANATION

	<b>Manocontactos presión de aceite</b> <i>Manocontacts pression d'huile</i> Oil pressure switches		<b>Transmisores presión aceite y aire</b> <i>Transmetteurs pression d'huile et d'air</i> Oil and air pressure transmitters		<b>Manocontactos neumáticos</b> <i>Manocontacts pneumatiques</i> Pneumatic switches
	<b>Interruptores luz de stop</b> <i>Contacteurs de feu stop</i> Stop light switches		<b>Termo-resistencias</b> <i>Thermistances</i> Temperature sending units		<b>Sensores</b> <i>Senseurs</i> Sensors
	<b>Sensor aire</b> <i>Senseur d'air</i> Air sensor		<b>Termo-resistencia-termocontacto</b> <i>Thermistance - thermocontact</i> Thermistor - thermocontact		<b>Termocontactos temperatura</b> <i>Thermocontacts température</i> Bimetallic temperature contacts
	<b>Termocontactos ventilador</b> <i>Thermocontacts pour ventilateur</i> Bimetallic temperature contacts for fan		<b>Termoc. para 2 ventiladores o 2 veloc.</b> <i>Therm. pour 2 ventilateurs ou à 2 vitesses</i> Thermo-switches for 2 fans or 2 speeds		<b>Interruptores de luz marcha atrás</b> <i>Contacteurs de phare de recul</i> Reversing light switches
	<b>Luces de control y portalámparas</b> <i>Lampes témoin et douilles</i> Indicator lamps and bulb holders		<b>Conmutadores, interrup., pulsadores</b> <i>Commutateurs, interrupteurs, poussoirs</i> Panel switches, press buttons		<b>Interruptores puerta y alarma</b> <i>Contacteur de porte et avertisseur</i> Door and alarm switches
$^{\circ}\text{C}$ $^{\circ}\text{F}=(^{\circ}\text{C}\times 1,8)+32$	<b>Temperaturas nominales de trabajo</b> <i>Températures nominales de travail</i> Nominal working temperature range	<b>CABLE</b> <b>mm.</b>	<b>Longitud del cable en mm.</b> <i>Longueur du câble en mm.</i> Wire length in mm.	<b>12V.</b> <b>24V.</b>	<b>Tensión de trabajo</b> <i>Tension de travail</i> Working voltage

**ACCESORIOS ELECTRICOS**

ACCESOIRES ELECTRIQUES / ELECTRIC ACCESSORIES



**SIMBOLOS Y LEYENDA / SYMBOLES ET LEGENDE / SYMBOLS AND EXPLANATION**

**FIJACION Y ROSCA / FIXATION ET FILET / THREAD AND LODGE**

	<b>Cilíndrica</b> Cylindrique Cylindrical		<b>Cónica</b> Conique Conical		<b>Diámetro</b> Diamètre Diameter
	<b>Alojamiento</b> Logement Lodge		<b>Fijación y conector</b> Fixation et connecteur Thread and connector		<b>Interior</b> Intérieur Interior

**TERMINALES / BORNES / TERMINALS**



**CONECTORES / CONNECTEURS / CONNECTORS**

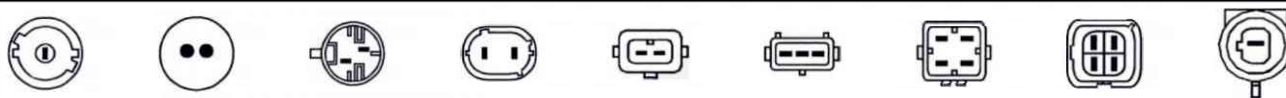

**INTERRUPTORES TABLEROS / INTERRUPTEURS TABLEAU / PANEL SWITCHES**



ESQUEMA ELECTRICO / SCHEMA ELECTRIQUE / ELECTRICAL SCHEME

		<b>Normalmente cerrado</b> Normalement fermé Normally closed			<b>Normalmente abierto</b> Normalement ouvert Normally open
		<b>Resistencia variable</b> Résistance variable Variable resistance	<b>Dos funciones</b> Deux fonctions Two functions		
				<b>Termocontactos temperatura y ventilador</b> Thermocontacts température et ventilateur Bimetallic temperature contacts and thermo - switches for fan	

**CIRCUITOS COMBINADOS / CIRCUITS COMBINES / COMBINED CIRCUITS**

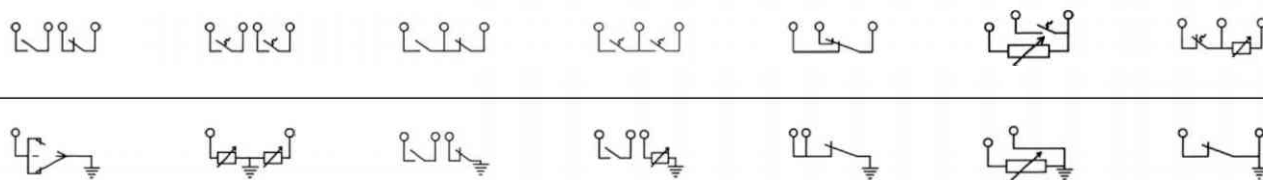

**INTERRUPTORES TABLEROS / INTERRUPTEURS TABLEAU / PANEL SWITCHES**

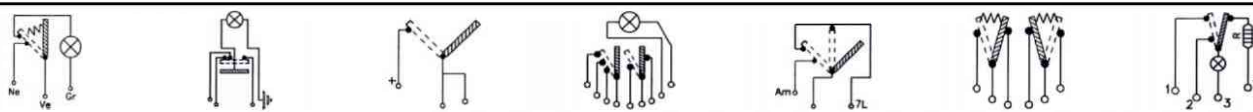

..... No disponible ..... Non disponible ..... Not available

MATERIA ELECTRICO / MATERIEL ELECTRIQUE / ELECTRIC PARTS

CONEXION / CONNEXION / CONNECTION

ACCESORIOS ELÉCTRICOS

ACCESSOIRES ELECTRIQUES / ELECTRIC ACCESSORIES



**MANOCONTACTOS Y TRANSMISORES PRESION DE ACEITE  
OIL PRESSURE SWITCHES AND TRANSMITTERS  
MANOCONTACTS ET TRANSMETTEURS PRESSION D'HUILE**



**MANOCONTACTOS PRESION DE ACEITE  
OIL PRESSURE SWITCHES  
MANOCONTACTS PRESSION D'HUILE**



**TRANSMISORES PRESION ACEITE Y AIRE  
TRANSMITTERS PRESSURE SWITCHES  
TRANSMETTEURS PRESSION D'HUILE**



**MANOCONTACTOS NEUMÁTICOS  
PNEUMATIC SWITCHES  
MANOCONTACTS PNEUMATIQUES**



**ACCESORIOS ELÉCTRICOS**  
ACCESOIRES ELECTRIQUES / ELECTRIC ACCESSORIES



MANOCONTACTOS PRESION DE ACEITE  
OIL PRESSURE SWITCHES  
MANOCONTACTS PRESSION D'HUILE

**10020**

SIMCA



10x1 PRESION 0,25÷0,50

**10160**

CITROEN  
DS. ID 1955-56

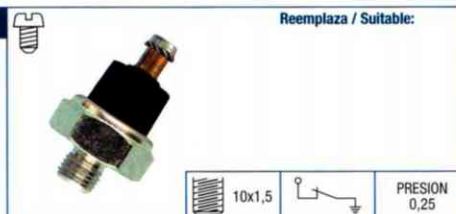

Reemplaza / Suitable:

10x1,5 PRESION 0,25

**10200**

CITROEN	TALBOT-SIMCA
2 CV 4, 6, 3 CV. Acadiane	Aronde 1965-66
Ami 6, 8, Break, Super	Simca 1951-59
Dyane 4, 6	
Mehari 0.6	
LN. LNA. 2 cil.	



Reemplaza / Suitable:

BMW	12 611 277 591
Citroen	5.460.577
	5.508.282
Mercedes	005 542 9017

12x1,5 PRESION 0,50

**10230**

CITROEN  
2 CV. 3 CV. --> 1965  
Ami 6, Break --> 1967



Reemplaza / Suitable:

12x1,75 PRESION 0,25

**10250**

CITROEN  
HY Van. HZ Van  
2 CV. 3 CV  
Ami 6  
DS. ID



Reemplaza / Suitable:

Mercedes 004 542 5917

14x1,5 PRESION 0,25÷0,50

**11250**

CITROEN  
C 25 E 1.8, 2.0 1985-93  
CX 25 Diesel 1985-89  
CX 2.5 DI Turbo, Turbo II 1985-89



Reemplaza / Suitable:

Citroën	91.521.112
	95.494.103
	95.556.508

14x1,5 PRESION 0,50

**11260**

PEUGEOT  
J 5 2.5 Diesel, 2.5 TD 1981-93  
CITROEN  
CX 25 Diesel 1980-85



Reemplaza / Suitable:

Citroën 95.493.861

Peugeot 1131.12

14x1,5 PRESION 0,60

**IMPORTANTE:**

Al pedir accesorios eléctricos, rogamos completen la referencia comenzando por 'F' (ejemplo: 381394 → F381394)  
Pour commander accessoires électriques, nous vous prions de compléter la référence en commençant par 'F'.  
When ordering electric accessories, please complete the reference by beginning with 'F'.



## ACCESORIOS ELÉCTRICOS

## ACCESSOIRES ELECTRIQUES / ELECTRIC ACCESSORIES



**MANOCONTACTOS PRESION DE ACEITE  
OIL PRESSURE SWITCHES  
MANOCONTACTS PRESSION D'HUILE**

### 11410

**PEUGEOT**  
505 GTI, TI, STI 1979-88

6,35 mm



**Reemplaza / Suitable:**  
Peugeot 1131.09

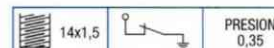

### 11430

**TALBOT - SIMCA**  
Ariane 1957-66  
Aronde 1956-65  
Simca 900 (E) 1961-68  
Simca 1000 1963-74  
Simca 1100 1967-72  
Simca 1200 GL, GLE. (E) 1969-74  
Simca 1200 S (E) 1973-74  
Simca 1300, 1301, 1301 S 1963-70  
Simca 1500, 1501, 1501 S 1964-70

6,35 mm



**Reemplaza / Suitable:**  
Bosch 0344 101 061  
Talbot 22179T  
SA-78173060

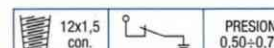

### 11620

**PEUGEOT**  
505 GTI, STI, Injection 1988-91

6,35 mm



**Reemplaza / Suitable:**  
Peugeot 1131.54



### 11630

PEUGEOT	PEUGEOT COMM.
205 1.0, 1.2, 1.3, 1.4. (TU) 1987-93	J 9 Diesel 1986-93
205 1.2 i, 1.4 i. (TU) 1989-94	
309 1.1, 1.1i, 1.3, 1.3i.(TU) 1990-93	
405 1.4 GL, GR. (TU) 1987-93	
604 Diesel, Turbo D 1984-87	

6,35 mm



**Reemplaza / Suitable:**  
Ford 1646357  
86 GB 9278 AB  
Peugeot 1131.45



### 11650

CITROËN	PEUGEOT	TALBOT - SIMCA
2 CV 4, 6, Special 1974-90	205 XA, XRA, 1118-1294 1988-93	Horizon 1.1, 1.3, 1.6 4 veloc. 1978-86
C 15 E 1118-1294 cc. 1987-88	205 GL, GR, GT, SR. (E) 1987-88	Simca 1200 (E) 1981-83
Dyane 6 AYB -> 1982	205 1.3 SR, XR. (E) 1985-94	Solara LS, GLS. 4 veloc. 1980-84
	205 1.6 GTX (E) 1987-89	Solara Diesel 1980-84
	309 1.1, 1.3 1986-93	150 LS, GLS. 4 veloc. 1981-86
	309 1.5 GR, SX. (E) 1987-93	180, 2 l 1972-81

6,35 mm



**Reemplaza / Suitable:**  
Citroën 95.521.111  
Peugeot 1131.44

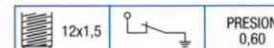

Ver/See Ref. FAE 12160.

### 12150

**PEUGEOT**  
205 GTX 1592 cc. (F) 1987-89  
205 GTX (E) 1989-94  
309 1.6 SR (E) 1987-93  
505 Turbo 1987-91

6,35 mm



**Reemplaza / Suitable:**  
Peugeot 1131.41

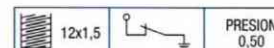

Vehículos con transmisor de aceite.  
Cars with oil pressure transmitter.  
Voitures avec transmetteurs d'huile.

### 12160

PEUGEOT	TALBOT - SIMCA Cont.	TALBOT (GB)
205 GL, GR, GT, SR. (E) 1984-87	Simca 900, 1000, 1100 1967-76	Alpine 1.3, 1.5, 1.6 SX 1975-84
205 GTX (E) 1986-87	Simca 1200 (E) 1974-81	Horizon 1.1, 1.3, 1.5 1978-86
205 XL, XR. (E) 1984-87	Simca 1300, 1301, S 1970-75	Minx, Rapier 1.6 1984-86
505 Turbo 1979-86	Simca 1307, 1308, 1309 1975-86	Rancho 1.5 1978-84
	Simca 1500, 1501, 1510 1970-86	Solara 1.3, 1.6, SX 1980-84
	Solara LS, GLS. 2156 cc. 1980-84	Tagora 2.2 GL, GLS 1981-84
<b>TALBOT-SIMCA</b>	Tagora GL, GLS. 2156 cc. 1981-84	180, 2 l 1972-81
Horizon 1.1, 1.3 1978-86	150, 160, 1609, 1610 1970-81	
Matra Bagheera. 530 LX 1973-80	180, 2 l 1972-81	
Matra Rancho. Murena 1977-84		

4 mm



**Reemplaza / Suitable:**  
Peugeot 1131.19  
Rover Group GPS 119  
Talbot 0055442300  
SL-78173030

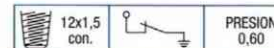

Ver/See Ref. FAE 11650.

### IMPORTANTE:

Al pedir accesorios eléctricos, rogamos completen la referencia comenzando por 'F' (ejemplo: 381394 → F381394)

Pour commander accessoires électriques, nous vous prions de compléter la référence en commençant par 'F'.

When ordering electric accessories, please complete the reference by beginning with 'F'.

## ACCESORIOS ELÉCTRICOS

### ACCESSOIRES ELECTRIQUES / ELECTRIC ACCESSORIES



**MANOCONTACTOS PRESION DE ACEITE**  
**OIL PRESSURE SWITCHES**  
**MANOCONTACTS PRESSION D'HUILE**

#### 12170

CITROEN		PEUGEOT		TALBOT - SIMCA	
Axel	1984-90	309 SR (E)	1986-93	Horizon GLS 1.5, 1.6	1978-86
Dyane 6 AYB	1974-82			Matra Bagheera (Y2, Y4)	1979-80
GS	1972-81			Simca 1000, 1000 Rallye	1976-78
GSA	1980-86			Simca 1100 (F)	1976-81
				Simca 1307, 1308, 1309	1978-86
				Simca 1510 5 veloc.	1979-86
				Solara GLS, SX, 5 veloc.	1980-84
				Solara Escorial 1.6	1985-87
				150 GT, SX, S, 5 veloc.	1977-86



**Reemplaza / Suitable:**  
**Citroën** 75.460.576  
 75.474.985  
 95.495.376  
 GX-0147702-A  
 GX-0147703-A  
**Peugeot** 1131.25  
**Talbot** 0016573000

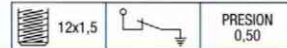

#### 12250

CITROEN		CITROEN Cont.	
C 25 Diesel, Turbo D	1981-93	CX 25 IE, GTI, TRI, RI	1983-85
CX 2000 1985 cc.	1974-85	CX 2.5 Turbo, Turbo 2	1984-89
CX 2000 2175 cc.	1974-76	CX 25 Diesel	1978-79
CX 2.0 RE, TRE, X	1981-89	CX 2.5 DI Turbo, Turbo 2	1983-89
CX 2200 Diesel	1976-79		
CX 2400 Pallas	1976-89		
CX 2400 Prestige	1976-83		
CX 2400 GTI, Injection	1977-84		



**Reemplaza / Suitable:**  
**Citroën** 75.490.801  
 75.413.615  
 95.495.159



#### 12260

CITROEN		TALBOT	
BX, BX 14, 1360 cc.	1983-86	Samba GL, LS, S	1981-86
C 15 E 1124-1360 cc.	1984-87	Tagora SX 2664 cc.	1982-84
C 25 E 1.8, 2.0	1981-89		
LNA 11 E, RE, RS	1982-86		
Visa	1978-89		



**Reemplaza / Suitable:**  
**Citroën** 91.511.279  
 95.591.148  
**Peugeot** 113104, 113148  
**Renault** 91 51 127 980  
 91 51 443 280

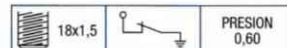

#### 12270

PEUGEOT		PEUGEOT Cont.		TALBOT	
204 Diesel	1974-77	505 GLD, GRD, SRD	1979-86	Tagora Turbo Diesel	1982-84
304 Diesel	1969-80	505 Turbo Diesel 2.5	1983-86		
305 Diesel 1.6, 1.9	1979-83	604 Diesel, Turbo Diesel	1978-84		
504 Diesel	1968-82	<b>PEUGEOT COMM.</b>			
		304 Van Diesel	1976-81		
		J 7 Diesel	1968-89		
		J 9 Diesel	1979-86		



**Reemplaza / Suitable:**  
**Peugeot** 1131.05  
 1131.10  
**Renault** 77 00 694 210  
 77 00 715 965  
**Talbot** 9350087780

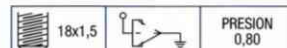

#### 12280

CITROEN	
2 CV 6, Special, 3 CV	1970-90
Ami 6, Ami 8, C-8	1967-80
Ami Super 1015 cc.	1973-76
Dyane AYA	1967-70
Dyane 4 AY2	1968-75
Dyane 6 AYB	1970-73
GS 1015 cc.	1971-77
Mehari	1968-92

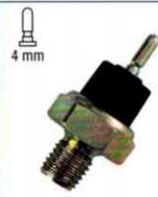

**Reemplaza / Suitable:**  
**Citroën** 5.403.215

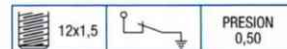

#### 12290

CITROEN	
LNA 652 cc.	1982-86
Visa Special, Club	1978-81
Visa II Special 652 cc.	1981-85



**Reemplaza / Suitable:**  
**Citroën** 75.492.054  
 95.495.551  
 95.578.879

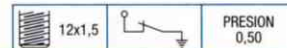

#### 12340

PEUGEOT	
504 Diesel	1982-83
505 GLD, GRD, SRD	1986-87
505 Turbo Diesel 2.5	1986-87



**Reemplaza / Suitable:**  
**Peugeot** 1131.38



#### IMPORTANTE:

Al pedir accesorios eléctricos, rogamos completen la referencia comenzando por 'F' (ejemplo: 381394 → F381394)

*Pour commander accessoires électriques, nous vous prions de compléter la référence en commençant par 'F'.*

When ordering electric accessories, please complete the reference by beginning with 'F'.



## ACCESORIOS ELÉCTRICOS

## ACCESSOIRES ELECTRIQUES / ELECTRIC ACCESSORIES



### MANOCONTACTOS PRESION DE ACEITE OIL PRESSURE SWITCHES MANOCONTACTS PRESSION D'HUILE

#### 12430

Aislante negro / Black colour

##### CITROEN COMM.

Jumpy 1580 SPI 1995 ->



Reemplaza / Suitable:



14x1,5



PRESION  
0,30±0.60

#### 12640

Aislante gris / Grey colour

##### CITROEN

Berlingo 1.7 Diesel (A9A) 1997 ->  
Berlingo 1.8 i (LFX) 1997 ->  
Berlingo 1.9 D (D9B, DW8) 1997 ->  
Evasion 1.8 i (XU7JP) 1997 ->  
Evasion 2.0 i (XU10J2C) 1997 ->  
Evasion 2.0 i Turbo 1997 ->  
Xantia Gasolina/Petrol 1997 ->  
XSara 1997 ->  
XSara Picasso 1.8 i 16V 2000 ->

##### PEUGEOT

206 1.9 D (DW8) 1998 ->  
306 Gasolina/Petrol 1997 ->  
406 1998 ->  
806 Gasolina/Petrol 1997 ->  
Boxer 1.9 D, Turbo D 1997 ->  
Partner 1.8 i (XU7JB) 1997 ->  
Partner 1.9 D (DW8) 1997 ->  
Expert / Ranch 1.8 i 1997 ->  
Expert / Ranch 1.9 D, TD 1997 ->



Reemplaza / Suitable:  
PSA 1131.C5



16x1,5



PRESION  
0,50

#### 14500

##### CITROEN

BX 19 GTI, TZI, 16V 1986-93  
CX Inj., Turbo, GTI 1981-89  
Visa GTI 1580 cc. 1985-89  
ZX 1.9 i Volcane 1991-92

##### PEUGEOT

205 GTI 1.6, 1.9 1984-93  
305 1.9 GTX, SR 1984-88  
309 1.6 i, 1.9 GTI, GTI 16V 1986-93  
405 1.6 i, 1.9 i (XU Inj.) 1987-93  
405 1.6 i, 1.8 l 1993-95  
405 MI 16 1988-93

##### TALBOT-SIMCA

Alpine 1.3, 1.5, 1.6, SX 1975-84  
Horizon GLS 1442-1592 1978-86  
Matra Bagheera. Rancho 1977-84  
Minx. Rapier 1.6 1984-86  
Simca 1000. 1100 1976-81  
Simca 1307. 1308. 1309 1978-86  
Solara 1980-84  
Tagora SX 2664 cc. 1982-84  
150 GT, S, SX 1977-86



6,35 mm



10x1



Reemplaza / Suitable:  
Alfa Romeo 60507256  
60507261  
60725114  
Citroën 97.516.535  
Fiat 82205408  
Land Rover PRC 4043  
Peugeot 1131.26, 27  
Talbot 0015444700

#### 14501

##### PEUGEOT

J 9



6,35 mm



16x1,5



Reemplaza / Suitable:  
PRESION  
0 - 8

#### 14580

##### PEUGEOT

Motores/Engines V6



5 / 6,35 mm



14x1,5



Reemplaza / Suitable:  
PRESION  
0 - 6  
0,60

### IMPORTANTE:

Al pedir accesorios eléctricos, rogamos completen la referencia comenzando por 'F' (ejemplo: 381394 → F381394)

Pour commander accessoires électriques, nous vous prions de compléter la référence en commençant par 'F'.

When ordering electric accessories, please complete the reference by beginning with 'F'.



**INTERRUPTORES LUZ DE STOP  
STOP LIGHT SWITCHES  
CONTACTEURS DE FEU STOP**



**INTERRUPTORES STOP HIDRAULICOS  
HYDRAULIC STOP LIGHT SWITCHES  
CONTACTEURS HYDRAULIQUES DE FEU STOP**



**INTERRUPTORES STOP MECANICOS  
MECHANICAL STOP LIGHT SWITCHES  
CONTACTEURS MECANIQUES DE FEU STOP**



**INTERRUPTORES STOP NEUMATICOS  
PNEUMATIC STOP LIGHT SWITCHES  
CONTACTEURS PNEUMATIQUES DE FEU STOP**

## ACCESORIOS ELÉCTRICOS

## ACCESSOIRES ELECTRIQUES / ELECTRIC ACCESSORIES

**INTERRUPTORES STOP HIDRAULICOS**  
**HYDRAULIC STOP LIGHT SWITCHES**  
**CONTACTEURS HYDRAULIQUES DE FEU STOP**
**21040**

PEUGEOT		TALBOT-SIMCA	
204	1966-69	Ariane, Aronde	1956-66
		Beaulieu, Chambord	
		Etoile, Elysée, Ranch	
		Simca 900, Special. (E)	1970-76
		Simca 1000, 1000 Rallye	1963-76
		Simca 1100 (F)	1967-74
		Simca 1200 (E)	1969-74
		Simca 1300, 1301, S	1963-70
		Simca 1500, 1501, S	1964-70

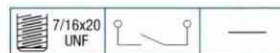

6,35 mm

**Reemplaza / Suitable:**  
**Renault** 08 57 030 400
**21050**

PEUGEOT		TALBOT-SIMCA	
203, 403		Aronde	1956-57
404	1960-65	Frianon, Vedette, Regence	-> 1956
404 Diesel	1962-67	Marly, Versailles, Vendôme	-> 1956
PEUGEOT COMM.			
J 7 Gasolina/Petrol	1965-79		
J 7 Diesel	1968 ->		
J 9 Gasolina/Petrol	1979 ->		
J 9 Diesel	1979-86		



6,35 mm

**Reemplaza / Suitable:**  
**Peugeot** 4608.13  
 4608.15  
**Renault** 08 54 250 300  
 77 01 348 720
**21060**

PEUGEOT		TALBOT-SIMCA	
204 Diesel	1968-74	Simca 1100 (F)	1967-72
		Simca 1300, 1301, S	1963-70
PEUGEOT COMM.			
J 9 Diesel	1979-86	Simca 1500, 1501, S	1964-70

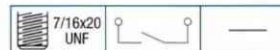

6,35 mm

**Reemplaza / Suitable:**  
**Peugeot** 4608.11  
 4040536724  
**Talbot** SG-87171030 E
**23010**
**UNIVERSAL**  
 Conecta al tensar el muelle.  
 Connects pulling the spring.  
 Connexion en tirant le ressort.
**23020**
**UNIVERSAL**  
 Conecta al destensar el muelle.  
 Connects pushing the spring.  
 Déconnexion en deserrant le ressort.

**Reemplaza / Suitable:**
**23010 23020****23060**

EBRO	
Tractores	1961-69
160	1961-69
183	1961-69

**Reemplaza / Suitable:**  
**Ebro** 13480 B
**23070**

DODGE-BARREIROS	
Tractores Hanomag	
R-355	
R-438	
R-440	

**Reemplaza / Suitable:**  
**RVI** 4881325027
**24010**

CITROEN	
C 25 E 1.8, 2.0	1981-93
C 25 D 1905 cc.	1988-93
C 25 D 2500, Turbo D	1981-93
PEUGEOT COMM.	
J 5	1988-93

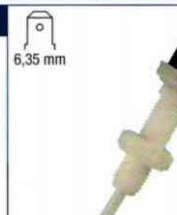

6,35 mm

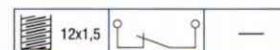
**Reemplaza / Suitable:**  
**Citroën** ZF-04.345.643  
 ZF-04.345.645  
**Peugeot** 4534.06
**IMPORTANTE:**
**Al pedir accesorios eléctricos, rogamos completen la referencia comenzando por 'F' (ejemplo: 381394 → F381394)**
*Pour commander accessoires électriques, nous vous prions de compléter la référence en commençant par 'F'.*

When ordering electric accessories, please complete the reference by beginning with 'F'.

# ACCESORIOS ELÉCTRICOS

## ACCESSOIRES ELECTRIQUES / ELECTRIC ACCESSORIES



### INTERRUPTORES STOP HIDRAULICOS HYDRAULIC STOP LIGHT SWITCHES CONTACTEURS HYDRAULIQUES DE FEU STOP

#### 24070

CITROEN		PEUGEOT		PEUGEOT COMM.	
LN, LNA	1976-86	104	1972-85	205 Van 1.1	1985-94
Visa	1981-89	204, 204 Diesel	1970-77	205 Van Diesel	1985-94
CITROEN COMM.		205 GTI 1580 cc.	1984-87	304 Van	1976-81
C 15 E 1118-1294 cc.	1987-88	304, 304 Diesel	1969-80	304 Van Diesel	1976-81
C 15 E 1124-1360 cc.	1984-87	305, 305 Diesel	1977-83	305 Van 1.5	1980-84
C 15 D 1769 cc.	1984-87	404, 404 Diesel	1966-75	TALBOT	
		504, 504 Diesel	1968-82	Samba	1981-86
		505 GL, GR, SR, 1.8, 2.0	1979-91		
		604 V6, Diesel, Turbo D	1975-87		



6,35 mm

Reemplaza / Suitable:	
Citroën	95.494.812
	95.495.530
	95.565.829
	95.578.666
Peugeot	4534.02
Talbot	7910 025 732



#### 24080

CITROEN		PEUGEOT		TALBOT	
AX	1989-91	104 S, ZS, 1.4	1981-83	Samba	1981-86
BX, CX, Visa	1983-93	106 C.D. (RHD)	1991-96		
C 15 E, C 15 E	1987-96	205	1983-94		
XM	1989-93	305	1983-88		
		309	1986-93		
		505, 604	1979-91		

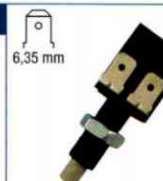

6,35 mm

Reemplaza / Suitable:	
Citroën	96.005.949
	96.039.131
Motor Ibérica	01500315-0
	01501024-0
Peugeot	4534.02, 04, 13
Renault	77 00 511 899
	77 00 544 807
	77 00 562 527

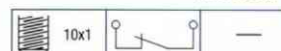

#### 24081

CITROEN		PEUGEOT		TALBOT	
AX	1989-91	104 S, ZS, 1.4	1981-83		
BX	1983-93	106 C.D. (RHD)	1991 ->		
C 15 E, C 15 D	1987-96	205	1983-94		
Visa	1978-89	305	1983-88		
XM	1989-96	309	1986-93		
		505	1979-91		
		604	1975-86		

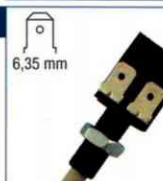

6,35 mm

Reemplaza / Suitable:	
Citroën	96.001.647
	96.005.949
	96.039.131
Peugeot	4534.02, .04
	4534.13
Renault	77 00 511 899
	77 00 562 527
	77 01 348 722

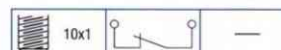

Contactos de plata / Silver contacts.

#### 24100

TALBOT-SIMCA		TALBOT Cont.		TALBOT-CHRYSLER	
Horizon	1978-86	Simca 1309 SX	1978-86	150 GL, GL SPL, GT	1977-81
Matra Bagheera	1973-80	Simca 1500, 1501, S	1970-75	150 LS, GLS	1977-86
Matra Rancho	1977-84	Simca 1510	1979-86	150 GT, SX, S	1977-86
Murena 1600, 2000	1980-84	Solara	1980-84	160, GT, 180, 1609, 1610	1970-78
Simca 1000, 1000 Rallye	1974-78	Solara Escorial 1.6	1985 ->	160 Diesel	1970-78
Simca 1100 (F)	1974-81	Tagora	1981-84	180, 2 l.	1972-81
Simca 1200 (E)	1974-83			2000 Diesel	1975-80
Simca 1300, 1301, S	1970-75			Alpine 1.3, 1.5, 1.6, SX	1975-84
Simca 1307, 1308	1975-86			Minx, Rapier 1.6	1984-86



6,35 mm

Reemplaza / Suitable:	
Peugeot	4534.08
Talbot	0016167500
	005591100
	30258400
	41719 B
	97516653 80
	SL-87171060

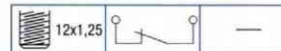

#### 24130

CITROEN		CITROEN Cont.	
Acadiane		CX 25 Diesel	1978-79
2 CV 6, Special, 3 CV AKS	1974-90	D Special, Super, Super 5	1968-75
Ami 6, Ami 8, C-8	1967-80	Dyane 4, 6	1973-82
Ami Super 1015 cc.	1973-76	GS	1973-81
C 32, C 35	1973-91	GSA	1980-86
CX 2000 1985 cc.	1974-85	Mehari	1974-88
CX 2.0 RE, TRE, X, Reflex	1979-80		
CX 2200	1974-79		
CX 2400	1976-85		

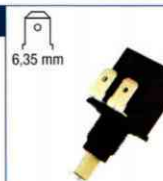

6,35 mm

Reemplaza / Suitable:	
Citroën	5.422.483
	5.472.060
	75.491.858
	95.494.332

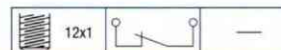

#### 24250

MOTOR IBERICA	
L-60.09, L-70.09	1992-99
L-80.095, L-75.095	1983-99
L-80.14, L-75.14	1988-93
M-90.15, M-75.15	1993-99
M-110.14, M-125.14	1988-93
M-110.15	1993-99
M-115.17	1993-99
M-125.17	1993-99
M-130.17	1988-99



Reemplaza / Suitable:	
Motor Ibérica	01500791-0

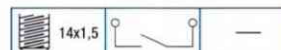

Cable 90 mm.

#### 24340

PEUGEOT	
405 1.4 GL, GR, (TU3F2)	1987-89
405 1.6, 1.9, Automatics	1987-92
405 1.6 i, 1.9 i, (XU Inj.)	1987-93
405 MI 16	1987-93
405 Diesel, Turbo D	1988-93
505 con/with ABS	1979-91
605 2.0, 2.0i	1990-96
605 3.0 i V6, V6 24V	1990-96
605 Diesel, Turbo Diesel	1990-96



Reemplaza / Suitable:	
Peugeot	4534.09
	4534.15

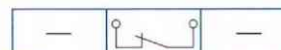

### IMPORTANTE:

Al pedir accesorios eléctricos, rogamos completen la referencia comenzando por 'F' (ejemplo: 381394 → F381394)

Pour commander accessoires électriques, nous vous prions de compléter la référence en commençant par 'F'.

When ordering electric accessories, please complete the reference by beginning with 'F'.



## ACCESORIOS ELÉCTRICOS

## ACCESSOIRES ELECTRIQUES / ELECTRIC ACCESSORIES



### INTERRUPTORES STOP HIDRAULICOS HYDRAULIC STOP LIGHT SWITCHES CONTACTEURS HYDRAULIQUES DE FEU STOP

#### 24070

CITROEN		PEUGEOT		PEUGEOT COMM.	
LN, LNA	1976-86	104	1972-85	205 Van 1.1	1985-94
Visa	1981-89	204, 204 Diesel	1970-77	205 Van Diesel	1985-94
<b>CITROEN COMM.</b>		205 GTI 1580 cc.	1984-87	304 Van	1976-81
C 15 E 1118-1294 cc.	1987-88	304, 304 Diesel	1969-80	305 Van Diesel	1976-81
C 15 E 1124-1360 cc.	1984-87	305, 305 Diesel	1977-83	305 Van 1.5	1980-84
C 15 D 1769 cc.	1984-87	404, 404 Diesel	1966-75	<b>TALBOT</b>	
		504, 504 Diesel	1968-82	Samba	1981-86
		505 GL, GR, SR, 1.8, 2.0	1979-91		
		604 V6, Diesel, Turbo D	1975-87		



6,35 mm

**Reemplaza / Suitable:**  
**Citroën** 95.494.812  
 95.495.530  
 95.565.629  
 95.578.666  
**Peugeot** 4534.02  
**Talbot** 7910 025 732

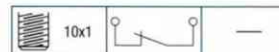

#### 24080

CITROEN		PEUGEOT		TALBOT	
AX	1989-91	104 S, ZS, 1.4	1981-83	Samba	1981-86
BX, CX, Visa	1983-93	106 C.D. (RHD)	1991-96		
C 15 E, C 15 E	1987-96	205	1983-94		
XM	1989-93	305	1983-88		
		309	1986-93		
		505, 604	1979-91		

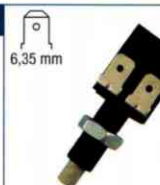

6,35 mm

**Reemplaza / Suitable:**  
**Citroën** 96.005.949  
 96.039.131  
**Motor Ibérica** 01500315-0  
 01501024-0  
**Peugeot** 4534.02, 04, 13  
**Renault** 77 00 511 899  
 77 00 544 807  
 77 00 562 527

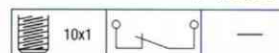

#### 24081

CITROEN		PEUGEOT	
AX	1989-91	104 S, ZS, 1.4	1981-83
BX	1983-93	106 C.D. (RHD)	1991 ->
C 15 E, C 15 D	1987-96	205	1983-94
Visa	1978-89	305	1983-88
XM	1989-96	309	1986-93
		505	1979-91
		604	1975-86

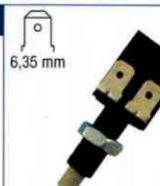

6,35 mm

**Reemplaza / Suitable:**  
**Citroën** 96.001.647  
 96.005.949  
 96.039.131  
**Peugeot** 4534.02, .04  
 4534.13  
**Renault** 77 00 511 899  
 77 00 562 527  
 77 01 348 722

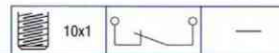

Contactos de plata / Silver contacts.

#### 24100

TALBOT-SIMCA		TALBOT Cont.		TALBOT-CHRYSLER	
Horizon	1978-86	Simca 1309 SX	1978-86	150 GL, GL SPL, GT	1977-81
Matra Bagheera	1973-80	Simca 1500, 1501, S	1970-75	150 LS, GLS	1977-86
Matra Rancho	1977-84	Simca 1510	1979-86	150 GT, SX, S	1977-86
Murena 1600, 2000	1980-84	Solara	1980-84	160, GT, 180, 1609, 1610	1970-78
Simca 1000, 1000 Rallye	1974-78	Solara Escorial 1.6	1985 ->	160 Diesel	1970-78
Simca 1100 (F)	1974-81	Tagora	1981-84	180, 2 l.	1972-81
Simca 1200 (E)	1974-83			2000 Diesel	1975-80
Simca 1300, 1301, S	1970-75			Alpine 1.3, 1.5, 1.6, SX	1975-84
Simca 1307, 1308	1975-86			Minx, Rapier 1.6	1984-86



6,35 mm

**Reemplaza / Suitable:**  
**Peugeot** 4534.08  
**Talbot** 0016167500  
 005591100  
 30258400  
 41719 B  
 97516653 80  
 SL-87171060

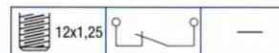

#### 24130

CITROEN		CITROEN Cont.	
Acadiane		CX 25 Diesel	1978-79
2 CV 6, Special, 3 CV AKS	1974-90	D Special, Super, Super 5	1968-75
Ami 6, Ami 8, C-8	1967-80	Dyane 4, 6	1973-82
Ami Super 1015 cc.	1973-76	GS	1973-81
C 32, C 35	1973-91	GSA	1980-86
CX 2000 1985 cc.	1974-85	Mehari	1974-88
CX 2.0 RE, TRE, X, Reflex	1979-80		
CX 2200	1974-79		
CX 2400	1976-85		

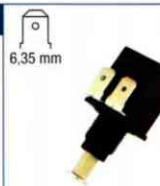

6,35 mm

**Reemplaza / Suitable:**  
**Citroën** 5.422.483  
 5.422.060  
 75.491.858  
 95.494.332

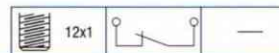

#### 24250

MOTOR IBERICA	
L-60.09, L-70.09	1992-99
L-80.095, L-75.095	1993-99
L-80.14, L-75.14	1988-93
M-90.15, M-75.15	1993-99
M-110.14, M-125.14	1988-93
M-110.15	1993-99
M-115.17	1993-99
M-125.17	1993-99
M-130.17	1988-99



Cable 90 mm.

**Reemplaza / Suitable:**  
**Motor Ibérica** 01500791-0

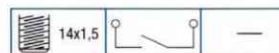

#### 24340

PEUGEOT	
405 1.4 GL, GR. (TU3F2)	1987-89
405 1.6, 1.9, Automatics	1987-92
405 1.6 i, 1.9 i. (XU Inj.)	1987-93
405 MI 16	1987-93
405 Diesel, Turbo D	1988-93
505 con/with ABS	1979-91
605 2.0, 2.0i	1990-96
605 3.0 i V6, V6 24V	1990-96
605 Diesel, Turbo Diesel	1990-96



**Reemplaza / Suitable:**  
**Peugeot** 4534.09  
 4534.15

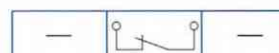

### IMPORTANTE:

Al pedir accesorios eléctricos, rogamos completen la referencia comenzando por 'F' (ejemplo: 381394 → F381394)

Pour commander accessoires électriques, nous vous prions de compléter la référence en commençant par 'F'.

When ordering electric accessories, please complete the reference by beginning with 'F'.

**ACCESORIOS ELÉCTRICOS**
**ACCESSOIRES ELECTRIQUES / ELECTRIC ACCESSORIES**

MATERIAL ELECTRICO / MATERIEL ELECTRIQUE / ELECTRIC PARTS

**INTERRUPTORES STOP HIDRAULICOS  
HYDRAULIC STOP LIGHT SWITCHES  
CONTACTEURS HYDRAULIQUES DE FEU STOP**
**24885**

Aislante rojo / Red colour

CITROEN		PEUGEOT		PEUGEOT Cont.	
C3 -> N° 09428, 09498	2002 ->	206 -> N° 09456	1998 ->	406 Cruise Control	1996-04
C5 -> N° 09491, 09610	2001 ->	206 CC -> N° 09456	2000 ->	406 Break Cruise Control	1999-04
C5 Break	2001 ->	206 SW -> N° 09456	2002 ->	406 Coupe Cruise Control	1999-04
C8 -> N° 10562	2002 ->	307 -> N° 09531, 09492	2000 ->	607 -> N° 09519	2000 ->
Evasion Cruise Control	1997-02	307 Break -> 09531, 09492	2002 ->	806	1999-02
Jumpy	2000-03	307 CC -> 09531, 09492	2003 ->	807	2002 ->
		307 SW -> 09531, 09492	2002 ->	Expert -> N° 09793	1998 ->

**Reemplaza / Suitable:**

Fiat	9622578880
	9643184680
PSA	4534.27
	4534.37

**24896**

Aislante marrón / Brown colour

CITROEN		PEUGEOT		PEUGEOT Cont.	
C8 2.0, 2.2	2002 ->	206 Gasolina/Petrol	1998-04	607 2.0 HDI	2000 ->
C8 2.0 16V	2005 ->	206 CC 1.6 16V, 2.0 S16	2000-04	607 2.2 HDI (9D,9U)	2000 ->
C8 2.0 HDI, 2.2 HDi	2002 ->	206 SW	2002-04	607 2.2 16V (9D,9U)	2005 ->
Evasion 2.0 HDi	1999-02	406 2.0 HDi 90 cv, Break	1999-04	806 2.0 HDI, HDI 16V	1999-02
Jumpy 2.0 HDi	1999 ->	406 2.2, Break, Coupe	2000-04	807	2002 ->
		406 2.2 HDI, Break, Coupe	2000-04	Expert 2.0 HDI	2000 ->
		406 3.0 V6, Break, Coupe	2000 ->		

**Reemplaza / Suitable:**

PSA	4534.28
Fiat	9639888380



**24897**

Aislante negro / Black colour

CITROEN		CITROEN Cont.		PEUGEOT Cont.	
Berlingo 1.1 i, 1.4 i, 1.8 i	2003 ->	XSara 1.8 VTS	2003-04	206 1.6 16V	2003 ->
Berlingo 1.6 16V	2003 ->	XSara 1.9 D 70 cv.	2003-05	206 2.0 HDI 90	2003 ->
Berlingo 1.6 HDI 75/90	2003 ->	XSara 2.0 16V 136 cv.	2003-05	206 2.0 S16 / GTI	2003 ->
Berlingo 1.8 D 59 cv.	2002-04	XSara 2.0i 16V 163 cv.	2003-05	Partner 1.1 i, 1.4 i, 1.8 i	2003 ->
Berlingo 1.9 D 70 cv.	2002-04	XSara 2.0 HDI 90/109	2003-05	Partner 1.6 16V	2003 ->
Berlingo 2.0 HDI 90	2003 ->	<b>PEUGEOT</b>		Partner 1.6 HDI 75/90	2003 ->
XSara 1.4 i	2003-05	206 1.1 i, 1.4 i	2003 ->	Partner 1.8 D 59 cv.	2002-04
XSara 1.4 HDI 68 cv.	2003-05	206 1.4 16V	2003 ->	Partner 1.9 D 70 cv.	2002-04
XSara 1.6 16V	2003-05	206 1.4 HDI	2003 ->	Partner 2.0 HDI 90	2003 ->

**Reemplaza / Suitable:**

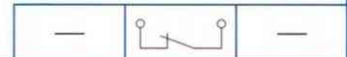
PSA	9634667980
-----	------------

**NEW 24898**

Aislante blanco / White colour

CITROEN		PEUGEOT	
Berlingo	2003 ->	1007	2005 ->
C2	2003 ->	206	1998-07
C3	2001 ->	206 Cabrio	2000-07
C3 Pluriel	2003 ->	307	2001 ->
C5, C5 Break	2001-04	607	2000 ->
XSara	2000-04	Partner	2003 ->
XSara Picasso	2000-04		

**Reemplaza / Suitable:**

Citroen	96.434.788.80
Peugeot	4534.40

**NEW 24899**

Aislante verde / Green colour

PEUGEOT	
1007	2005 ->
207	2006 ->
307	2002 ->
308	2007 ->
407	2004 ->
807	2002 ->

**Reemplaza / Suitable:**

Citroen	96.506.884.80
Peugeot	4534.48

**25020**

CITROEN	
2 CV 4, 3 CV AK	1970-73
2 CV 6, 3 CV AKS	1970-73
Dyane AYA	1967-70
Dyane 4 AYA2	1968-73
Dyane 6 AYB	1970-73
GS, GS Club	-> 1973
Mehari	1968-74
SM	1970-74

**Reemplaza / Suitable:**

Citroën	5.420.474
	AY-57602-A
	AY-95769602-A

**IMPORTANTE:**

Al pedir accesorios eléctricos, rogamos completen la referencia comenzando por 'F' (ejemplo: 381394 → F381394)

*Pour commander accessoires électriques, nous vous prions de compléter la référence en commençant par 'F'.*

When ordering electric accessories, please complete the reference by beginning with 'F'.



ACCESORIOS ELÉCTRICOS

ACCESSOIRES ELECTRIQUES / ELECTRIC ACCESSORIES



**TERMO-RESISTENCIAS, SENSORES, TERMOCONTACTOS  
TEMPERATURE TRANSMITTERS, SENSORS  
THERMISTANCES, SENSEURS, THERMOCONTACTS**



**TERMO-RESISTENCIAS  
TEMPERATURE SENDING UNITS  
THERMISTANCES**



**SENSORES  
SENSORS  
SENSEURS**

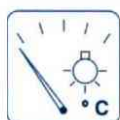

**TERMO-RESISTENCIA - TERMOCONTACTO  
THERMISTOR - THERMOCONTACT  
THERMISTANCE - THERMOCONTACT**

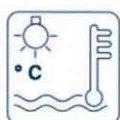

**TERMOCONTACTOS TEMPERATURA  
BIMETALLIC TEMPERATURE CONTACTS  
THERMOCONTACTS TEMPERATURE**



**TERMOCONTACTOS VENTILADOR  
BIMETALLIC TEMPERATURE CONTACTS FOR FAN  
THERMOCONTACTS POUR VENTILATEUR**



**TERMOCONTACTOS DOBLE VENTILADOR O DOS VELOCIDADES  
THERMO-SWITCHES FOR DOUBLE FAN OR TWO SPEEDS  
THERMOCONTACTS DOUBLE VENTILATEUR OU À DEUX VITESSES**



# ACCESORIOS ELÉCTRICOS

## ACCESSOIRES ELECTRIQUES / ELECTRIC ACCESSORIES



**TERMO-RESISTENCIAS**  
TEMPERATURE SENDING UNITS  
THERMISTANCES



### 30260

CITROËN		PEUGEOT	
C 25 E 1.8, 2.0	1981-85	204	1970-76
		304, 304 Van	1969-80
		305, 305 Van	1977-88
		504	1979-82
		505	1979-89
		604	1975-86
		J 5 1.8, 2.0	1981-89
		J 7 Diesel	1968-86
		J 9	1979-86



**Reemplaza / Suitable:**  
Citroën 79.10.247.507  
Fiat 7910247507  
Peugeot 0242.20  
Renault 77 00 767 336  
77 01 348 143  
79 10 245 551  
79 10 245 553  
0521548200

Talbot



### 30280

CITROËN		PEUGEOT	
BX 19 GTI	1986-89	205 1.0, 1.1, 1.3 (F)	1987-88
Visa 1.6 GTI	1985-87	205 1.4, 1.4 GT (F)	1987-88
		205 1.6 GTI	1984-87
		305 1.9 GTX	1985-88
		309 1.1, 1.3, 1.5, 1.6, 1.9	1986-93
		309 1.9 GTI	1987-93
		309 Diesel 1.7, 1.9	1986-93
		405 MI 16	1987-93



**Reemplaza / Suitable:**  
Citroën 91.517.505  
Peugeot 0242.50



### 30290

CITROËN	
BX 16, BX 19	1983-93
BX 19 GTI	1989-93
BX 19 GTI 16V	1988-93
BX 19 4x4	1989-93
Visa 1.6 GTI	1988-89
ZX 1.9 i	1991-92



**Reemplaza / Suitable:**  
Citroën 96.635.573



### 31020

CITROËN		PEUGEOT		TALBOT	
C 25 D 2.5, Turbo D	1981-87	104	1972-85	Samba	1981-86
CX	1979-89	204, 304, 404	1960-77		
CX 2.5 Diesel, DI Turbo	1978-89	504	1968-82		
Visa Crono	1982-87	J 5 2.5 Diesel	1981-88		
Visa 1.6 GTI	1985-89	J 7 Gasolina/Petrol	1965-79		
		J 9 Diesel	1979-86		



6,35 mm

**Reemplaza / Suitable:**  
Citroën 95.548.678  
95.581.212  
Peugeot 0242.14  
0242.40  
Renault 60 00 001 355  
77 00 503 200  
77 01 349 086



### 31280

Aislante negro / Black colour

PEUGEOT		TALBOT-CHRYSLER	
205 Diesel	1983-87	Alpine 1.3, 1.5, 1.6	1975-84
205 Van Diesel	1985-94	Horizon	1978-86
305 Diesel	1984-88	Matra Bagheera, Rancho	1977-84
305 Van	1981-88	Minx, Rapier 1.6	1984-86
405 1.4 GL (F)	1987-93	Murena 1600, 2200	1980-84
504	1974-82	Simca (F) (E)	1976-86
505	1979-91	Solara	1980-84
604	1975-86	Tagora 2.2 GL, GLS	1981-84
J 5 1.8, 2.0	1981-89	150, 160, 180, 1609, 1610	1970-86



6,35 mm

**Reemplaza / Suitable:**  
Peugeot 0242.63  
Talbot 0015794500  
97 509 510 80  
SM-71446000



### 31370

Aislante rojo / Red colour

CITROËN		PEUGEOT		PEUGEOT COMM.	
AX	1987-91	205	1983-93	J 5	1988-93
BX 19 GTI, 16v, 4X4	1986-93	305	1983-88		
C 15 E, C 15 D	1984-94	309	1986-93	Tagora GL, GLS, 2156 cc.	1981-84
C 25 E, C 25 D	1985-93	405	1987-93	Tagora SX 2664 cc.	1982-84
Visa	1984-89	405 1.6 i	1993-95		
ZX 1.1 Carb.	1991-93	405 1.9 Diesel	1993-95		
		505	1986-91		
		604 Diesel, Turbo D	1981-87		



6,35 mm

**Reemplaza / Suitable:**  
Citroën 97.509.510  
Peugeot 1337.72  
PSA 0042790300



### 32280

Aislante blanco / White colour

PEUGEOT	
205 1.6 GTX (E)	1986-94
309 1.6 SR (E)	1987-92



**Reemplaza / Suitable:**  
Peugeot 0242.64



Motores/Engines/Moteurs:  
J2.

### IMPORTANTE:

**Al pedir accesorios eléctricos, rogamos completen la referencia comenzando por 'F' (ejemplo: 381394 → F381394)**  
*Pour commander accessoires électriques, nous vous prions de compléter la référence en commençant par 'F'.*  
When ordering electric accessories, please complete the reference by beginning with 'F'.

## ACCESORIOS ELÉCTRICOS

## ACCESSOIRES ELECTRIQUES / ELECTRIC ACCESSORIES

**TERMO-RESISTENCIAS**  
**TEMPERATURE SENDING UNITS**  
**THERMISTANCES**
**32290**

Aislante azul, Aro rojo / Blue colour, Red ring

CITROËN		PEUGEOT		PEUGEOT COMM.	
AX	1992-96	106	1992-96	Boxer 1.9 D, 1.9 TD	1994-95
Berlingo Diesel	1996-00	306	1993-97	Expert	1996-00
Evasion	1994-98	405	1993-95	Partner	1996-98
Jumper Diesel, Turbo D	1994-98	406	1996-98	806	1994-98
Jumpy 1.9 D, TD	1995-98	605	1990-96		
Xantia	1993-98				
XM	1989-96				
XSara	1997-00				
ZX	1991-96				

Modelos con Aire Acondicionado.  
 Models with Air Conditioned.  
 Modèles avec Air Conditionné.



Reemplaza / Suitable:  
 Citroën 96.018.426  
 Peugeot 1338.09

**32295**

Aislante azul, Aro azul / Blue colour, blue ring

CITROËN		PEUGEOT	
Xantia 2.9i 24V	1997-98	406 3.0i 24V (ES9J4)	1996-99
Xantia 3.0i V6	1998-01	406 3.0i V6 (ES9J4S)	2000-01
Xantia Break 3.0i V6	1998-01	406 Break 3.0i 24V	1997-99
XM 3.0i V6	1997-00	406 Break 3.0i V6	2000-01
XM Break 3.0i V6	1997-00	406 Coupe 3.0i 24V	1997-99
		406 Coupe 3.0i V6	2000-01
		607 3.0i V6 24V	2000-01



Reemplaza / Suitable:  
 Peugeot 1338.77

**32380**

Aislante azul, Aro marrón / Blue colour, Brown ring

CITROËN		PEUGEOT	
Evasion 2.0 i Turbo	1994-98	406 2.0 i Turbo SV	1996-98
Xantia 2.0 i Turbo	1995-98	605 2.0 i Turbo	1991-96
XM 2.0 i Turbo	1990-94	806 2.0 i Turbo	1994-98

Motores/Engines/Moteurs:  
 XU10J2TE.

Modelos con Aire Acondicionado.  
 Models with Air Conditioning.  
 Modèles avec Air Conditionné.



Reemplaza / Suitable:  
 Citroën 96.164.554  
 PSA 1338.34

**32440**

CITROËN		PEUGEOT	
BX 16, BX 19	1989-93	205 1.6 (XU51C)	1991-94
BX 19 GTI, TZI	1986-93	205 1.6 i Automatic	1991-94
ZX 1.6 i (XU5M)	1991-92	405 1.6, 2.0. (Carb. XU)	1993-95
ZX 1.9 i Volcane	1991-92	405 1.6 i, Automatic	1993-95
		405 1.8 i, 2.0 i	1993-95

Temperatura de aceite.  
 Oil Temperature.  
 Température d'huile.



Reemplaza / Suitable:  
 PSA 0242.81

**33010**

Aislante azul / Blue colour

CITROËN		PEUGEOT	
AX 11 i, 14 i. Monopoint	1993-94	106 Injection Monopoint	1991-96
BX 19 GTI, TZI, GTI 16V	1986-93	205 1.6 GTI, 1.9 GTI	1983-93
C 15 E 1.4 i Monopoint	1995-98	305 Injection (XU9J)	1986-88
CX 25 Inj., Turbo	1983-89	306 1.1 i, 1.4 i, 1.6 i	1993-97
Jumpy 1580 SPI	1995-98	309 Injection	1986-93
Visa 1.6 GTI	1985-89	405 Injection	1987-93
XM 2.0 i, 3.0 i V6	1989-93	505 GTI, STI, Inj., Turbo	1984-91
ZX Injection Monopoint	1991-96	605 2.0 SRI, SVI	1990-91



Reemplaza / Suitable:  
 Citroën 91.514.549  
 Peugeot 0242.46

**33020**

Aislante blanco / White colour

CITROËN	
CX 2400 Inj.	1977-84



Reemplaza / Suitable:

**IMPORTANTE:**

Al pedir accesorios eléctricos, rogamos completen la referencia comenzando por 'F' (ejemplo: 381394 → F381394)  
 Pour commander accessoires électriques, nous vous prions de compléter la référence en commençant par 'F'.  
 When ordering electric accessories, please complete the reference by beginning with 'F'.



**ACCESORIOS ELÉCTRICOS**
**ACCESSOIRES ELECTRIQUES / ELECTRIC ACCESSORIES**

**TERMO-RESISTENCIAS**  
**TEMPERATURE SENDING UNITS**  
**THERMISTANCES**

**33070**

Aislante verde. Aro violeta / Green colour, Violet ring

CITROËN	PEUGEOT
AX 1.1 i 1124 cc. 1992-96	106 1.1 i, 1.3 i, 1.3 XSI 1991-96
AX GTI 1360 cc. 1991-96	205 1.2 i, 1.4 i. Monopoint 1989-94
XM 2.0i Monopoint XT 1990-94	306 1.1 i XN, XA 1994-97
XM 2.0 i (XU10J2) 1994-96	306 1.4 i XN, XR, XA, XRA 1993-97
XM 2.0 i 16V 1994-96	309 1.6 i (XU5M) 1991-93
XM 3.0 V6, 3.0 V6 24V 1994-96	405 1.6 GLJ (XU5M) 1993-95
ZX 1.4 i Monopoint 1992-93	605 2.0 i SLI 110 cv. 1990-94
ZX 1.6 i, 1.9 i 1991-93	605 2.0 i SRI, SVI 1991-96
	605 SR30, SV30, SV24 1990-96

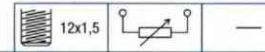
**Reemplaza / Suitable:**  
 Alfa Romeo 60576529  
 Citroën 95.640.493  
 Peugeot 1920.C4

**33090**

Aislante negro / Black colour

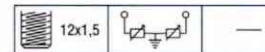
PEUGEOT
Astra 2.0 i, 2.0 i GSI 16V 1991-95
Omega 3000 GSI 1987-94
Senator A. Senator B 1983-93

**Reemplaza / Suitable:**  
 Alfa Romeo 60800522  
 Bosch 0280 130 032  
 G.M. 90183892  
 Opel 1338446  
 1338452  
 Porsche 92860612600  
 Volvo 1346030-8  
 3433477-1

**33120**

Aislante verde. Aro amarillo / Green colour, Yellow ring

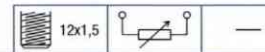
CITROËN	PEUGEOT
Berlingo 1.8 i (XU7JB) 1997-00	106 1.1 i, 1.4 i, 1.6 i 1996-98
Evasion 1.8 i, 2.0 i 1994-98	306 1.8 i, 2.0 i, 16V 1993-98
Jumper 2.0 i, 2.5 D, 2.5 TD 1994-98	405 1.8 i, 2.0 i 1993-95
Saxo 1.6 i VTL, VTR 1997 ->	406 1996-98
Xantia Injection 1993-98	605 2.0 i 16V, Turbo D 1994-96
XM 2.0 i 16V (XU10J4R) 1994-96	806 1.8 i, 2.0 i 1994 ->
XM 2.5 Turbo D (DK5ATE) 1994-96	Boxer 1994 ->
XSara Injection 1997 ->	Expert 1.8 i (XU7JP) 1996 ->
ZX 1992-96	Partner, Ranch. 1996-97

**Reemplaza / Suitable:**  
 Citroën 96.131.470  
 Fiat 9613147080  
 Peugeot 1920.K9

**33180**

Aislante gris. Aro blanco / Grey colour, White ring

CITROËN	PEUGEOT	PEUGEOT Cont.
AX GTI, GTI Top Ten 1991-96	106 XSI, Rallye 1991-96	405 1.9 i (XU9J2 D6D) 1991-93
BX 19 GTI, TZI, 4x4 1989-93	106 1.6 i (TU5JP, TU5J2) 1996 ->	405 2.0 i (XU10J2C) 1993-95
Evasion 2.1 Turbo D 1997-00	106 1.6 i 16V (TU5J4) 1996 ->	605 2.0 i SLI 110 cv. 1990-94
Saxo 1.6 i, 1.6 i 16V 1996 ->	205 1.6 i GTI, 1.9 GTI 1989-94	605 2.0 i SRI, SVI 1990-91
Xantia 2.1 Turbo D 1995-00	306 1.6 i XR, XS, XT 1993-97	605 3.0 V6, 3.0 V6 24V 1990-94
XM 2.0 i, 16V, 3.0 V6 1989-96	309 1.6 i, 1.9 GTI 1989-93	605 Automatics 1990-96
XSara 1.6 i (TU5JP) 1997 ->	405 1.6 GLJ (XU5M) 1991-93	
ZX 1.6i (XU5M) ->PR-6015 1991-93	405 1.6 i GL, GR, SR, Break 1993-95	
ZX 1.9 i Volcane 1991-92	405 1.8 i (XU7JP) 1993-95	

**Reemplaza / Suitable:**  
 Citroën 95.640.497  
 Peugeot 1920.C5

**33185**

Aislante gris / Grey colour

CITROËN	PEUGEOT
Evasion 1994-02	306 1993-00
Jumper 1994-02	405 1987-95
Xantia 1994-00	406 1996-00
XSara 1997-02	Boxer 1994-02
ZX 1991-97	



**Reemplaza / Suitable:**  
 PSA 1920.T0

Cable 180 mm.

**33190**

Aislante verde. Aro gris / Green colour, Grey ring

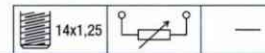
CITROËN	CITROËN COMM.	PEUGEOT
AX 15 D, TD 1994-98	C 15 D PR-6744-> 1993 ->	106 1.5 D CEE 19.5 1994-98
Berlingo 1.8 D, 1.9 D 1996-98	Jumper 1.9 Diesel (XUD9AU) 1994-98	306 1.7 D, 1.9 D 1993-98
Evasion 1.9 TD, 2.1 TD 1995-98	Jumper 2.5 D, 2.5 Turbo D 1994-98	406 1.9 SD, 1.9 TD, 2.1 TD 1996-98
Saxo 1.5 Diesel 1997-00	Jumpy 1.9 D, 1.9 Turbo D 1995-98	605 2.1 SRDT, SLDT, SVDT 1995-98
Xantia 1.9 TD, 2.1 TD 1993-96		Boxer 1.9 D (XUD9AU) 1994-95
XM 2.1 D, Turbo D 1989-96		Expert, Partner, Ranch 1996 ->
XSara 1.9 Turbo D 1997-00		
ZX 1.8 D, 1.9 D, Turbo D 1991-94		

**Reemplaza / Suitable:**  
 PSA 1338.47

**33255**

Aislante blanco / White colour

CITROËN
C1 1.0 2005 ->

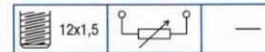
PEUGEOT
107 1.0 2005 ->

**Reemplaza / Suitable:**  
 PSA 1920.KP  
 Toyota 89422-0H010  
 89422-33030

**IMPORTANTE:**

Al pedir accesorios eléctricos, rogamos completen la referencia comenzando por 'F' (ejemplo: 381394 → F381394)  
 Pour commander accessoires électriques, nous vous prions de compléter la référence en commençant par 'F'.  
 When ordering electric accessories, please complete the reference by beginning with 'F'.



## ACCESORIOS ELÉCTRICOS

## ACCESSOIRES ELECTRIQUES / ELECTRIC ACCESSORIES



**SENSORES  
SENSORS  
SENSEURS**

### 33400

Aislante verde, Aro blanco / Green colour, White ring

CITROEN		PEUGEOT	
Evasion Turbo SX, VSX	1994-98	406 1.8 i (XU7JB)	1996-98
Xantia Turbo CT	1995-98	406 2.0 i 16V, Coupe	1996-98
XM 2.0 i Turbo	1990-94	406 2.0 i Turbo SV	1996-98
		605 2.0 i SRTI, SVTI	1991-98
		806 2.0 i Turbo ST, SV	1994-98

Motores/Engines/Moteurs:  
XU10J2TE.



**Reemplaza / Suitable:**  
Citroën 96.164.556  
Fiat 9616455680  
Peugeot 1920.Q2

12x1,5



### NEW 33506

Aislante negro / Black colour

CITROEN		PEUGEOT		PEUGEOT Cont.	
AX 1.1	1986-97	106 1.1 i	1991-96	205 II 1.1	1989-98
ZX 1.4i	1991-97	106 II 1.1 i	1996->	306 1.4 SL	1994->



**Reemplaza / Suitable:**

—



### 33510

Aislante gris / Grey colour

CITROEN		PEUGEOT	
Berlingo 1.4 i X, SX	1996 ->	106 1.4 i (TU3JP)	1996 ->
Saxo 1.4 i SX, VSX	1996 ->	106 1.6 i 16V (TU5J4)	1996 ->
Saxo 1.6 i 16V VTS	1997 ->	Partner 1.4 i (TU3JP)	1996 ->
XSara 1.4 i LS, SX	1998 ->		



**Reemplaza / Suitable:**  
PSA 1920.1J

—



### NEW 33511

Aislante gris / Grey colour

CITROEN		PEUGEOT	
Saxo 1.6 VTL, VTR	1996->	206 1.6i	1998->
Saxo 1.6 VTL, VTR	1996->	306 1.6 SR	1994-00
Xsara 1.6i	1997-00	306 Break 1.6	1997-00
Xsara Picasso 1.6	2000->		



**Reemplaza / Suitable:**  
Citroën 1920.6C

Peugeot 1920.6C

—



### 33600

Aislante verde / Green colour

CITROEN		PEUGEOT	
Berlingo 1.1 i (HDY,HDZ)	1996 ->	106 954 i, 1.1 i	1996 ->
Berlingo 1.4 i Depol CEE	1996 ->	106 1.6 i 16V (TU5J4)	1996 ->
Saxo 1.0 i, 1.1 i, 1.4 i	1996 ->	206 1.1 i, 1.4 i, 1.6 i	1998 ->
Saxo 1.6 i 16V VTS	1997 ->	306 1.4 i Depol CEE	1997 ->
XSara 1.4 i Depol CEE	1997 ->	306 1.6 i (TU5JP) N°7875->	1997 ->
XSara 1.6 i N°7875->	1997 ->		
XSara Picasso 1.6 i 100 cv.	2000 ->	<b>PEUGEOT COMM.</b>	
		Ranch 1.1 i (GPL)	1996 ->
		Ranch 1.4 i Depol CEE	1996 ->



**Reemplaza / Suitable:**

Alfa Romeo 60573388  
Bosch 0280130055  
BMW 13622242184  
13641288158  
Chrysler 4720598  
Fiat 7738223  
Ford 7072695  
PSA 1920.3F  
Rover MVK 10002  
Saab 75 63 562

12x1,5



### 33660

Aislante blanco / White colour

CITROEN		PEUGEOT	
AX 954, 1.1, 1.4. (Carb. TU)	1986-92	205 1.4 (TU3CP)	1983-90
AX 954 i, 1.1 i. (TU Inj.)	1991-96	<b>PEUGEOT COMM.</b>	
AX 1.3 Sport (TU2/4)	1987-92	J 5 1.9 (XN1TA)	1989-93
AX 1.4 i (TU3FM)	1991-96		
AX 1.4 GTI (TU3FJ2)	1986-96		
BX 1.1, 1.6, 1.9. Carb.	1983-93		
BX 1.4 i, 1.6 i, 1.9 i	1987-93		
CX 25 RI, TRI, GTI	1985-89		
CX 25 Turbo Injection	1985-89		

Temperatura de aceite.  
Oil temperature.  
Temperature d'huile.



**Reemplaza / Suitable:**  
Citroën 95.631.379  
Peugeot 0242.61

14x1,25



### IMPORTANTE:

**Al pedir accesorios eléctricos, rogamos completen la referencia comenzando por 'F' (ejemplo: 381394 → F381394)**  
*Pour commander accessoires électriques, nous vous prions de compléter la référence en commençant par 'F'.*  
When ordering electric accessories, please complete the reference by beginning with 'F'.

# ACCESORIOS ELÉCTRICOS

## ACCESSOIRES ELECTRIQUES / ELECTRIC ACCESSORIES



MATERIAL ELECTRICO / MATERIEL ELECTRIQUE / ELECTRIC PARTS

**SENSORES**  
**SENSORS**  
**SENSEURS**

33705		Aislante verde / Green colour		Reemplaza / Suitable:
<b>CITROEN</b>				<b>Citroën</b> 96.368.023
Berlingo 1.9 D	1998 ->			<b>Peugeot</b> 1338.88
C5 1.8i 16V, Break	2000 ->			1338.A7
C5 2.0i 16V, Break	2001 ->			
C5 2.0i 16V HPI	2001 ->			
C5 3.0i V6, Break	2001 ->			
C8 2.0i	2002 ->			
C8 2.0 HDI	2002 ->			
C8 2.2i	2002 ->			
C8 2.2 HDI	2002 ->			
Evasion 2.0i 16V	2000-02			
Evasion 2.0 HDI	1999-02			
Evasion 2.0 HDI 16V	2001 ->			
Jumpy 1.9 D	2000 ->			
Jumpy 2.0 HDI	2000 ->			
Jumpy 2.0i 16V	2000 ->			
XSara 1.9 D, Coupe, Break	1998 ->			
XSara 2.0i 16V, Coupe, Break	1997 ->			
XSara Picasso 1.8i 16V	2000 ->			
XSara Picasso 2.0i 16V	2001 ->			
			12x1,5	

33706		Aislante verde / Green colour		Reemplaza / Suitable:
<b>CITROEN</b>				<b>Citroën</b> 96.325.624
Berlingo 2.0 HDI 90 cv.	2000 ->	<b>PEUGEOT</b>		<b>PSA</b> 1338.C1
C3 1.4 HDI 16V	2002 ->	307 1.4 HDI	2001 ->	
C5 2.0 HDI	2001 ->	307 2.0 HDI 90, 110	2000 ->	
C5 2.2 HDI, Break	2001 ->	307 SW 2.0 HDI 90	2002 ->	
C8 2.2 HDI	2002 ->	406 2.0 HDI, 2.2 HDI	1999-04	
XSara 2.0 HDI, Coupe, Break	1999 ->	406 Break 2.0 HDI, 2.2 HDI	1999 ->	
XSara Picasso .0 HDI	2000 ->	406 Coupe 2.2 HDI	2000 ->	
		607 2.0 HDI, 2.2 HDI	2000 ->	
			20 mm	

NEW 33707		Aislante verde / Green colour			Reemplaza / Suitable:
<b>CITROEN</b>					<b>Citroën</b> 96.566.364
Berlingo 1.6 16V	2000 ->	<b>PEUGEOT</b>	<b>PEUGEOT Cont.</b>		<b>PSA</b> 1338.F3
C3 1.4 16V	2003 ->	1007 1.4 16V	2005 ->	207 1.6 16V Turbo	1338.F8
C3 1.6 16V	2002 ->	1007 1.6 16V	2005 ->	307 1.4 16V, Break	
C3 Pluriel 1.6	2003 ->	206 1.4 16V	2003 ->	307 1.6 16V, Break	
		206 1.6 16V	2000 ->	307 CC 1.6 16V	
		206 CC 1.6 16V	2000 ->	307 SW 1.4 16V	
		206 SW 1.4 16V	2003 ->	307 SW 1.6 16V	
		206 SW 1.6 16V	2000 ->	Partner 1.6 16V	
		207 1.4 16V	2006 ->	Ranch 1.6 16V	
		207 1.6 16V	2006 ->		
				20 mm	

33770		Aislante verde, Aro rojo / Green colour, Red ring			Reemplaza / Suitable:
<b>CITROEN</b>					<b>PSA</b> 1338.75
Xantia 3.0 i V6 24V	1996 ->	<b>PEUGEOT</b>			1338.91
		406 3.0 i V6 24V	1996 ->		
		406 Coupe 3.0 i V6 24V	1996 ->		
				12x1,5	

Motores/Engines/Moteurs: ES9J4.

33790		Aislante azul, Punto verde / Blue colour, green dot			Reemplaza / Suitable:
<b>CITROEN</b>					<b>Citroën</b> 96.335.188
Berlingo 2.0 HDI	1999-02	<b>PEUGEOT</b>			<b>Peugeot</b> 1338.C0
Jumper 2.0 HDI	2002 ->	206 2.0 HDI 90	2000 ->		
Jumper 2.2 HDI	2002 ->	306 2.0 HDI 90	1999 ->		
XSara 2.0 HDI 90	1999 ->	306 Break 2.0 HDI	1999 ->		
XSara Coupe 2.0 HDI	1999 ->	Partner 2.0 HDI	2000 ->		
XSara Break 2.0 HDI	1999 ->	Ranch 2.0 HDI	1999 ->		
				20 mm	

33791		Aislante azul / Blue colour			Reemplaza / Suitable:
<b>PEUGEOT</b>					<b>Citroën</b> 96.250.272
206	1998 ->				<b>Peugeot</b> 1338.87
306	1997 ->				
Expert	1997 ->				
Partner	1998 ->				
Ranch	1997 ->				
				14x1,25	

### IMPORTANTE:

**Al pedir accesorios eléctricos, rogamos completen la referencia comenzando por 'F' (ejemplo: 381394 → F381394)**  
*Pour commander accessoires électriques, nous vous prions de compléter la référence en commençant par 'F'.*  
 When ordering electric accessories, please complete the reference by beginning with 'F'.

## ACCESORIOS ELÉCTRICOS

## ACCESSOIRES ELECTRIQUES / ELECTRIC ACCESSORIES



SENSORES  
SENSORS  
SENSEURS

## 33792

Aislante marrón / Brown colour

CITROEN		PEUGEOT	
AX	1991-96	106	1991-96
Berlingo	1996-99	306	1993-00
Evasion	1996-02	405	1992-96
Jumper. Jumpy	1994-02	406	1996-04
Saxo	1996-00	605	1989-99
Xantia	1993-98	806	1995-02
XM	1989-00	Boxer	1994-02
XSara	1997-00	Expert	1996-02
ZX	1991-98	Partner	1996-02



Reemplaza / Suitable:  
Citroën 96.033.248  
  
Peugeot 1338.10  
1338.55



14x1,25



PTC

## 33795

Aislante azul. Punto amarillo / Blue colour, yellow dot

CITROEN		PEUGEOT	
Berlingo 1.1i, 1.4i	1996 ->	106 1.1i, 1.4i	1996 ->
Berlingo 1.6i 16V	2000 ->	106 1.6 16V	1996 ->
C3 1.1i, 1.4i	2002 ->	206 1.1i, 1.4i. SW	1998 ->
C3 16i 16V	2002 ->	206 1.6i 16V, SW, CC	2000 ->
Jumper 2.0i	2002 ->	206 2.0 HDI 90	1999 ->
Saxo 1.1i, 1.4i, 1.6i VTS	1996-02	306. Cabriolet, Break	1998 ->
Xantia 2.0 HDI 90, 109	1999-02	307 1.4, 1.6. SW	2000 ->
XSara 1.4i, 1.6i 16V, Coupe	1999 ->	406 2.0 HDI, Break	1998-04
XSara 2.0 HDI, Break, Coupe	1999 ->	Partner	1996 ->



Reemplaza / Suitable:  
Citroën 96.310.010  
96.368.027  
  
Peugeot 1338.97  
1338.A6



12x1,5



## IMPORTANTE:

Al pedir accesorios eléctricos, rogamos completen la referencia comenzando por 'F' (ejemplo: 381394 → F381394)  
Pour commander accessoires électriques, nous vous prions de compléter la référence en commençant par 'F'.  
When ordering electric accessories, please complete the reference by beginning with 'F'.



## ACCESORIOS ELÉCTRICOS

### ACCESSOIRES ELECTRIQUES / ELECTRIC ACCESSORIES

MATERIAL ELECTRICO / MATERIEL ELECTRIQUE / ELECTRIC PARTS



**TERMO-RESISTENCIA - TERMOCONTACTO**  
**THERMISTOR - THERMOCONTACT**  
**THERMISTANCE - THERMOCONTACT**

### 34050

Aislante azul, Aro amarillo / Blue colour, Yellow ring

CITROEN		CITROEN Cont.		PEUGEOT	
AX 11 TRE. 14 TZX, GT	1991-92	Xantia 1.9 D, TD	1993-94	806 2.0 i Turbo ST, SV	1994-96
AX 11 TRE Inj. Monop.	1993-93	XM 2.0, 2.0 i	1989-93		
AX 1.1 i Newline	1993-94	XM 2.0i Monopoint XT	1990-93		
AX 14 TGS Inj. Monop.	1993-93	XM 3.0 V6, 3.0 V6 24V	1990-93		
AX 1.4 i GT	1993-94	XM 2.1 Diesel	1989-93		
AX GTI 1360 cc.	1992-93	XM Turbo Diesel 2088 cc.	1990-93		
AX 14 TRD	1991-93	ZX	1991-93		
Evasion 2.0 i Turbo SX, VSX	1994-96				
Xantia 1.8 i, 2.0 i, 16V	1993-93				



Reemplaza / Suitable:  
 Citroën 96.018.422

14x1,25 118°

### 34090

Aislante azul, Aro rojo / Blue colour, Red ring

CITROEN		PEUGEOT		PEUGEOT COMM.	
Jumper 1.9 D, Turbo D	1994-96	205 1.7 D, 1.9 D	1987-94	Boxer 1.9 D, TD	1994-95
ZX 1.6 i (XU5M)	1991-93	405 1.6 i, 1.9 i. (XU)	1990-93	Boxer 2.0 (XU102C)	1994-95
ZX 1.9 i Volcane	1991-92	405 1.6 i (XU5M)	1993-95		



Reemplaza / Suitable:  
 Citroën 96.089.138  
 Fiat 9608913880  
 PSA 1338.33

14x1,25 110°

Modelos sin Aire Acondicionado.  
 Models without Air Conditioning.  
 Modèles sans Air Conditionné.

### 34110

Aislante azul, Aro gris / Blue colour, Grey ring

CITROEN		PEUGEOT		PEUGEOT Cont.	
AX (A.A.)	1994-98	106 (A.A.)	1991-98	605 (A.A.)	1990-96
Berlingo (A.A.)	1996 ->	306 (A.A.)	1993-98	806 (A.A.)	1994 ->
Evasion (A.A.)	1994 ->	405 (A.A.)	1993-96	Boxer (A.A.)	1994 ->
Jumper, Jumpy. (A.A.)	1994 ->	406 (A.A.)	1996 ->	Expert (A.A.)	1996 ->
Saxo (A.A.)	1996 ->			Partner (A.A.)	1996 ->
Xantia (A.A.)	1993-98			Ranch (A.A.)	1996 ->
XM (A.A.)	1993-96				
XSara (A.A.)	1997 ->				
ZX (A.A.)	1993-96				



Reemplaza / Suitable:  
 PSA 0242.68  
 0242.85  
 Rover Group PEJ 10007

14x1,25 115°

### 34120

Aislante azul, Aro naranja / Blue colour, Orange ring

CITROEN	
ZX 2.0 i ->PR-5837	1992-93
ZX 2.0 i 16V ->PR-5837	1992-94



Reemplaza / Suitable:  
 Citroën 96.018.427

14x1,25 140°

Temperatura de aceite.  
 Oil Temperature.  
 Température d'huile.

### 34240

Aislante azul, Aro verde / Blue colour, Green ring

CITROEN		PEUGEOT	
Evasion 2.0 i X, SX	1994-98	106 1.6 i 16V (TU5J4)	1996 ->
Evasion 2.1 Turbo D	1997 ->	306 2.0 i, 2.0 i 16V	1994-97
Saxo 1.6 i 16V VTS	1997 ->	406 2.1 Turbo D	1996 ->
Xantia 2.0 i, 2.0 i 16V	1993-99	806 2.0 i, 2.0 i Turbo	1994-98
Xantia 2.0 i Turbo	1995-98		
Xantia 1.9 SD (XUD9SD)	1997-99		
Xantia 1.9 Turbo D	1993-98		
Xantia 2.1 TD VSX	1995-99		
ZX 2.0 i, 2.0 i 16V	1994-96		



Reemplaza / Suitable:  
 Citroën 96.170.510  
 Peugeot 1131.78

14x1,25 155°

Temperatura de aceite.  
 Oil Temperature.  
 Température d'huile.

Modelos sin Aire Acondicionado.  
 Models without Air Conditioned.  
 Modèles sans Air Conditionné.

### 34250

Aislante azul, Aro negro / Blue colour, Black ring

CITROEN		PEUGEOT	
Evasion 2.0 i X, SX	1994-98	306 2.0 i, 2.0 i 16V	1994-98
Evasion 2.1 Turbo D	1997-99	405 2.0 i, MI 16	1993-95
Xantia 2.0 i, 2.0 i 16V	1995-99	406 2.1 Turbo D	1996-99
Xantia 2.0 i Turbo	1993-98	806 2.0 i, 2.0 i Turbo	1994-98
Xantia 1.9 Turbo D	1995-98		
Xantia 2.1 TD VSX	1995-98		
ZX 2.0 i PR-5838->	1994-96		
ZX 2.0 i 16V PR-5838->	1994-96		



Reemplaza / Suitable:  
 PSA 1131.80

14x1,25 155°

Temperatura de aceite.  
 Oil Temperature.  
 Température d'huile.

Modelos con Aire Acondicionado.  
 Models with Air Conditioned.  
 Modèles avec Air Conditionné.

#### IMPORTANTE:

Al pedir accesorios eléctricos, rogamos completen la referencia comenzando por 'F' (ejemplo: 381394 → F381394)  
 Pour commander accessoires électriques, nous vous prions de compléter la référence en commençant par 'F'.  
 When ordering electric accessories, please complete the reference by beginning with 'F'.

## ACCESORIOS ELÉCTRICOS

## ACCESSOIRES ELECTRIQUES / ELECTRIC ACCESSORIES

**TERMO-RESISTENCIA - TERMOCONTACTO**  
**THERMISTOR - THERMOCONTACT**  
**THERMISTANCE - THERMOCONTACT**
**34240**

Aislante azul, Aro verde / Blue colour, Green ring

CITROËN	1994-98	PEUGEOT	1996 ->
Evasion 2.0 i X, SX	1994-98	106 1.6 i 16V (TU5J4)	1996 ->
Evasion 2.1 Turbo D	1997 ->	306 2.0 i, 2.0 i 16V	1994-97
Saxo 1.6 i 16V VTS	1997 ->	406 2.1 Turbo D	1996 ->
Xantia 2.0 i, 2.0 i 16V	1993-99	806 2.0 i, 2.0 i Turbo	1994-98
Xantia 2.0 i Turbo	1995-98		
Xantia 1.9 SD (XUD9SD)	1997-99		
Xantia 1.9 Turbo D	1993-98		
Xantia 2.1 TD VSX	1995-99		
ZX 2.0 i, 2.0 i 16V	1994-96		

PEUGEOT	1996 ->
106 1.6 i 16V (TU5J4)	1996 ->
306 2.0 i, 2.0 i 16V	1994-97
406 2.1 Turbo D	1996 ->
806 2.0 i, 2.0 i Turbo	1994-98

Temperatura de aceite.  
Oil Temperature.  
Température d'huile.

Modelos sin Aire Acondicionado.  
Models without Air Conditioned.  
Modèles sans Air Conditionné.



Reemplaza / Suitable:  
Citroën 96.170.510  
Peugeot 1131.78



155 °

**34250**

Aislante azul, Aro negro / Blue colour, Black ring

CITROËN	1994-98	PEUGEOT	1994-98
Evasion 2.0 i X, SX	1994-98	306 2.0 i, 2.0 i 16V	1994-98
Evasion 2.1 Turbo D	1997-99	406 2.0 i, MI 16	1993-95
Xantia 2.0 i, 2.0 i 16V	1993-97	406 2.1 Turbo D	1996-99
Xantia 2.0 i Turbo	1995-99	806 2.0 i, 2.0 i Turbo	1994-98
Xantia 1.9 Turbo D	1993-98		
Xantia 2.1 TD VSX	1995-98		
ZX 2.0 i PR-5838->	1994-96		
ZX 2.0 i 16V PR-5838->	1994-96		

PEUGEOT	1994-98
306 2.0 i, 2.0 i 16V	1994-98
406 2.0 i, MI 16	1993-95
406 2.1 Turbo D	1996-99
806 2.0 i, 2.0 i Turbo	1994-98

Temperatura de aceite.  
Oil Temperature.  
Température d'huile.

Modelos con Aire Acondicionado.  
Models with Air Conditioned.  
Modèles avec Air Conditionné.



Reemplaza / Suitable:  
PSA 1131.80

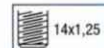

155 °

**34400**

Aislante verde, Aro naranja / Green colour, Orange ring

CITROËN	1996-99	PEUGEOT	1997-99	PEUGEOT COMM.	1994-98
Berlingo 1.9 D (D9B)	1996-99	306 1.8 D (XUD7)	1997-99	Boxer 1.9 D (XUD9)	1994-98
Xantia 1.9 D (Depol USA'87)	1993-97	306 1.9 D (XUD9)	1993-97	Partner 1.8 D (CEE 95-L3)	1996-98
ZX 1.9 D (XUD9A) N°6371->	1991-96	306 1.9 D (N5)	1997-99	Partner 1.9 D (CEE 95-L3)	1996-98
ZX 1.9 Turbo D (XUD9TE)	1992-96			Ranch 1.9 D (XUD9)	1996-98

PEUGEOT	1997-99	PEUGEOT COMM.	1994-98
306 1.8 D (XUD7)	1997-99	Boxer 1.9 D (XUD9)	1994-98
306 1.9 D (XUD9)	1993-97	Partner 1.8 D (CEE 95-L3)	1996-98
306 1.9 D (N5)	1997-99	Partner 1.9 D (CEE 95-L3)	1996-98
		Ranch 1.9 D (XUD9)	1996-98

Modelos sin Aire Acondicionado.  
Models without Air Conditioned.  
Modèles sans Air Conditionné.



Reemplaza / Suitable:  
PSA 1338.43



50 °

**34410**

Aislante verde, Aro blanco / Green colour, White ring

CITROËN	1993-96	PEUGEOT	1996-99
AX 1.5 Diesel	1993-96	106 1.5 D (CEE 95-L3)	1996-99
Saxo 1.5 D CEE 95-L3	1996-99		
XSara 1.5 Diesel (VJZ)	1997-99		

PEUGEOT	1996-99
106 1.5 D (CEE 95-L3)	1996-99

Motores/Engines/Moteurs:  
TUD5.



Reemplaza / Suitable:  
PSA 1338.50



35 °

**NEW****34425**

Aislante verde, Aro negro / Green colour, Black ring

CITROËN	1994-02	PEUGEOT	1994-02
Jumper 2.5 TD	1994-02	Boxer 2.5 TD	1994-02
Jumper 2.5 TD 4x4	1996-02	Boxer 2.5 TD 4x4	1996-02

PEUGEOT	1994-02
Boxer 2.5 TD	1994-02
Boxer 2.5 TD 4x4	1996-02

Modelos sin Aire Acondicionado.  
Models without Air Conditioned.  
Modèles sans Air Conditionné.



Reemplaza / Suitable:  
PSA 1338.42



60 °

**34430**

Aislante verde, Aro negro / Green colour, Black ring

CITROËN	1996-00	PEUGEOT	1998-00	PEUGEOT COMM.	1997-00
Berlingo 1.9 Diesel (DW8)	1996-00	206 1.9 D (DW8)	1998-00	Partner 1.9 Diesel (DW8)	1997-00
XSara 1.9 D (DW8)	1997-99			Ranch 1.9 Diesel (DW8)	1997-00

PEUGEOT	1998-00	PEUGEOT COMM.	1997-00
206 1.9 D (DW8)	1998-00	Partner 1.9 Diesel (DW8)	1997-00
		Ranch 1.9 Diesel (DW8)	1997-00

Modelos sin Aire Acondicionado.  
Models without Air Conditioned.  
Modèles sans Air Conditionné.



Reemplaza / Suitable:  
PSA 1338.85



50 °

**34435**

Aislante azul, Aro morado / Blue colour, Purple ring

CITROËN	1994-02	PEUGEOT	1996 ->
Evasion 2.0i Turbo	1994-02	406 2.0i Turbo	1996 ->
Xantia 2.0i Turbo	1995 ->	406 Break 2.0 Turbo	1997 ->
Xantia Break 2.0 Turbo	1995 ->	806 2.0i Turbo	1994-02

PEUGEOT	1996 ->
406 2.0i Turbo	1996 ->
406 Break 2.0 Turbo	1997 ->
806 2.0i Turbo	1994-02

Modelos sin Aire Acondicionado.  
Models without Air Conditioned.  
Modèles sans Air Conditionné.



Reemplaza / Suitable:  
Citroën 96.189.588  
Peugeot 1338.48



115 °

**IMPORTANTE:**

Al pedir accesorios eléctricos, rogamos completen la referencia comenzando por 'F' (ejemplo: 381394 → F381394)

Pour commander accessoires électriques, nous vous prions de compléter la référence en commençant par 'F'.

When ordering electric accessories, please complete the reference by beginning with 'F'.



## ACCESORIOS ELÉCTRICOS

### ACCESSOIRES ELECTRIQUES / ELECTRIC ACCESSORIES



MATERIAL ELECTRICO / MATERIEL ELECTRIQUE / ELECTRIC PARTS



**TERMO-RESISTENCIA - TERMOCONTACTO**  
**THERMISTOR - THERMOCONTACT**  
**THERMISTANCE - THERMOCONTACT**

### 34440

Aislante azul, Aro violeta / Blue colour, Violet ring

CITROEN		PEUGEOT		PEUGEOT COMM.	
Berlingo 1.1 i (HDY, HDZ)	1996 ->	206 1.1 i (TU1JP)	1998 ->	Partner 1.1 i (TU1M+)	1996 ->
Berlingo 1.4, 1.4 i	1996-00	206 1.4 i (TU3JP)	1998 ->	Partner 1.4 (TU3.2)	1996 ->
Saxo 1.0 i (CDZ)	1996 ->	206 1.6 i (TU5JP)	1998 ->	Partner 1.4 i (TU3JP)	1996 ->
Saxo 1.1 i (HDZ)	1996 ->	306 1.6 i (TU5JP)	1997 ->	Ranch 1.1 i (TU1M+)	1996 ->
Saxo 1.4 i (KFX)	1996 ->			Ranch 1.4 i (TU3JP)	1996 ->
Saxo 1.5 D with gauge	1996-99				
Saxo 1.6 i (NFZ)	1996 ->				
XSara 1.4 i LX, SX, (KFX)	1997 ->				
XSara 1.6 i LX, SX, Exclusive	1997 ->				

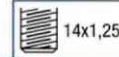
 Reemplaza / Suitable:  
 PSA 0242.83

14x1,25



117 °

### 34460

Aislante azul, Aro azul / Blue colour, Blue ring

PEUGEOT		PEUGEOT COMM.	
206 1.9 Diesel (DW8)	1998-00	Partner 1.9 Diesel (DW8)	1997-00
		Ranch 1.9 Diesel (DW8)	1997-00

 Reemplaza / Suitable:  
 PSA 1338.86

14x1,25



155 °

Modelos sin Aire Acondicionado.  
 Models without Air Conditioned.  
 Modèles sans Air Conditionné.

#### IMPORTANTE:

**Al pedir accesorios eléctricos, rogamos completen la referencia comenzando por 'F' (ejemplo: 381394 → F381394)**  
*Pour commander accessoires électriques, nous vous prions de compléter la référence en commençant par 'F'.*  
 When ordering electric accessories, please complete the reference by beginning with 'F'.



## ACCESORIOS ELÉCTRICOS

## ACCESSOIRES ELECTRIQUES / ELECTRIC ACCESSORIES



**TERMOCONTACTOS TEMPERATURA**  
**BIMETALLIC TEMPERATURE CONTACTS**  
**THERMOCONTACTS TEMPERATURE**

### 35030

**MERCEDES BENZ**  
Camiones / Trucks



Reemplaza / Suitable:  
Mercedes 004 545 55 24



### 35080

**CITROEN**  
CX 2000, CX 22000 1974-75



Reemplaza / Suitable:



### 35130

CITROEN	PEUGEOT	PEUGEOT COMM.
BX, BX 14, 1360 cc. 1983-86	104 1972-85	J 5 1.8, 2.0 1981-91
C 15 E 1124-1360 cc. 1984-87	305 1.6 GT, Diesel 1979-88	J 9 Diesel 1979-86
C 25 E 1.8, 2.0 1981-85	504, 505, Carb. 1968-91	
CX 2.0 RE, TRE, X 1979-80	505 / 604 Diesel, Turbo D 1978-87	
Mehari 1974-88		
Visa, LNA 1978-89		



Reemplaza / Suitable:

Citroën 95.493.608  
95.546.426

Peugeot 0242.33  
0242.73



### 35150

CITROEN	PEUGEOT	PEUGEOT COMM.
C 25 D 2500 1981-93	CX 2400 Pallas 1976-89	J 5 Diesel 1981-93
C 25 D 2500 Turbo 1983-93	CX 2400 Prestige 1980-83	
CX 2000 1985 cc. 1975-85	CX 2400 GTI, Injection 1977-84	
CX 2.0 RE, TRE, X 1981-89	CX 25 IE, GTI, RI, TRI 1983-85	
CX 2.0 Athena, Reflex 1981-89	CX 25 GTI Turbo, Turbo 2 1984-85	
CX 2200 2175 cc. 1975-76	CX 25 Diesel 1978-85	
CX 2.2 RS, TRS 1986-89	CX 25 DI Turbo, Turbo 2 1983-85	
CX 2200 Diesel 1976-79		



Reemplaza / Suitable:

Citroën 5.452.407  
75.465.759  
75.490.468

Peugeot 0242.45



### 35170

CITROEN	PEUGEOT	TALBOT
BX 15, BX 16, BX 19 1983-93	205 1.6 GTI 1984-93	Horizon 1.9 Diesel 1982-86
BX 19 Diesel, Turbo D 1983-93	205 Diesel 1983-87	Solara Diesel 1980-84
C 15 D 1769 cc. 1984-89	305 1.6 GT, 1.9 GTX 1983-88	
C 25 D 1905 cc. 1988-93	309 1986-93	
Visa 1.6 GTI 1985-89	405 Diesel, Turbo D 1988-93	
Visa Diesel 1984-89	504 V6, Cabriolet, Coupé 1974-82	
	505 GTI, STI, Injection 1984-91	
	505 GLD, GRD, SRD 1987-91	
	604 V6 2.7 1975-86	



Reemplaza / Suitable:

Citroën 95.495.591  
95.579.683

Ford 1645282

Peugeot 0242.30  
0242.39  
0242.43  
91 50 094 680

Talbot 95 579 683 80



### 35180

CITROEN	PEUGEOT	TALBOT
AX Gasolina/Petrol 1987-90	205 1983-93	Horizon GLS 5 veloc. 1982-86
BX, BX 14, 1360 cc. 1986-91	305 13, 1.5 1977-82	Horizon Automatic 1982-86
BX 16, BX 19 1983-93	309 1.6, 1.9, 1.9 GTI 1986-93	
BX 19 GTI, 16V, 4x4 1986-93	309 1.7, 1.9 Diesel 1988-93	
BX D, BX 17 D 1986-93	405 Gasolina/Petrol 1987-93	
BX 19 Diesel, Turbo D 1983-93	405 1.4 i, 1.6 i 1993-95	
C 15 E 1987-94	405 1.9 D, Turbo D 1993-95	
C 15 D 1.1 i, 1.4 i 1995-98	505 1979-91	
C 15 D 1769 cc. 1990-98	604 V6 2.7 1975-86	



Reemplaza / Suitable:

Citroën 91.519.272  
95.495.592  
95.579.684

Ford 6198827

Peugeot 0242.26  
0242.49  
0242.51

Talbot 91 51 927 280



### 35190

PEUGEOT	PEUGEOT COMM.
505 GLD, GRD, SRD 1982-91	J 9 Diesel 1979-86
505 Turbo D 2.5 1983-91	



Reemplaza / Suitable:

Peugeot 1131.11



Temperatura de aceite.  
Oil temperature.  
Température d'huile.

### IMPORTANTE:

Al pedir accesorios eléctricos, rogamos completen la referencia comenzando por 'F' (ejemplo: 381394 → F381394)  
Pour commander accessoires électriques, nous vous prions de compléter la référence en commençant par 'F'.  
When ordering electric accessories, please complete the reference by beginning with 'F'.

**ACCESORIOS ELÉCTRICOS**
**ACCESSOIRES ELECTRIQUES / ELECTRIC ACCESSORIES**

<b>TERMOCONTACTOS TEMPERATURA</b> <b>BIMETALLIC TEMPERATURE CONTACTS</b> <b>THERMOCONTACTS TEMPERATURE</b>			
<b>35200</b>			
<b>PEUGEOT</b> 604 V6 2.7      1975-86	6,35 mm		<b>Reemplaza / Suitable:</b> Peugeot 0242.32 Renault 77 00 704 046 77 00 768 589
		14x1,25	115°
<b>35210</b>			
<b>PEUGEOT</b> 504 Diesel      1979-86 505 GLD, GRD, SRD      1979-82	6,35 mm		<b>Reemplaza / Suitable:</b> Ford 6065385 Peugeot 0242.25 0242.41 79 32 568 137 R.V.I. 0024441800 5000785738
		18x1,5	97°
<b>35220</b>			
<b>PEUGEOT</b> 304 Diesel      1976-80 404 Diesel      1962-75 504 Diesel      1968-79 J 9 Diesel      1986-91	6,35 mm		<b>Reemplaza / Suitable:</b> Peugeot 0242.24
		18x1,5	93°
<b>35230</b>			
<b>CITROEN</b> Visa Diesel      1984-89	<b>PEUGEOT</b> 205 Diesel      1983-87 305 1.6 Diesel      1984-88 305 Diesel 1.7, 1.9      1984-88 309 Diesel 1.7, 1.9      1986-88	<b>TALBOT</b> Horizon 1.9 Diesel      1982-86	4 mm Temperatura de aceite. Oil temperature. Température d'huile. Cable 750 mm.
		16x1,5	140°
<b>35260</b>			
<b>CITROEN</b> AX Diesel 1360 cc.      1989-91	<b>PEUGEOT</b> 205 1.7 Turbo Diesel      1991-94 309 1.7 Turbo Diesel      1990-93 405 1.7 Diesel      1991-93 405 1.7 Turbo Diesel      1988-93 405 1.9 Diesel      1990-93	6,35 mm	
		14x1,25	118°
<b>35290</b>			
<b>CITROEN</b> AX 11 E, TE      1991-92 AX 14 TGS Premier      1991-92 AX 11 TE Inj. Monop.      1993-97 AX 14 D, TD      1992-97 AX 15 D, TD      1994-97 Saxo 1.5 Diesel      1997-99 XM 2.0 (-> PR-4871)      1989-90 ZX 1.4, 1.4i      1991-93 ZX 1.9 D, 1.9 Turbo D      1991-96	Aislante azul. Aro verde o amarillo / Blue colour, Green or Yellow ring <b>PEUGEOT</b> 106 0.9, 1.1, 1.3, Carb.      1992-96 106 0.9 i, 1.1 i, 1.3 i, 1.4 i      1992-98 106 1.3 Diesel (TUD3)      1991-96 106 1.5 Diesel (TUD5)      1994-98 106 1.6 i 90 cv. (TU5JP)      1996-00 106 1.6 i 16V (TU5J4)      1996-00	6,35 mm	
		14x1,25	118°
<b>35295</b>			
<b>CITROEN</b> Jumper 2.5 DT Combi      1994-97 Jumper 2.5 DTi (230L/P)      1997-00 Jumper 2.5 TDI, 4x4      1996-00 Jumper 2.5 TDI (230)      2000-02 Jumper TDI 4x4 (230)      2000-02	Aislante blanco. Aro violeta / White colour, Violet ring <b>PEUGEOT</b> 605 2.1 D (XUD11A)      1989-95 605 2.1 Turbo Diesel      1994-99 605 Diesel Depol EGR      1990-97	6,35 mm	
		14x1,25	30°

**IMPORTANTE:**

**Al pedir accesorios eléctricos, rogamos completen la referencia comenzando por 'F' (ejemplo: 381394 → F381394)**  
*Pour commander accessoires électriques, nous vous prions de compléter la référence en commençant par 'F'.*  
 When ordering electric accessories, please complete the reference by beginning with 'F'.



## ACCESORIOS ELÉCTRICOS

## ACCESSOIRES ELECTRIQUES / ELECTRIC ACCESSORIES

**TERMOCONTACTOS TEMPERATURA**  
**BIMETALLIC TEMPERATURE CONTACTS**  
**THERMOCONTACTS TEMPERATURE**
**35550**

Aislante negro, Aro violeta / Black colour, Violet ring

CITROËN		PEUGEOT	
Evasion 1.9 TD Depol.	1994-98	306 1.7 D (XAD)	1994-97
Xantia Gasolina/Petrol	1993-97	306 1.9 D (XUD9A)	1993-97
Xantia 1.8 i 16V (XU7JP4)	1997-00	605 2.0 i (XU10J2)	1990-94
Xantia 2.0 i Turbo CT	1995-00	605 2.1D, Turbo D	1990-94
Xantia 3.0 i V6 (ES9J4)	1997-00	605 3.0 i V6, V6 24V	1990-94
XM	1989-96	806 1.9 Turbo D	1995-98
XSara	1997-00		
ZX	1992-96		

Modelos sin Aire Acondicionado.  
 Models without Air Conditioned.  
 Modèles sans Air Conditionné.



Reemplaza / Suitable:  
 Citroën 96.092.918  
 PSA 0242.76



14x1,25



50 °

**35600**

Aislante azul, Aro violeta / Blue colour, Violet ring

CITROËN		PEUGEOT	
Xantia 1.9 Turbo D	1993-98	Boxer 2.5 D (DJ5)	1994-95
<b>CITROËN COMM.</b>		Boxer 2.5 Turbo D (DJ5T)	1994-95
Jumper 2.5 D (DJ5)	1994-98	Boxer 2.5 Turbo D (DJ5TED)	1996-99
Jumper 2.5 Turbo D (DJ5T)	1994-97		
Jumper 2.5 TD (DJ5TED)	1997-99		

Modelos sin Aire Acondicionado.  
 Models without Air Conditioned.  
 Modèles sans Air Conditionné.



Reemplaza / Suitable:  
 PSA 1338.40



14x1,25



113 °

**35610**

Aislante verde, Aro violeta / Green colour, Violet ring

CITROËN		PEUGEOT		PEUGEOT COMM.	
Evasion 1.9 Turbo D	1995-98	306 1.9 Turbo D	1993-98	806 1.9 Turbo D	1995-99
Jumper 1.9 Turbo D	1994-98	405 1.9 Turbo D	1993-95	Boxer 1.9 D (XUD9AU)	1994-95
Jumper 2.5 D, Turbo D	1994-98	406 1.9 SD (XUD9SD)	1997-99	Boxer 1.9 Turbo D (XUD9TF)	1994-95
Jumpy 1.9 Turbo D	1995-98	406 1.9 Turbo D	1996-99	Boxer 2.5 D (DJ5)	1995-99
Saxo 1.5 Diesel	1997-99	406 2.1 Turbo D	1996-99	Boxer 2.5 Turbo D (DJ5T)	1995-99
Xantia 1.9 SD (XUD9SD)	1997-99			Expert 1.9 TD (XUD9TE)	1996-99
Xantia 1.9 Turbo D	1993-98				
XSara 1.9 Turbo D	1997-99				
ZX 1.9 Turbo D	1992-96				



Reemplaza / Suitable:  
 Citroën 96.142.336  
 PSA 1338.27



14x1,25



60 °

**IMPORTANTE:**

Al pedir accesorios eléctricos, rogamos completen la referencia comenzando por 'F' (ejemplo: 381394 → F381394)

Pour commander accessoires électriques, nous vous prions de compléter la référence en commençant par 'F'.

When ordering electric accessories, please complete the reference by beginning with 'F'.

## ACCESORIOS ELÉCTRICOS

### ACCESSOIRES ELECTRIQUES / ELECTRIC ACCESSORIES



#### TERMOCONTACTOS VENTILADOR BIMETALLIC TEMPERATURE CONTACTS FOR FAN THERMOCONTACTS POUR VENTILATEUR

**36650**

Aislante marrón, Aro blanco / Brown colour, White ring

CITROËN		PEUGEOT	
XM 2.1 Diesel (XUD11A)	1995-99	605 2.1 TD (XUD11ATE)	1995-99
XM 2.1 Turbo D (XUD11ATE)	1995-99	605 Automatics	1995-99
XM Automatics	1995-99		

Situado en la caja de cambios.  
Fan switch fitted on automatic gear.  
Placé dans la boîte de vitesses.

**Reemplaza / Suitable:**  
 Citroën 96.128.754  
 PSA 1264.29

**37220**

Aislante negro / Black colour

CITROËN		PEUGEOT	
Jumper 2.0 i (XU10J2U)	1994-98	Boxer 1.9 D (XUD9AU)	1995-98
		Boxer 1.9 Turbo D	1995-98
		Boxer 2.0 (XU10ZC)	1994-98
		Boxer 2.0 i (XU10ZJC)	1994-98
		Boxer 2.5 D (DJ5)	1995-98
		Boxer 2.5 TD (DJ5T)	1995-98

Modelos sin Aire Acondicionado.  
Models without Air Conditioned.  
Modèles sans Air Conditionné.

**Reemplaza / Suitable:**  
 PSA 1264.32

**37310**

Aislante negro / Black colour

CITROËN	
AX 10, AX 11, AX 14	1987-89
BX, BX 14 1360 cc.	1986-91
C 15 E 1124-1360 cc.	1988-94
CX	1979-89

**37010**

Aislante blanco / White colour

**Reemplaza / Suitable:**  
 Citroën 96.029.641

**37320**

Aislante negro / Black colour

CITROËN		PEUGEOT	
ID, DS	1967-75	305 1.3, 1.5	1983-87
SM	1970-74	305 1.6 Diesel	1979-83
		504 Diesel	1982-83
		505 GLD, GRD, SRD	1982-86
		505 Turbo Diesel 2.5	1983-86
		604 V6 2.7	1975-86
		604 TI, V6 Injection	1977-86
		604 Diesel, Turbo Diesel	1984-87

**37020**

Aislante blanco / White colour

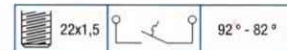
**Reemplaza / Suitable:**  
 Citroën 5.418.467  
 Peugeot 1264.05  
 1264.06  
 1264.09  
 1264.12  
 1264.15

#### IMPORTANTE:

Al pedir accesorios eléctricos, rogamos completen la referencia comenzando por 'F' (ejemplo: 381394 → F381394)  
 Pour commander accessoires électriques, nous vous prions de compléter la référence en commençant par 'F'.  
 When ordering electric accessories, please complete the reference by beginning with 'F'.



ACCESORIOS ELÉCTRICOS

ACCESSOIRES ELECTRIQUES / ELECTRIC ACCESSORIES



**TERMOCONTACTOS VENTILADOR**  
**BIMETALLIC TEMPERATURE CONTACTS FOR FAN**  
**THERMOCONTACTS POUR VENTILATEUR**

**37330**

Aislante negro / Black colour

CITROEN	
AX 10, AX 11, AX 14	1987-89
AX GT, AX Sport	1987-89
PEUGEOT	
205 1118-1294 cc. (F)	1988-89
309 1.6, 1.9	1986-90

TALBOT-SIMCA	
Horizon GL, LS. 1.1, 1.3	1978-86
Horizon GLS 1442-1592	1978-86
Horizon 1.9 Diesel	1982-86
Matra Bagheera	1973-80
Matra Rancho	1977-84
Matra 530 LX	1970-80
Murena 1600, 2200	1980-84
Simca 900, Special. (E)	1970-76
Simca 1000	1974-78
Simca 1000 Rallye	1970-78
Simca 1100 (F)	1972-81
Simca 1200 (E)	1969-82
Simca 1307, 1308	1975-86
Simca 1309 SX	1978-86
Simca 1510	1979-86
Solara LS, GLS	1980-84
Solara GLS, SX	1980-84
Solara Escorial 1.6	1985-88
Solara Diesel	1980-84
Tagora GL, GLS	1981-84

**37030**

Aislante blanco / White colour

TALBOT (GB)	
Alpine	1975-84
Horizon 1.1, 1.3, 1.5	1978-86
Minx, Rapier 1.6	1984-86
Rancho 1.5	1978-84
Solara 1.3, 1.6, SX	1980-84
Tagora 2.2 GL, GLS	1981-84
180, 2 l	1972-81

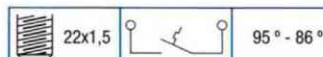

**Reemplaza / Suitable:**

Citroën	5.435.033
	95.632.734
Peugeot	1264.20
Talbot	0012812300
	0013255100
	0013265100
	30184 M
	SG-18145000

**37340**

Aislante negro / Black colour

CITROEN	
BX, BX 14	1983-86
C 15 E 1124-1360 cc.	1984-87
CX 2400	1975-80
CX 2.0 RE, TRE, Reflex, X	1979-80
CX 2200 Diesel	1976-79
LNA 11 E, RS	1982-86
Visa Super, 11 E, RE	1978-89
Visa 14 TRS, Stilo	1982-89
PEUGEOT	
104	1972-85
205	1983-87
304, 304 Diesel	1976-80
305	1977-88
309 1.1, 1.3, 1.5	1986-90
505	1979-91
505 Diesel, Turbo D	1982-86
604 Diesel, Turbo Diesel	1981-84
J 9 Diesel	1979-86

TALBOT-SIMCA	
Samba	1981-86
Simca 1300, 1301, S	1970-75
Simca 1500, 1501, S	1970-75
TALBOT-CHRYSLER	
160, 180, 1610	1970-78

**37040**

Aislante blanco / White colour

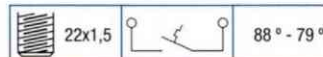

**Reemplaza / Suitable:**

Citroën	91.514.046
	91.515.141
	95.543.583
	95.611.529
Peugeot	1264.03
	1264.14
Renault	77 00 268 560
	77 00 613 658
	77 00 622 754
	77 00 634 517
	77 00 640 353
	77 00 646 484
	77 01 348 194
	77 01 349 765
R.V.I.	5000785737
Talbot	0055289100
	30775 C
	7710 010 888

**37350**

Aislante negro / Black colour

PEUGEOT	
204, 204 Diesel	1966-77
304 1.1, 1.3	1969-75
304 Diesel	1969-75
404, 404 Diesel	1960-75
504 1.8, 2.0	1968-82
504 Injection	1968-82
504 V6, Cabriolet, Coupé	1974-82
504 Diesel	1968-83
505 GLD, GRD, SRD	1979-82

PEUGEOT COMM.	
J 7 Gasolina / Petrol	1965-79
J 7 Diesel	1968 ->
J 9 Gasolina / Petrol	1979 ->

**37050**

Aislante blanco / White colour

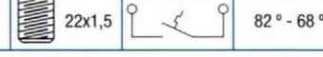

**Reemplaza / Suitable:**

Peugeot	0242.10
	0242.12

**37390**

Aislante negro / Black colour

CITROEN	
CX 2000	1975-78
CX 2200	1975-76
CX 2.0, 2.2	1975-85
LNA 11 RE	1982-84
Visa Super, Super E	1978-81
Visa Crono 1.3	1982-87
Visa II	1984-89
Visa GT	1982-89
Visa 11	1984-89

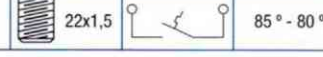

**Reemplaza / Suitable:**

Citroën	95.493.258
---------	------------

**IMPORTANTE:**

Al pedir accesorios eléctricos, rogamos completen la referencia comenzando por 'F' (ejemplo: 381394 → F381394)

Pour commander accessoires électriques, nous vous prions de compléter la référence en commençant par 'F'.

When ordering electric accessories, please complete the reference by beginning with 'F'.

**ACCESORIOS ELÉCTRICOS**
**ACCESSOIRES ELECTRIQUES / ELECTRIC ACCESSORIES**

**TERMOCONTACTOS VENTILADOR  
BIMETALLIC TEMPERATURE CONTACTS FOR FAN  
THERMOCONTACTS POUR VENTILATEUR**
**37400** Aislante negro / Black colour

CITROEN		PEUGEOT	
AX 10, AX 11, AX 14	1989-91	205 GL, GR, GT, GTX. (E)	1987-88
AX GT, AX Sport	1989-91	405 1.6, 1.9	1987-88
AX 14 Diesel ->PR-4859	1989-90	405 Turbo Diesel	1988-89
CX 2200 Diesel	1976-79		
CX 2400 Pallas	1976-89		
CX 2400 GTI, Injection	1980-84		
CX 25 Diesel	1978-85		
CX 25 DI Turbo, Turbo 2	1983-85		

6,35 mm

**Reemplaza / Suitable:**

<b>Citroën</b>	5.463.397 5.490.542 95.492.854 96.015.494
<b>Peugeot</b>	1264.21

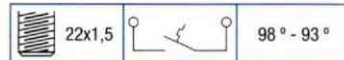
**37420**

Aislante negro / Black colour

PEUGEOT		TALBOT	
305 1.9 GTX	1985-88	Camiones / Trucks	
305 1.6 Diesel	1979-83		
604 Diesel	1978-81		
604 Turbo D, GRD, SRD	1978-81		

6,35 mm

**Reemplaza / Suitable:**

<b>Peugeot</b>	1264.04, 13
<b>R.V.I.</b>	26171030
<b>Talbot</b>	91 513 810 80

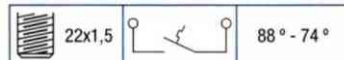
**37570**

Aislante azul, Aro blanco / Blue colour, White ring

CITROEN		PEUGEOT	
XM 2.0, 2.0 i	1989-94	205 Motores/Engines TU	1989-93
XM 2.0 i Monopoint XT	1990-94	205 1.6 GTI, 1.9 GTI	1989-93
XM 3.0 V6, 3.0 V6 24 V	1990-94	309 Motores/Engines TU	1990-93
		309 1.6, 1.9, (XU)	1990-93
		309 1.6 i, 1.9 i, 1.9 i 16V	1990-93
		309 Diesel	1990-93
		405 GL, GR, SR, 1.6, 1.9	1987-93
		405 1.9 GRI, SRI	1987-93
		405 Diesel, Turbo D	1987-93

**Reemplaza / Suitable:**

<b>Citroën</b>	96.009.503
<b>Peugeot</b>	1264.23



**37580**

Aislante azul, Aro amarillo / Blue colour, Yellow ring

CITROEN		CITROEN COMM.		PEUGEOT	
AX 11, AX 14, AX GTI	1991-98	Berlingo 1.1 i, 1.4 i, 1.8 i	1996 ->	106	1991-98
AX 14 D (PR.4860-5117)	1990-91	Jumpy 1580 SPI	1995-98	205	1989-93
Evasion 1.8 i, 2.0 i X, SX	1994-98			306	1993 ->
Saxo	1996 ->			309 1.1 i, 1.3 i, 1.7 TD	1989-93
Xantia except Diesel	1993-97			405 Gasolina / Petrol	1990-93
XSara	1997 ->			406 1.6 i, 1.8 i, 16V	1996 ->
XM 2.1 Diesel	1989-91			806 1.8 i, 2.0 i, 16V	1994 ->
ZX Gasolina / Petrol	1991-96			Expert Gasolina / Petrol	1996 ->
ZX 1.9 Diesel	1991-92			Partner Gasolina / Petrol	1996 ->

**Reemplaza / Suitable:**

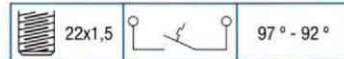
<b>Citroën</b>	96.064.561
<b>Peugeot</b>	1264.26
<b>PSA</b>	1264.37

**37680**

Aislante azul, Aro verde / Blue colour, Green ring

CITROEN		PEUGEOT	
AX 14 Diesel	1991-97	306 1.7 D (XAD)	1994-97
Berlingo 1.9 D (XUD9)	1996-99	306 1.9 D (XUD9A)	1993-97
Xantia 1.8 i 16V, 2.0 i 16V	1995-99	406 1.9 TD, 2.1 Td	1996-99
Xantia 1.9 Turbo D	1996-99	Partner 1.7 D, 1.9 D	1998-00
ZX 1.9 Diesel	1992-97	Ranch 1.7 D, 1.9 D	1996-99

Modelos sin Aire Acondicionado.  
Models without Air Conditioned.  
Modèles sans Air Conditionné.

Sustituye original aro verde (naranja versión antigua).  
Replaces original green ring (orange old version).  
Replace original bague vert (orange ancienne version).

**Reemplaza / Suitable:**

<b>Citroën</b>	93.123.564 93.138.637
<b>Peugeot</b>	1264.31

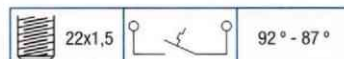
**IMPORTANTE:**

Al pedir accesorios eléctricos, rogamos completen la referencia comenzando por 'F' (ejemplo: 381394 → F381394)  
 Pour commander accessoires électriques, nous vous prions de compléter la référence en commençant par 'F'.  
 When ordering electric accessories, please complete the reference by beginning with 'F'.



## ACCESORIOS ELÉCTRICOS

## ACCESSOIRES ELECTRIQUES / ELECTRIC ACCESSORIES

FAE



TERMOCONTACTOS 2 VENTILADORES/VELOCIDADES  
THERMO-SWITCHES 2 FANS/SPEEDS  
THERMOCONTACTS 2 VENTILATEURS/VITESSES

## 37800

CITROËN		PEUGEOT	
BX 16, BX 19	1983-93	305 1.3, 1.5	1983-87
BX 19 GTI	1986-93	305 1.6 GT	1983-88
BX 19 Diesel, Turbo D	1983-89	305 Diesel 1.7, 1.9	1979-88
C 15 D 1769 cc.	1993-96	309 1.6, 1.9	1986-87
CX 2.0, 2.2	1985-89	309 Diesel 1.7, 1.9	1986-87
CX 2.5 IE, GTI, TRI, RI	1985-89	505 GTI, STI, Injection	1984-87
CX 2.5 GTI Turbo, Turbo 2	1985-89	505 Turbo	1986-91
CX 2.5 Diesel, DI Turbo	1985-89	505 Diesel, Turbo D	1986-91
Visa Diesel	1984-86	604 Turbo D, GRD, SRD	1984-87



Reemplaza / Suitable:

Citroën 95.495.385  
95.576.325  
95.612.640  
Peugeot 1264.17



22x1,5



88 ° - 83 °

92 ° - 87 °

## 37810

CITROËN		PEUGEOT	
C 15 D	1984-89	205 1.1, 1.4, 1.4 GT. (F)	1987-88
Visa 1.6 GTI	1985-89	205 1.0, 1.2, 1.3, 1.4. (TU)	1988-89
Visa Diesel	1986-88	205 1.6 GTI	1984-87
		205 GTX (E)	1986-89
		205 1.6 GTX (F)	1987-89
		205 Diesel	1983-87
		305 1.6 Diesel	1984-88
		504 Diesel	1979-83



Reemplaza / Suitable:

Alfa Romeo 60533503  
Citroën 95.516.467  
95.630.939  
Peugeot 1264.16



22x1,5



84 ° - 79 °

88 ° - 83 °

## 37850

CITROËN		PEUGEOT	
BX 19 GTI 16V	1988-93	205 1.6 GTI	1987-89
BX 17 D	1986-93	205 Diesel	1983-87
BX 19 Diesel	1989-93	305 1.9 GTX	1985-88
BX TRD Turbo Diesel	1989-93	305 Diesel 1.7, 1.9	1984-88
C 15 E 1118-1294 cc.	1987-88	309 1.6, 1.9	1987-90
C 15 Diesel	1990-92	309 Diesel 1.7, 1.9	1987-90
Visa Diesel	1988-89	405	1987-90
		405 1.9 Turbo Diesel	1988-90
		505 GTI, STI, Injection	1987-88



Reemplaza / Suitable:

Citroën 91.517.674  
96.019.305  
Peugeot 1264.18



22x1,5



93 ° - 88 °

97 ° - 92 °

## 37860

PEUGEOT	
205 A. A.	1987-90
205 Rallye	1988-90
309 1.9 GTI	1987-90
405 1.7 D, 1.9 D, 1.9 TD	1988-90
505 GTI, STI, Injection	1987-90
505 GLD, GRD, SRD	1987-90



Reemplaza / Suitable:

Peugeot 1264.22  
Renault 60 01 008 060



22x1,5



97 ° - 92 °

101 ° - 96 °

## 37890

CITROËN		PEUGEOT COMM.	
C 25 D 1905	1987-92	J 5 1905 Diesel	1988-93
C 25 D 2500	1981-92	J 5 2.5 D, 2.5 TD	1981-93
C 25 Turbo D 2500	1983-92		



Reemplaza / Suitable:

Citroën ZF-05.934.064

Peugeot 1264.10



22x1,5



88 ° - 83 °

92 ° - 87 °

Cable 160 mm.

## IMPORTANTE:

Al pedir accesorios eléctricos, rogamos completen la referencia comenzando por 'F' (ejemplo: 381394 → F381394)

Pour commander accessoires électriques, nous vous prions de compléter la référence en commençant par 'F'.

When ordering electric accessories, please complete the reference by beginning with 'F'.

## ACCESORIOS ELÉCTRICOS

### ACCESSOIRES ELECTRIQUES / ELECTRIC ACCESSORIES



MATERIAL ELECTRICO / MATERIEL ELECTRIQUE / ELECTRIC PARTS



#### TERMOCONTACTOS 2 VENTILADORES/VELOCIDADES

#### THERMO-SWITCHES 2 FANS/SPEEDS

#### THERMOCONTACTS 2 VENTILATEURS/VITESSES

### 37900

Aislante negro / Black colour

CITROEN		PEUGEOT	
Jumper 1.9 D (XUD9AU)	1994-98	Boxer 1.9 D (XUD9AU)	1994-95
Jumper 1.9 TD (XUD9UTF)	1994-98	Boxer 1.9 TD (XUD9UTF)	1994-95
Jumper 2.5 D (DJ5)	1994-98	Boxer 2.5 D (DJ5)	1994-95
Jumper 2.5 TD (DJ5T)	1994-98	Boxer 2.5 Turbo D (DJ5T)	1994-95
		Boxer 2.5 Turbo D (DJ5TED)	1995-98

**Reemplaza / Suitable:**  
 PSA 1264.34

22x1,5

 88 ° - 83 °  
 92 ° - 87 °

### 37910

Aislante azul / Blue colour

CITROEN		PEUGEOT	
Jumper 2.0 i (A. A.)	1994-98	Boxer 2.0 i (A. A.)	1994-98

**Reemplaza / Suitable:**  
 PSA 1264.33

22x1,5

 92 ° - 87 °  
 97 ° - 92 °

### 37920

Aislante azul, Aro gris / Blue colour, Grey ring

CITROEN		PEUGEOT	
AX GTI	1991-96	106	1991-98
Evasion 1.9 TD, 2.1 TD	1995-98	205	1989-93
Jumpy 1.9 D, TD	1995-98	306	1993-99
Xantia	1993-99	309	1990-93
XM	1989-94	405	1993-96
XSara	1997-99	605	1990-98
ZX	1991-96	806 1.9 TD, 2.1 TD	1995-99
		Expert 1.9 D, TD	1996-99

**Reemplaza / Suitable:**  
 Citroën 95.638.684  
 Peugeot 1264.24  
 PSA 1264.44

Sustituye también aro violeta.  
 Replaces also violet ring.  
 Remplace aussi bague violette.  
 Modelos con Aire Acondicionado.  
 Models with Air Conditioned.  
 Modèles avec Air Conditionné.

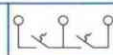

22x1,5

 92 ° - 87 °  
 97 ° - 92 °

### 37930

Aislante azul, Aro rojo / Blue colour, Red ring

CITROEN		PEUGEOT COMM.		PEUGEOT	
AX 15 D, TD	1994-98	Expert 1.9 TD	1996-99	106	1996-99
Berlingo 1.8 D, 1.9 D	1996-98	Partner 1.7 D, 1.9 D	1996-97	205	1990-93
Evasion 2.0 i Turbo	1994-98	Ranch 1.7 D, 1.9 D	1996-99	206 1.9 Diesel (DWB)	1998-00
Saxo Diesel	1997-99			306	1993-98
Saxo 1.6 i 16V VTS	1997-99			309	1990-93
Xantia	1993-99			405	1990-96
XSara 1.8 i Exclusive	1997-99			406	1996-99
XM	1992-96			605	1990-98
ZX	1993-96			806 2.0 i Turbo	1994-98

**Reemplaza / Suitable:**  
 Citroën 96.064.750  
 Peugeot 1264.25  
 PSA 1264.38  
 1264.45

22x1,5

 97 ° - 92 °  
 101 ° - 96 °

### 37935

Aislante azul / Blue colour

CITROEN		PEUGEOT	
Xantia	1993 ->	205	1990-93
XM	1989 ->	306	1993 ->
XSara	1989 ->	309	1990-93
ZX	1989 ->	405	1993-96
		605	1990 ->

**Reemplaza / Suitable:**

Países Cálidos.  
 Hot countries.  
 Pays chauds.



22x1,5

 74 ° - 69 °  
 78 ° - 73 °

### 37940

Aislante azul, Aro negro / Blue colour, Black ring

CITROEN		PEUGEOT	
Xantia	1993-97	205	1990-93
XM	1989-96	306	1993-97
XM 3.0 i V6 (A.A.)	1989-96	309	1990-93
XM 3.0 i V6 24V (A.A.)	1989-96	405	1993-96
XSara (A.A.)	1997-00	605	1990-97
ZX	1991-96		

**Reemplaza / Suitable:**  
 Citroën 96.085.909  
 Peugeot 1264.27

Cambio Automático (CVA).  
 Automatic gear box (CVA).  
 Boîte de vitesses Automatique (CVA).

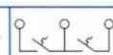

22x1,5

 84 ° - 79 °  
 88 ° - 83 °

#### IMPORTANTE:

Al pedir accesorios eléctricos, rogamos completen la referencia comenzando por 'F' (ejemplo: 381394 → F381394)

*Pour commander accessoires électriques, nous vous prions de compléter la référence en commençant par 'F'.*

When ordering electric accessories, please complete the reference by beginning with 'F'.



ACCESORIOS ELÉCTRICOS

ACCESSOIRES ELECTRIQUES / ELECTRIC ACCESSORIES



**INTERRUPTORES DE LUZ MARCHA ATRAS  
REVERSING LIGHT SWITCHES  
CONTACTEURS DE PHARE DE REcul**



**INTERRUPTORES DE LUZ MARCHA ATRAS  
REVERSING LIGHT SWITCHES  
CONTACTEURS DE PHARE DE REcul**

**ACCESORIOS ELÉCTRICOS**
**ACCESSOIRES ELECTRIQUES / ELECTRIC ACCESSORIES**

**INTERRUPTORES DE LUZ MARCHA ATRAS  
REVERSING LIGHT SWITCHES  
CONTACTEURS DE PHARE DE RECU**
**40130**

TALBOT - SIMCA		TALBOT - CHRYSLER	
Horizon 1.1, 1.3	1978-86	150	1977-81
Horizon GLS 1442-1592	1978-86		
Simca 1100 (F)	1972-74		
Simca 1200 GL, GLE. (E)	1969-74		
Simca 1200 S (E)	1973-76		
Simca 1200 (E)	1974-80		
Simca 1307, 1308	1975-79		
Solara LS, GLS	1980-84		
Solara Diesel	1980-84		

Modelos con 4 velocidades.  
Models with 4 speeds.  
Modèles avec 4 vitesses.



Reemplaza / Suitable:  
Talbot 0014159500  
78178030



**40160**

TALBOT-DODGE	
Dodge Dart	1965-71
Dodge 3700, 3700 GT	1971-77

Cambio Fuller RTO 9509

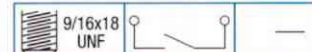

Reemplaza / Suitable:  
Pegaso 620.866  
621.220  
Talbot 4092258404  
LB-78178000

**40270**

PEUGEOT		PEUGEOT COMM.		TALBOT	
204	1970-76	304 Van	1976-81	Murena 2200	1980-84
304, 304 Diesel	1969-80	305 Van 1.5	1980-84	Tagora GL, GLS, 2156 cc.	1981-84
305 1.3, 1.5, Diesel	1977-83	J 7	1965-79	Tagora SX 2664 cc.	1982-84
404, 404 Diesel	1966-75	J 9 Gasolina / Petrol	1979 ->	Tagora Turbo Diesel	1982-84
504, 504 Diesel	1968-83	J 9 Diesel	1979-86	<b>TALBOT (GB)</b>	
505, 505 Diesel	1979-91			Tagora 2.2 GL, GLS	1981-84
505 Turbo Diesel 2.5	1983-91			Tagora 2.6 SX (V6)	1981-84
604 V6 2.7, V6 Injection	1975-86				
604 Diesel, Turbo D	1978-87				

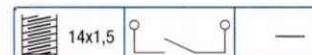

Reemplaza / Suitable:  
Peugeot 2257.12  
Suzuki 37610A80042  
37610-80042  
Talbot 7910002503

**40340**

CITROËN	
GS, GS Club, GSX	1971-81
GSA, GSAX	1980-86
LNA 652 cc.	1982-86
Visa, Visa II, 652 cc.	1978-85



Reemplaza / Suitable:  
Citroën 75.503.370,377  
94.491.301  
95.494.194  
95.649.419  
GX-0192601-A  
GX-0926001-A  
Seat 3928922  
SE-127952500A



**40491**

Aislante gris / Grey colour

CITROËN		PEUGEOT		PEUGEOT Cont.	
Berlingo	1996 ->	106 II	1996 ->	306, 306 Break, Cabrio	1994 ->
C3 1.4i 16V HDI	2002 ->	206	1999 ->	307, 307 StationWagon	2000 ->
C5, C5 Break	2001 ->			406, 406 Coupe, Break	1996 ->
C8 2.0i 16V (RFN)	2002 ->			607	2000 ->
Evasion 1.8i, 2.0i, 16V	1994-02			Expert, Partner, Ranch	1996 ->
Jumpy	1996 ->				
Xantia, Xantia Break	1998 ->				
XSara, XSara Coupe, Break	1997 ->				
XSara Picasso	2000->				

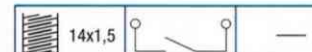

Reemplaza / Suitable:  
Fiat 9633875580  
PSA 2257.43  
Toyota SU001-00467



**40492**

Aislante gris / Grey colour

CITROËN		CITROËN Cont.		PEUGEOT	
Berlingo 1.1i, 1.4i	1996 ->	Saxo	1996-02	106	1996 ->
C2	2003 ->	Xantia, Xantia Break	1998 ->	206 1.1i, 1.4i, 1.6i	1998 ->
C3	2002 ->	XM	1994-00	306 1.4i, 1.6i	1994 ->
C4	2004 ->	XSara, XSara Coupe, Break	1997 ->	307, 307 Station Wagon	2000 ->
C5 HDI 2.0, 2.2, Break	2001 ->			406, 406 Coupe, Break	1997 ->
C8 HDI 2.0, 2.2	2002 ->			605	1989-99
Evasion 1.9 TD, 2.1 TD	1994-02			607	2000 ->
Jumper, Break, Bus	1994-02			Boxer	1994 ->
Jumpy 1.9 TD, 2.0 HDI	1995 ->			Expert, Partner, Ranch	1996 ->

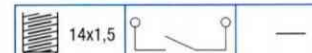

Reemplaza / Suitable:  
Nissan 32005-6F901  
PSA 2257.42

**IMPORTANTE:**

Al pedir accesorios eléctricos, rogamos completen la referencia comenzando por 'F' (ejemplo: 381394 → F381394)

Pour commander accessoires électriques, nous vous prions de compléter la référence en commençant par 'F'.

When ordering electric accessories, please complete the reference by beginning with 'F'.



## ACCESORIOS ELÉCTRICOS

## ACCESSOIRES ELECTRIQUES / ELECTRIC ACCESSORIES

**INTERRUPTORES DE LUZ MARCHA ATRAS**  
**REVERSING LIGHT SWITCHES**  
**CONTACTEURS DE PHARE DE RECUL**
**40570**

Aislante negro, Aro amarillo / Black colour, Yellow ring

**CITROËN**

AX	1989 ->
Berlingo 1.1 i, 1.4 i	1996 ->
BX, BX 14, PR-4711->	1989-91
C 15 E	1989-96
Evasion 2.0 i T, Turbo D	1995 ->
Jumper, Jumpy	1994 ->
Saxo	1994 ->
Xantia 2.0 i Turbo CT	1996 ->
Xantia 2.1 Turbo D	1995 ->
XSara 1.4 i, 1.6 i	1995 ->
XSara 1.5 D, 1.8 D	1997 ->
XM 2.0 i Turbo, 3.0 V6	1997 ->
XM 2.1 TD, 2.5 TD	1990 ->
ZX 1.1 i, 1.4 i Monopoint	1991 ->

**PEUGEOT**

106	1991 ->
205 Motores/Engines TU	1987-94
206 1.9 Diesel	1998 ->
306 1.1 i, 1.4 i, 1.6 i	1993 ->
306 1.7 Diesel (XAD)	1994-97
309 1.1, 1.3, 1.3 i, (TU)	1989-93
405 1.4 GL, GR, (TU3)	1990-93
405 1.4 i (TU3M)	1993-95
406 2.0 i Turbo, 2.0 i V6	1996 ->
406 2.1 Turbo D	1996 ->
605 3.0 i V6 (ZPJ)	1990 ->
605 3.0 i V6 24V (ZPJ4)	1990 ->
605 2.1 Turbo D	1990 ->
605 2.5 Turbo D	1994 ->

**PEUGEOT COMM.**

806 2.0 i Turbo, 16V	1994 ->
806 1.9 TD, 2.1 TD	1994 ->
Boxer	1994 ->
Expert 1.9 TD	1996 ->
Partner 1.1 i, 1.4 i, 1.8 i	1996 ->
Ranch	1996 ->

Caja de cambios MA, ME, MG, ML.  
MA, ME, MG, ML gear box.  
Boîte de vitesses MA, ME, MG, ML.

## Reemplaza / Suitable:

Citroën	96.018.110
Peugeot	2257.34
PSA	2257.40



14x1,5

**41070****CITROËN**

C 25 E 1.8, 2.0	1981-89
C 25 D 1905 cc.	1988-89
C 25 D 2500, Turbo D	1981-89
CX 2000, CX 2200	1974-85
CX 2.0, CX 2.2	1979-89
CX 2400 Pallas, GTI, Inj.	1976-89
CX 2.5 IE, GTI, GTI Turbo	1983-89
CX 2.5 Diesel, Turbo D	1978-89
Mehari	1974-88

**PEUGEOT COMM.**

J 5

**TALBOT GROUP**

Alpine 1.3, 1.5, 1.6	1975-84
Horizon 1.1, 1.3, 1.5	1978-86
Simca	1975-86
Solara GLS, SX, 1.3, 1.6	1980-84
150 GT, S, SX	1977-86

Modelos con 5 velocidades.  
Models with 5 speeds.  
Modèles avec 5 vitesses.

6,35 mm



12x1



## Reemplaza / Suitable:

Citroën	5.434.394
	75.454.205
	75.491.289
Fiat	75491289
Peugeot	2257.22
Talbot	7545 420 500

**41090****CITROËN**

AX 10, AX 11, AX 14, GT	1987-89
Axel	1984-90
BX	1983-89
C 15 E, C 15 D	1984-89
C 25 E, C 25 D	1989-93
LNA 11 E, RE, RS	1982-86
Visa, Visa II	1978-89

**PEUGEOT**

104	1972-85
205	1983-88
305	1983-88
309	1986-90
405	1987-90

**TALBOT-SIMCA**

Horizon, Samba	1981-86
----------------	---------



5 mm



14x1,5



## Reemplaza / Suitable:

Citroën	91.513.244
	91.514.017,733
Peugeot	2257.17
Renault	77 00 591 730
	77 00 732 506
	77 01 348 716
	77 02 112 857
Volvo	3416102-6

**40650**

Aislante blanco, Aro azul / White colour, Blue ring

**CITROËN**

Berlingo 1.8 D, 1.9 D, 1.8 i	1996-99
BX 16, BX 19, GTI, 16V	1989-93
BX D, BX Turbo D	1989-93
C 15 D	1989-96
Evasion 1.8 i, 2.0 i	1994-98
Jumpy 1580 SPI	1995-98
Jumpy 1.9 D (XUD9A)	1995-98
Xantia 1.6 i, 1.8 i, 2.0 i	1993-97
Xantia 1.8 i 16V	1995-99
Xantia 2.0 i 16V	1993-98
Xantia 1.9 D, SD, TD	1993-98
XM 2.0 Carb. (XU102C)	1989-94
XM 2.0 i (XU10J2, K, Z)	1989-96
XM 2.0 i 16V (XU10J4R)	1994-96
XM 2.1 Diesel (XUD11A)	1989-96
XSara Diesel, Turbo D	1997-99
XSara 1.8 i 16V, 2.0 i 16V	1997-99
ZX 1.6 i, 1.8 i	1991-96
ZX 1.9 i Volcane	1991-92
ZX 2.0 i, 2.0 i 16V	1992-96
ZX 1.9 D, 1.9 Turbo D	1991-96

**PEUGEOT**

205 1.3, 1.6, GTX	1985-94
205 1.6 GTI, 1.9 GTI	1987-94
205 1.7 D, 1.9 D. (XUD)	1987-94
205 1.7 Turbo D (XUD7T)	1991-94
206 1.1 i, 1.4 i, 1.6 i	1998-00
206 1.9 Diesel	1998-00
306 1.7 Diesel	1997-99
306 1.8 i, 2.0 i, 16V	1993-97
306 1.9 D, 1.9 Turbo D	1993-98
309 1.1, 1.3. (E1, G1, G2)	1990-92
309 1.5 GR, SX, (Y2)	1990-92
309 1.6 SR (J2)	1990-92
309 1.6, 1.9. (XU)	1990-93
309 1.6 i, 1.9 GTI, 16V	1990-93
309 1.7 D, 1.9 D	1990-93
309 1.7 Turbo D (XUD7T)	1990-93
405 1.6, 1.9. (XU Carb.)	1990-92

**PEUGEOT Cont.**

405 1.6 i, 1.9 i, MI 16	1990-95
405 1.7 D, 1.9 D	1991-93
405 1.7 Turbo D	1990-93
405 1.9 D, 1.9 Turbo D	1993-95
406 1.6 i, 1.8 i, 2.0 i 16V	1996-98
406 1.9 TD (XUD9TE)	1996-98
406 Coupe	1997-99
605 2.0 i, 2.0 i 16V	1990-98
605 2.1 D (XUD11A)	1991-94
607	2000 ->
806 1.8 i	1996-99
806 2.0 i SR, ST	1994-98

**PEUGEOT COMM.**

Expert 1580 SPI, 1.8 i	1996-00
Expert 1.9 D	1996-99
Partner 1.7 D, 1.9 D	1996-99
Ranch 1.1 i, 1.4 i, 1.8 i	1996-99
Ranch 1.7 D, 1.9 D	1996-99
Caja de cambios BE3.	
BE3 gear box.	
Boîte de vitesses BE3.	



## Reemplaza / Suitable:

Citroën	96.018.108
Peugeot	2257.33
PSA	2257.41



14x1,5

**IMPORTANTE:**

Al pedir accesorios eléctricos, rogamos completen la referencia comenzando por 'F' (ejemplo: 381394 → F381394)

Pour commander accessoires électriques, nous vous prions de compléter la référence en commençant par 'F'.

When ordering electric accessories, please complete the reference by beginning with 'F'.

**CONMUTADORES, INTERRUPTORES, PULSADORES  
PANNEL SWITCHES, PRESS BUTTONS  
CONMUTATEURS, INTERRUPTEURS, POUSSOIRS**

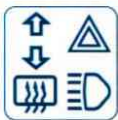
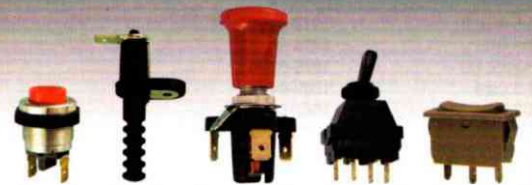

**INTERRUPTORES TABLERO  
TUMBLER SWITCHES FOR PANNEL  
INTERRUPTEURS TABLEAU**



**PULSADORES  
PRESS BUTTONS  
POUSSOIRS**



**INTERRUPTORES SEAT-FIAT  
SEAT-FIAT SWITCHES  
INTERRUPTEURS SEAT-FIAT**



**INTERRUPTORES VARIOS  
DIVERS SWITCHES  
INTERRUPTEURS DIVERS**



**INTERRUPTORES PUERTA Y ALARMA  
DOOR AND ALARM SWITCHES  
CONTACTEUR DE PORTE ET AVERTISSEUR**



# ACCESORIOS ELÉCTRICOS

## ACCESSOIRES ELECTRIQUES / ELECTRIC ACCESSORIES



MATERIAL ELECTRICO / MATERIEL ELECTRIQUE / ELECTRIC PARTS



### INTERRUPTORES TABLERO TUMBLER SWITCHES FOR PANNEL INTERRUPTEURS TABLEAU

#### 61510

negro / black / noir

CITROEN	1982-86	PEUGEOT	1980-85
LNA	104	1980-85	1980-85
	205	1984-87	1984-87
	305	1977-88	1977-88
	504	1979-82	1979-82
	505	1979-85	1979-85
	J 7, J 9	1984-88	1984-88

Conmutador iluminado warning.  
Illuminated warning switch.  
Commutateur éclairé, signal détresse

Con lámpara/With lamp/Avec lampe  
12 V.

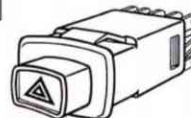

Reemplaza / Suitable:  
Peugeot 6550.23

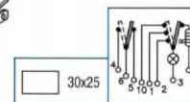

#### 61530

negro / black / noir

CITROEN	1982-86	PEUGEOT	1980-85
LNA	104	1980-85	1980-85
	205	1984-87	1984-87
	305	1977-88	1977-88
	504	1979-82	1979-82
	505	1979-85	1979-85
	J 7, J 9	1984-88	1984-88

Interruptor iluminado faros antiniebla.  
Illuminated fog lamps switch.  
Interrupteur éclairé feux de brouillard.

Iluminación ámbar  
Illumination amber. Lumière jaune.

Con lámpara/With lamp/Avec lampe  
12 V.

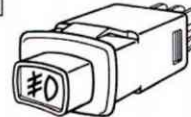

Reemplaza / Suitable:  
Peugeot 6550.25  
6552.27

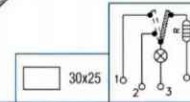

#### 61550

negro / black / noir

CITROEN	1982-86	PEUGEOT	1980-85
LNA	104	1980-85	1980-85
	205	1984-87	1984-87
	305	1977-88	1977-88
	504	1979-82	1979-82
	505	1979-85	1979-85
	J 7, J 9	1984-88	1984-88

Interruptor universal o aire acondicionado.  
Universal switch or air conditioned.  
Interrupteur universel ou air conditionné.

Con lámpara/With lamp/Avec lampe  
12 V.

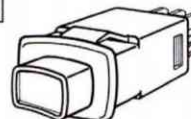

Reemplaza / Suitable:  
Peugeot 6552.24

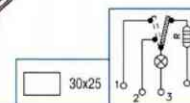

#### 62040

TALBOT	1977-84
Matra Rancho	1977-84
Simca 1000	1974-78
Simca 1100	1972-81
Simca 1200 (E)	1970-82
180. 2 l.	1975-80
2000 Diesel	1975-80

Interruptor emergencia iluminado.  
Interrupteur éclairé signal détresse.

Tecla translúcida, aspecto rojo.  
Marco brillante.  
Bouton translucide aspect rouge.  
Cache brillant.  
Para lámpara/Pour lampe BA 9s.



Reemplaza / Suitable:  
Talbot 0053966800  
4453966800

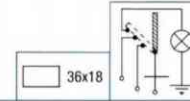

#### 62060

PEUGEOT	1960-80
104, 204, 304, 404	1960-80
504	1968-78
604	1975-87
J 7, J 9	1969-84

Conmutador emergencia.  
Commutateur signal détresse.

Tecla negra. Marco brillante.  
Bouton noir. Cache brillant.



Reemplaza / Suitable:

Peugeot 6338.05, 06  
Renault 77 00 557 581  
77 00 646 226  
77 00 348 301

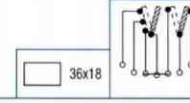

#### 62070

PEUGEOT	1968-78
504	1968-78

Interruptor calefacción.  
Interrupteur chauffage.

Tecla negra. Marco brillante.  
Bouton noir. Cache brillant.



Reemplaza / Suitable:  
Peugeot 6475.15

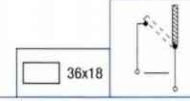

#### 62110

TALBOT	1961-77
Simca 900 (E)	1961-77
Simca 1000	1974-78
Simca 1000 Rancho	

Interruptor limpia-parabrisas,  
1 velocidad.  
Interrupteur essuie vitre, 1 vitesse.

Tecla negra. Marco brillante.  
Bouton noir. Cache brillant.



Reemplaza / Suitable:  
Renault 08 55 927 100  
Talbot SE-71461070

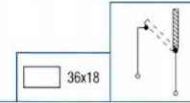

### IMPORTANTE:

Al pedir accesorios eléctricos, rogamos completen la referencia comenzando por 'F' (ejemplo: 381394 → F381394)  
Pour commander accessoires électriques, nous vous prions de compléter la référence en commençant par 'F'.  
When ordering electric accessories, please complete the reference by beginning with 'F'.

# ACCESORIOS ELÉCTRICOS

## ACCESSOIRES ELECTRIQUES / ELECTRIC ACCESSORIES



MATERIAL ELECTRICO / MATERIEL ELECTRIQUE / ELECTRIC PARTS

**INTERRUPTORES TABLERO**  
**TUMBLER SWITCHES FOR PANNEL**  
**INTERRUPTEURS TABLEAU**

<p><b>62130</b></p> <p><b>PEUGEOT</b></p> <table style="width: 100%; border: none;"> <tr> <td style="border: none;">104, 204, 304</td> <td style="border: none;">1966-80</td> </tr> <tr> <td style="border: none;">404</td> <td style="border: none;">1960-72</td> </tr> <tr> <td style="border: none;">504</td> <td style="border: none;">1968-78</td> </tr> </table>	104, 204, 304	1966-80	404	1960-72	504	1968-78	<p>Commutador limpia-parabrisas, 2 velocidades. Commutateur essuie vitre, 2 vitesses.</p> <p>Tecla negra. Marco brillante. Bouton noir. Cache brillant.</p>	<p>6,35 mm</p>	<p><b>Reemplaza / Suitable:</b> <b>Peugeot</b> 6409.26 6409.40</p>
104, 204, 304	1966-80								
404	1960-72								
504	1968-78								

<p><b>62150</b></p> <p><b>PEUGEOT</b></p>	<p>Interruptor sin simbolo. Interrupteur sans symbole.</p> <p>Tecla negra. Marco brillante. Bouton noir. Cache brillant.</p>	<p>6,35 mm</p>	<p><b>Reemplaza / Suitable:</b> <b>Peugeot</b> 6409.29 6409.31 6409.36</p>
---	--	----------------	--

<p><b>62190</b></p> <p><b>CITROËN</b> <b>PEUGEOT</b></p> <p>CX</p>	<p>Interruptor con lentilla ámbar. Interrupteur avec lentille jaune.</p> <p>Tecla negra. Marco brillante. Bouton noir. Cache brillant.</p> <p>Para lámpara BA 9s. Pour lampe BA 9s.</p>	<p>6,35 mm</p>	<p><b>Reemplaza / Suitable:</b> <b>Citroën</b> 95.493.978 <b>Peugeot</b> 7920.046.119</p>
--	---	----------------	---

<p><b>62210</b></p> <p><b>PEUGEOT</b></p> <table style="width: 100%; border: none;"> <tr> <td style="border: none;">104, 204, 304, 404</td> <td style="border: none;">1960-80</td> </tr> <tr> <td style="border: none;">504</td> <td style="border: none;">1968-78</td> </tr> </table>	104, 204, 304, 404	1960-80	504	1968-78	<p><b>TALBOT</b></p> <table style="width: 100%; border: none;"> <tr> <td style="border: none;">Matra Rancho</td> <td style="border: none;">1977-84</td> </tr> <tr> <td style="border: none;">Simca 1000 Rancho</td> <td style="border: none;">1976-78</td> </tr> <tr> <td style="border: none;">Simca 1300.1301.1500.</td> <td style="border: none;">1963-75</td> </tr> <tr> <td style="border: none;">1501, 180, 21</td> <td style="border: none;">1975-80</td> </tr> </table>	Matra Rancho	1977-84	Simca 1000 Rancho	1976-78	Simca 1300.1301.1500.	1963-75	1501, 180, 21	1975-80	<p>6,35 mm</p>	<p><b>Reemplaza / Suitable:</b> <b>Peugeot</b> 6409.32 <b>Renault</b> 77.00.552.517</p>
104, 204, 304, 404	1960-80														
504	1968-78														
Matra Rancho	1977-84														
Simca 1000 Rancho	1976-78														
Simca 1300.1301.1500.	1963-75														
1501, 180, 21	1975-80														

<p><b>62290</b></p> <p><b>TALBOT</b></p> <table style="width: 100%; border: none;"> <tr> <td style="border: none;">Simca 900 (E)</td> <td style="border: none;">1961-77</td> </tr> <tr> <td style="border: none;">Simca 1000</td> <td style="border: none;">1963-76</td> </tr> <tr> <td style="border: none;">Simca 1100 (F)</td> <td style="border: none;">1972-81</td> </tr> <tr> <td style="border: none;">Simca 1200 GLE (E)</td> <td style="border: none;">1971-74</td> </tr> </table>	Simca 900 (E)	1961-77	Simca 1000	1963-76	Simca 1100 (F)	1972-81	Simca 1200 GLE (E)	1971-74	<p>Interruptor luces de tablero. Interrupteur éclairage tableau de bord.</p> <p>Tecla negra. Marco brillante. Bouton noir. Cache brillant.</p>	<p>6,35 mm</p>	<p><b>Reemplaza / Suitable:</b> <b>Talbot</b> SA-71441000 SL-71441070</p>
Simca 900 (E)	1961-77										
Simca 1000	1963-76										
Simca 1100 (F)	1972-81										
Simca 1200 GLE (E)	1971-74										

<p><b>62300</b></p> <p><b>TALBOT</b></p> <table style="width: 100%; border: none;"> <tr> <td style="border: none;">Simca 900 (E)</td> <td style="border: none;">1961-77</td> </tr> <tr> <td style="border: none;">Simca 1000</td> <td style="border: none;">1963-74</td> </tr> <tr> <td style="border: none;">Simca 1100 (F)</td> <td style="border: none;">1972-81</td> </tr> <tr> <td style="border: none;">Simca 1200 (E)</td> <td style="border: none;">1970-82</td> </tr> <tr> <td style="border: none;">Simca 1200 GLE (E)</td> <td style="border: none;">1971-74</td> </tr> <tr> <td style="border: none;">Simca 1200 L, GLS. (E)</td> <td style="border: none;">1974-77</td> </tr> <tr> <td style="border: none;">180, 21.</td> <td style="border: none;">1975-80</td> </tr> <tr> <td style="border: none;">2000 Diesel</td> <td style="border: none;">1975-80</td> </tr> </table>	Simca 900 (E)	1961-77	Simca 1000	1963-74	Simca 1100 (F)	1972-81	Simca 1200 (E)	1970-82	Simca 1200 GLE (E)	1971-74	Simca 1200 L, GLS. (E)	1974-77	180, 21.	1975-80	2000 Diesel	1975-80	<p>Interruptor limpia-parabrisas, 1 velocidad. Interrupteur essuie vitre, 1 vitesse.</p> <p>Tecla negra. Marco brillante. Bouton noir. Cache brillant.</p>	<p>6,35 mm</p>	<p><b>Reemplaza / Suitable:</b> <b>Talbot</b> 0053116800 30346 E SG-71461000</p>
Simca 900 (E)	1961-77																		
Simca 1000	1963-74																		
Simca 1100 (F)	1972-81																		
Simca 1200 (E)	1970-82																		
Simca 1200 GLE (E)	1971-74																		
Simca 1200 L, GLS. (E)	1974-77																		
180, 21.	1975-80																		
2000 Diesel	1975-80																		

<p><b>62330</b></p> <p><b>PEUGEOT</b></p> <p>504</p>	<p>Commutador calefacción, 2 velocidades. Commutateur chauffage, 2 vitesses.</p> <p>Tecla negra. Marco brillante. Bouton noir. Cache brillant.</p>	<p>6,35 mm</p>	<p><b>Reemplaza / Suitable:</b> <b>Renault</b> 77.00.520.122 77.00.520.241</p>
--	--	----------------	--

### IMPORTANTE:

**Al pedir accesorios eléctricos, rogamos completen la referencia comenzando por 'F' (ejemplo: 381394 → F381394)**  
*Pour commander accessoires électriques, nous vous prions de compléter la référence en commençant par 'F'.*  
 When ordering electric accessories, please complete the reference by beginning with 'F'.



## ACCESORIOS ELÉCTRICOS

## ACCESSOIRES ELECTRIQUES / ELECTRIC ACCESSORIES



**INTERRUPTORES TABLERO**  
**TUMBLER SWITCHES FOR PANNEL**  
**INTERRUPTEURS TABLEAU**

**62480**

PEUGEOT

Motores/Engines/Moteurs:  
Diesel.

Pulsador pre-calentamiento diesel.  
Poussoir démarrage et préchauffage diesel.

Tecla negra. Marco brillante.  
Bouton noir. Cache brillant.

6,35 mm



Reemplaza / Suitable:  
Peugeot 5868.56

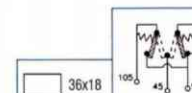

**62500**

PEUGEOT

404	1972-75
504	1968-78

Conmutador limpia-parabrisas, 2 velocidades.  
Commutateur essuie vitre, 2 vitesses.

Tecla negra. Marco brillante.  
Bouton noir. Cache brillant.



Reemplaza / Suitable:

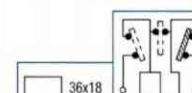

**62510**

PEUGEOT

J7. J9	1969-84
--------	---------

TALBOT

Horizon	1977-86
Samba	1981-86
Simca 1000. 1000 Rancho	1974-78
Simca	1963-75
1300.1301.1500.1501	1975-80
180. 2 l.	

Conmutador calefacción, 2 velocidades.  
Commutateur chauffage, 2 vitesses.

Tecla negra. Marco brillante.  
Bouton noir. Cache brillant.



Reemplaza / Suitable:

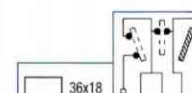

**62540**

CITROËN

CX	1976-85
C 25 D. C 25 D	1981-85

PEUGEOT

504	1968-82
-----	---------

Inversor eleva-lunas.  
Inverseur lève-vitres.

Tecla negra. Marco brillante.  
Bouton noir. Cache brillant.



Reemplaza / Suitable:  
Citroën 5.476.771  
Peugeot 5.490.843  
6609.03

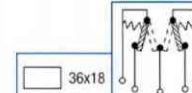

**62550**

CITROËN

CX	1976-85
----	---------

PEUGEOT

504	1968-78
604	1975-87

Inversor eleva-lunas.  
Inverseur lève-vitres.

Tecla negra. Marco negro.  
Bouton noir. Cache noir.



Reemplaza / Suitable:  
Peugeot 6550.05

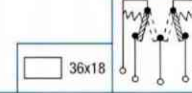

**62580**

CITROËN

BX	1987-93
----	---------

TALBOT

Tagora	1981-84
--------	---------

PEUGEOT

205	1984-92
309	1986-93
405	1987-93
505	1979-85

Inversor eleva-lunas. Techo corredizo.  
Inverseur lève-vitres. Toit ouvrant.

Tecla negra.  
Bouton noir.

No iluminado.  
Non éclairage.

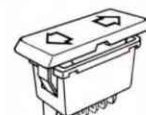

Reemplaza / Suitable:  
Citroën 97.513.687  
Peugeot 6551.21  
Talbot 00567459XX

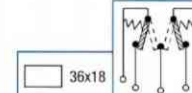

**62590**

CITROËN

BX	1983-86
GS. GSA	1980-86
Visa	1981-89

TALBOT

Horizon	1977-81
Samba. Solara. 150	1981-86
Simca 1307. 1308. 1309	1975-79
Simca 1510	1979-86

PEUGEOT

604	1975-87
-----	---------

Inversor eleva-lunas.  
Inverseur lève-vitres.

Tecla negra. Marco negro.  
Bouton noir. Cache noir.

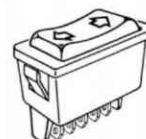

Reemplaza / Suitable:  
Citroën 95.495.141  
95.571.231  
Renault 77 00 676 698  
Talbot 0057093400  
511460347

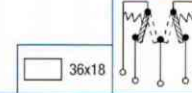

### IMPORTANTE:

Al pedir accesorios eléctricos, rogamos completen la referencia comenzando por 'F' (ejemplo: 381394 → F381394)

Pour commander accessoires électriques, nous vous prions de compléter la référence en commençant par 'F'.

When ordering electric accessories, please complete the reference by beginning with 'F'.

# ACCESORIOS ELÉCTRICOS

## ACCESSOIRES ELECTRIQUES / ELECTRIC ACCESSORIES

<b>INTERRUPTORES TABLERO</b> <b>TUMBLER SWITCHES FOR PANNEL</b> <b>INTERRUPTEURS TABLEAU</b>																																								
<b>62600</b>																																								
<table border="1"> <tr><th colspan="2">CITROËN</th></tr> <tr><td>BX</td><td>1987-93</td></tr> <tr><td>GSA</td><td>1980-86</td></tr> <tr><td>Visa</td><td>1981-89</td></tr> <tr><th colspan="2">PEUGEOT</th></tr> <tr><td>604</td><td>1975-87</td></tr> </table>	CITROËN		BX	1987-93	GSA	1980-86	Visa	1981-89	PEUGEOT		604	1975-87	<table border="1"> <tr><th colspan="2">TALBOT</th></tr> <tr><td>Horizon</td><td>1981-86</td></tr> <tr><td>Simca 1307, 1308, 1309</td><td>1975-79</td></tr> <tr><td>Simca 1510</td><td>1979-86</td></tr> <tr><td>Solara</td><td>1977-86</td></tr> </table>	TALBOT		Horizon	1981-86	Simca 1307, 1308, 1309	1975-79	Simca 1510	1979-86	Solara	1977-86	Inversor eleva-lunas. Inverseur lève-vitres.  Tecla negra. Marco negro. Bouton noir. Cache noir.	Reemplaza / Suitable: Renault 77 00 676 697															
CITROËN																																								
BX	1987-93																																							
GSA	1980-86																																							
Visa	1981-89																																							
PEUGEOT																																								
604	1975-87																																							
TALBOT																																								
Horizon	1981-86																																							
Simca 1307, 1308, 1309	1975-79																																							
Simca 1510	1979-86																																							
Solara	1977-86																																							
<b>62640</b>																																								
<table border="1"> <tr><th colspan="2">CITROËN</th></tr> <tr><td>BX (PR-3487 -&gt;)</td><td>1986-93</td></tr> <tr><th colspan="2">PEUGEOT</th></tr> <tr><td>205</td><td>1986-93</td></tr> <tr><td>305, 309</td><td>1986-93</td></tr> <tr><td>405</td><td>1987-93</td></tr> <tr><td>505</td><td>1986-91</td></tr> </table>	CITROËN		BX (PR-3487 ->)	1986-93	PEUGEOT		205	1986-93	305, 309	1986-93	405	1987-93	505	1986-91	<table border="1"> <tr><th colspan="2">TALBOT</th></tr> <tr><td>Tagora</td><td>1981-84</td></tr> </table>	TALBOT		Tagora	1981-84	Inversor iluminado eleva-lunas. Inverseur éclairé lève-vitres.  Tecla negra. Bouton noir.  Con lámpara/With lamp/Avec lamp 12 V.	Reemplaza / Suitable: Citroën 96.048.371 Peugeot 6552.67																			
CITROËN																																								
BX (PR-3487 ->)	1986-93																																							
PEUGEOT																																								
205	1986-93																																							
305, 309	1986-93																																							
405	1987-93																																							
505	1986-91																																							
TALBOT																																								
Tagora	1981-84																																							
<b>62650</b>																																								
<table border="1"> <tr><th colspan="2">CITROËN</th></tr> <tr><td>AX 10, AX 11, AX 14</td><td>1987-91</td></tr> <tr><td>AX GT, AX Sport</td><td>1987-91</td></tr> <tr><td>AX 14 Diesel</td><td>1988-91</td></tr> <tr><td>BX (Techo correerizo)</td><td>1986-93</td></tr> </table>	CITROËN		AX 10, AX 11, AX 14	1987-91	AX GT, AX Sport	1987-91	AX 14 Diesel	1988-91	BX (Techo correerizo)	1986-93		Inversor iluminado eleva-lunas. Inverseur éclairé lève-vitres.  Tecla negra. Bouton noir.  Con lámpara/With lamp/Avec lamp 12 V.	Reemplaza / Suitable: Citroën 95.611.003																											
CITROËN																																								
AX 10, AX 11, AX 14	1987-91																																							
AX GT, AX Sport	1987-91																																							
AX 14 Diesel	1988-91																																							
BX (Techo correerizo)	1986-93																																							
<b>62660</b>																																								
<table border="1"> <tr><th colspan="2">CITROËN</th></tr> <tr><td>AX (PR-5285-&gt;)</td><td>1992 -&gt;</td></tr> <tr><td>ZX (-&gt;PR-6016)</td><td>1991 -&gt;</td></tr> </table>	CITROËN		AX (PR-5285->)	1992 ->	ZX (->PR-6016)	1991 ->		Inversor eleva-lunas. Inverseur lève-vitres.  Tecla negra. Bouton noir.	Reemplaza / Suitable: Citroën 96.082.965 ZL																															
CITROËN																																								
AX (PR-5285->)	1992 ->																																							
ZX (->PR-6016)	1991 ->																																							
<b>62910</b>																																								
<table border="1"> <tr><th colspan="2">TALBOT</th></tr> <tr><td>Simca 900, 1000</td><td>1961-77</td></tr> </table>	TALBOT		Simca 900, 1000	1961-77		Conmutador calefacción, 2 velocidades. Commutateur chauffage, 2 vitesses.  Tecla gris. Marco negro. Bouton gris. Cache noir.	Reemplaza / Suitable: Fiat 4132032 Seat HB-952700.01 HB-952700.02																																	
TALBOT																																								
Simca 900, 1000	1961-77																																							
<b>67180</b>																																								
<table border="1"> <tr><th colspan="2">PEUGEOT COMM.</th></tr> <tr><td>J 5</td><td>1981 -&gt;</td></tr> </table>	PEUGEOT COMM.		J 5	1981 ->		Interruptor puerta y freno de mano. Door and hand brake switch. Contacteur porte et frein à main.	Reemplaza / Suitable: Peugeot 6366.32																																	
PEUGEOT COMM.																																								
J 5	1981 ->																																							
<b>67210</b>																																								
<table border="1"> <tr><th colspan="2">CITROËN</th></tr> <tr><td>AX</td><td>1987-96</td></tr> <tr><td>BX</td><td>1983-93</td></tr> <tr><td>C 15</td><td>1984-93</td></tr> <tr><td>CX, GS, GSA</td><td>1974-89</td></tr> <tr><td>Evasion</td><td>1995-98</td></tr> <tr><td>LN, LNA, Visa</td><td>1976-89</td></tr> <tr><td>Saxo</td><td>1996-98</td></tr> <tr><td>XM</td><td>1989-93</td></tr> <tr><td>ZX</td><td>1991-96</td></tr> </table>	CITROËN		AX	1987-96	BX	1983-93	C 15	1984-93	CX, GS, GSA	1974-89	Evasion	1995-98	LN, LNA, Visa	1976-89	Saxo	1996-98	XM	1989-93	ZX	1991-96	<table border="1"> <tr><th colspan="2">PEUGEOT</th></tr> <tr><td>104, 305, 504, 505, 604</td><td>1968-89</td></tr> <tr><td>106</td><td>1991-96</td></tr> <tr><td>205, 309, 405</td><td>1983-93</td></tr> <tr><td>605</td><td>1990-96</td></tr> <tr><td>806</td><td>1994-98</td></tr> </table>	PEUGEOT		104, 305, 504, 505, 604	1968-89	106	1991-96	205, 309, 405	1983-93	605	1990-96	806	1994-98	<table border="1"> <tr><th colspan="2">TALBOT</th></tr> <tr><td>Samba</td><td>1981-86</td></tr> </table>	TALBOT		Samba	1981-86	Interruptor puerta y freno de mano. Door and hand brake switch. Contacteur porte et frein à main.	Reemplaza / Suitable: Citroën 5.490.703 92.503.165 95.493.782 95.544.513 Peugeot 6366.08, 09 6366.13, 24 Talbot 7920017929
CITROËN																																								
AX	1987-96																																							
BX	1983-93																																							
C 15	1984-93																																							
CX, GS, GSA	1974-89																																							
Evasion	1995-98																																							
LN, LNA, Visa	1976-89																																							
Saxo	1996-98																																							
XM	1989-93																																							
ZX	1991-96																																							
PEUGEOT																																								
104, 305, 504, 505, 604	1968-89																																							
106	1991-96																																							
205, 309, 405	1983-93																																							
605	1990-96																																							
806	1994-98																																							
TALBOT																																								
Samba	1981-86																																							

### IMPORTANTE:

Al pedir accesorios eléctricos, rogamos completen la referencia comenzando por 'F' (ejemplo: 381394 → F381394)

Pour commander accessoires électriques, nous vous prions de compléter la référence en commençant par 'F'.

When ordering electric accessories, please complete the reference by beginning with 'F'.



ACCESORIOS ELÉCTRICOS

ACCESSOIRES ELECTRIQUES / ELECTRIC ACCESSORIES



**CALENTADORES - STANDARD**  
**STANDARD - GLOW PLUGS**  
**BOUGIES DE PRECHAUFFAGE - STANDARD**



**SOLENOIDES - ELECTROVALVULAS**  
**DIESEL STOP SOLENOID SWITCHES**  
**SOLENOIDES - ELECTROVANNES**



**CALENTADORES - TERMOPLUS**  
**TERMOPLUS - GLOW PLUGS**  
**BOUGIES DE PRECHAUFFAGE - TERMOPLUS**



**SONDAS LAMBDA**  
**OXYGEN SENSORS**  
**SONDES LAMBDA**



**CAPTADORES DE IMPULSOS**  
**REVOLUTION AND TIMING SENSORS**  
**CAPTEURS DU REGIME ET DES POSITIONS**

**SOLENOIDES, CALENTADORES, S. LAMBDA, CAPTADORES**  
**GLOW PLUGS, OXYGEN AND TIMING SENSORS**  
**BOUGIES DE PRECHAUFFAGE, SONDES ET CAPTEURS**



**ACCESORIOS ELÉCTRICOS**
**ACCESSOIRES ELECTRIQUES / ELECTRIC ACCESSORIES**

**CALENADORES - TERMOPLUS**  
**TERMOPLUS - GLOW PLUGS**  
**BOUGIES DE PRÉCHAUFFAGE - TERMOPLUS**
**74140**

CITROËN	PEUGEOT	PEUGEOT IND.
Berlingo 1.8 D, 1.9 D	1996-98 205 1.8 D, TD, 1.9 D	1983-94 806 1.9 TD, 2.1 TD
C 15 D	1986-97 304 1.5 D (XIDL)	1994-98 1994-98 Boxer D, Turbo D
C 25 D, TD	1981-94 305 1.6 D, 1.9 D	1979-90 Expert 1.9 D, TD
C 32 D (CRD90)	1981-94 306 1.6 D, 1.9 D	1977-81 J 5 1.9 D (XUD9A)
C 35 D (CRD90, 93B)	1979-80 309 1.7 D, TD, 1.9 D	1993-98 J 5 2.5 D, TD, (CRD93)
C 45 D	1979-91 405 D, Turbo D	1986-93 J 7 2.3 D (X2DP)
CX 25 D, 25 Turbo D	1982-92 406 2.1 TD, Break	1988-98 J 9 2.1 D (XDP4)
Evasion 1.9 TD, 2.1 TD	1982-92 504 Diesel	1978-81 Partner 1.8 D, 1.9 D
Jumper D, TD	1994-98 505 D, Turbo D	1981-91 Ranch 1.9 D (XUD9A)
Jumpy D, TD	1994-98 604 2.3 TD (XD2S)	1983-86 1983-86
Xantia D, TD	1993-98 605 D, Turbo D	1989-98 1989-98
XM D, TD		
Visa 17 Diesel		
ZX D, TD		

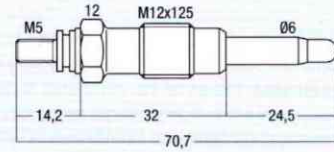
**Reemplaza/Suitable:** PSA 5961.40, 5961.53, 5961.58  
 PSA 5962.1R, 5962.1V, 5962.3H, 5962.3J  
 PSA 5962.4J, 5962.4S, 5962.46, 5962.45  
 PSA 5962.88, 5962.88, 5962.88, 5962.X1

11 V. &lt; 6 seg. ≤ 4 Nm. 15-25 Nm.

**74142**

CITROËN	PEUGEOT
AX 1.4 D, GTD, RD, TRD	1988-94 106 1.4 D, XND, XRD, XTD
BX 17 D (XUD7)	1985-93
BX 17 TD, TRD	1988-93
BX 19 D (XUD9)	1983-87
BX 19 D, Turbo D	1987-93
ZX 1.4 D	1994-96

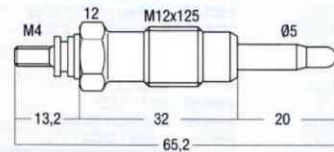
**Reemplaza/Suitable:** Beru GN927, GN918 Bosch 0250 202 001

11 V. &lt; 6 seg. ≤ 2,5 Nm. 15-25 Nm.

**74151**

CITROËN	PEUGEOT
AX 1.5 Diesel (TUD5)	1994-97 106 1.5 D
Berlingo 1.8 D (DW8)	1998 -> 206 1.9 D (DW8, DW8B)
Berlingo 1.8 Turbo D	1998 -> 306 1.8 D (DW8)
Jumpy 1.8 D (DW8)	1998 -> 306 1.8 Turbo D
Jumpy 1.8 Turbo D	1998 -> Expert 1.8 D (DW8)
Saxo 1.5 D	1996 -> Expert 1.8 TD (DW8TD)
Xsara 1.5 D, Break	1997 -> Partner 1.8 D (DW8, DW8B)
Xsara 1.9 D, Break, Coupe	1998 -> Partner 1.8 TD (DW8TD)
ZX 1.5 D	1996-97 1998 -> Ranch 1.9 D (DW8)

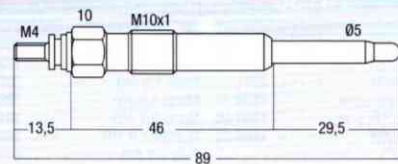
**Reemplaza/Suitable:** Beru GN912 Bosch 0250 202 020

11 V. &lt; 6 seg. ≤ 2,5 Nm. 10-15 Nm.

**74167**

CITROËN	PEUGEOT
Berlingo 2.0 HDI	2000 -> 206 2.0 HDI
Evasion 2.0 HDI	1999 -> 306 2.0 TD
Evasion 2.0 TD	1998 -> 307 2.0 HDI
Jumper 2.0 D	2001 -> 406 2.0 HDI 109 cv.
Jumpy 2.0 HDI	1998 -> 406 2.0 Break HDI 90 cv.
Xantia 2.0 D	1998 -> 806 2.0 HDI
Xsara 2.0 HDI 109 cv.	1998 -> Boxer 2.0 D
Xsara Picasso 2.0 HDI	1999 -> Expert 2.0 HDI (RHX, RHZ)
	1999 -> Partner 2.0 HDI

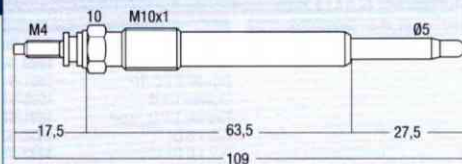
 Motores / Engines / Moteurs:  
 DW10, DW10TD, DW10TED.

**Reemplaza/Suitable:** Beru GN027 Bosch 0250 202 032

11 V. &lt; 6 seg. ≤ 2,5 Nm. 10-15 Nm.

**74180**

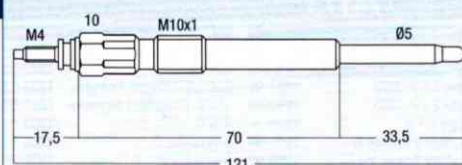
CITROËN	PEUGEOT
Jumper 2.5 TDI	1996 -> Boxer 2.5 TDI

 Motores / Engines / Moteurs:  
 DJ5TE.

**Reemplaza/Suitable:** Beru GN964 PSA 5962.1P, 5962.1Q

11 V. &lt; 6 seg. ≤ 2,5 Nm. 10-15 Nm.

**IMPORTANTE:**
**Al pedir accesorios eléctricos, rogamos completen la referencia comenzando por 'F' (ejemplo: 381394 → F381394)**
*Pour commander accessoires électriques, nous vous prions de compléter la référence en commençant par 'F'.*

When ordering electric accessories, please complete the reference by beginning with 'F'.



ACCESORIOS ELÉCTRICOS

ACCESSOIRES ELECTRIQUES / ELECTRIC ACCESSORIES



MATERIAL ELECTRICO / MATERIEL ELECTRIQUE / ELECTRIC PARTS



CALENTADORES - TERMOPLUS  
 TERMOPLUS - GLOW PLUGS  
 BOUGIES DE PRÉCHAUFFAGE - TERMOPLUS

74210

CITROEN		PEUGEOT	
C4 2.0 HDi	2004 ->	307 2.0 HDi	2003 ->
C4 Picasso 2.0 HDi	2006 ->	307 Break 2.0 HDi	2004 ->
C5 2.0 HDi	2004 ->	307 CC 2.0 HDi	2005 ->
C5 Break 2.0 HDi	2004 ->	307 SW 2.0 HDi	2004 ->
C8 2.2 HDi	2003 ->	407 2.0 HDi	2004 ->
		407 SW 2.0 HDi	2004 ->
		607 2.0 HDi	2005 ->

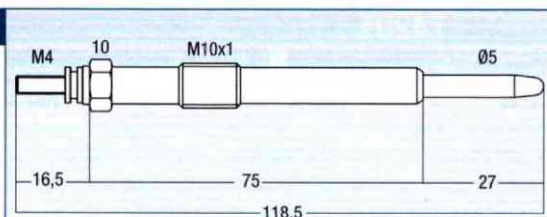

Reemplaza/Suitable: PSA 5960.64		Beru GN 054	
11 V.	< 6 seg.	≤ 2.5 Nm.	10±15 Nm.

**IMPORTANTE:**

Al pedir accesorios eléctricos, rogamos completen la referencia comenzando por 'F' (ejemplo: 381394 → F381394)  
 Pour commander accessoires électriques, nous vous prions de compléter la référence en commençant par 'F'.  
 When ordering electric accessories, please complete the reference by beginning with 'F'.

**ACCESORIOS ELÉCTRICOS**
**ACCESSOIRES ELECTRIQUES / ELECTRIC ACCESSORIES**

**DIMENSIONES Y VALORES**  
**DIMENSIONS AND VALUES**  
**DIMENSIONS ET VALEURS**

REF. FAE									INFORMACIÓN TÉCNICA TECHNICAL INFORMATION INFORMATION TECHNIQUE				REF. FAE
	L1 mm.	L2 mm.	L3 mm.	LT mm.	A mm.	H mm.	B mm.	Ø mm.	A Nm.	B Nm.	V	SEG. SEC.	
74140	14,2	32,0	24,5	70,7	M 5	12	12x125	6	≤ 4	15÷25	11	< 6	74140
74141	14,2	26,0	20,0	60,2	M 5	12	12x125	6	≤ 4	15÷25	11	< 6	74141
74142	13,2	32,0	20,0	65,2	M 4	12	12x125	5	≤ 2,5	15÷25	11	< 6	74142
74143	14,2	32,0	28,5	74,7	M 5	12	12x125	6	≤ 4	15÷25	11	< 6	74143
74144	14,2	32,0	22,0	68,2	M 5	12	12x125	6	≤ 4	15÷25	11	< 6	74144
74145	21,2	46,0	24,0	91,2	Ø 4	10	10x100	5	---	10÷15	11	< 6	74145
74146	13,2	27,0	25,0	65,2	M 4	12	12x125	5	≤ 2,5	15÷25	11	< 6	74146
74147	25,0	67,5	27,5	120,0	Ø 5	10	12x125	6	---	15÷25	11	< 6	74147
74148	29,5	26,0	20,5	76,0	Ø 4	12	12x125	6	---	15÷25	11	< 6	74148
74149	21,0	67,5	27,5	116,0	Ø 4	10	12x125	6	---	15÷25	11	< 6	74149
74150	13,5	42,0	24,5	80,0	M 4	10	10x100	5	≤ 2,5	10÷15	11	< 6	74150
74151	13,5	46,0	29,5	89,0	M 4	10	10x100	5	≤ 2,5	10÷15	11	< 6	74151
74152	21,5	46,0	29,5	97,0	Ø 4	10	10x100	5	---	10÷15	11	< 6	74152
74153	13,5	46,0	24,5	84,0	M 4	10	10x100	5	≤ 2,5	10÷15	11	< 6	74153
74154	20,5	37,0	27,5	85,0	Ø 4	12	12x125	5	---	15÷25	11,5	< 6	74154
74155	13,5	81,0	28,5	123,0	M 4	10	10x100	5	≤ 2,5	10÷15	11	< 6	74155
74156	15,0	57,0	24,5	95,0	M 4	10	10x100	5	≤ 2,5	10÷15	11	< 6	74156
74157	20,5	80,0	27,5	128,0	Ø 4	10	10x100	5	---	10÷15	11,5	< 6	74157
74158	29,2	26,0	28,5	83,7	Ø 4	12	12x125	6	---	15÷25	12	< 6	74158
74159	13,2	50,0	16,5	79,7	M 4	12	10x125	5	≤ 2,5	10÷20	11	< 6	74159
74160	14,5	32,0	17,5	64,0	M 5	12	12x125	6	≤ 4	15÷25	11	< 6	74160
74161	14,5	27,0	24,5	66,0	M 5	12	12x125	6	≤ 4	15÷25	11	< 6	74161
74162	17,5	32,0	24,5	74,0	M 4	12	12x125	5	≤ 2,5	15÷25	11	< 6	74162
74163	13,5	38,0	24,5	76,0	M 4	10	10x100	5	≤ 2,5	10÷15	11	< 6	74163
74164	21,2	61,0	24,0	106,2	Ø 4	10	10x100	5	---	10÷15	11	< 6	74164
74165	17,5	53,0	24,5	95,0	M 4	10	10x100	5	≤ 2,5	10÷15	11	< 6	74165
74166	27,0	46,0	32,0	105,0	Ø 4	10	10x100	5	---	10÷15	11	< 6	74166
74167	17,5	63,5	27,5	109,0	M 4	10	10x100	5	≤ 2,5	10÷15	11	< 6	74167
74168	26,5	77,0	28,5	132,0	Ø 4	10	10x100	5	---	10÷15	11	< 6	74168
74169	13,0	52,0	22,0	87,0	M 4	12	10x125	5	≤ 2,5	10÷20	11	< 6	74169
74170	13,2	50,0	18,8	82,0	M 4	12	10x125	5	≤ 2,5	10÷20	11	< 6	74170
74171	12,5	43,5	32,0	88,0	M 4	12	10x125	5	≤ 2,5	10÷20	11	< 6	74171
74172	18,0	53,0	27,0	98,0	M 4	12	10x125	5	≤ 2,5	10÷20	11	< 6	74172
74173	18,0	45,0	22,0	85,0	M 4	12	10x125	5	≤ 2,5	10÷20	11	< 6	74173
74174	21,5	70,0	34,0	125,5	Ø 4	10	10x100	5	---	10÷15	12	< 6	74174
74175	13,5	48,5	24,0	86,0	M 4	12	10x125	5	≤ 2,5	10÷20	11	< 6	74175
74176	13,7	33,5	18,8	66,0	M 4	12	10x125	5	≤ 2,5	10÷20	11	< 6	74176
74177	13,0	53,0	28,0	94,0	M 4	12	10x125	5	≤ 2,5	10÷20	24	< 6	74177
74178	13,5	48,5	18,0	80,0	M 4	12	10x125	5	≤ 2,5	10÷20	11	< 6	74178
74180	17,5	70,0	33,5	121,0	M 4	10	10x100	5	≤ 2,5	10÷15	11	< 6	74180
74181	13,0	83,0	26,5	122,5	M 4	10	10x100	5	≤ 2,5	10÷15	11	< 6	74181
74182	13,0	53,0	18,0	84,0	M 4	12	10x125	5	≤ 2,5	10÷20	11	< 6	74182
74183	17,7	96,0	35,0	148,7	M 4	10	10x100	5	≤ 2,5	10÷20	11,5	< 6	74183
74184	13,2	49,5	21,5	84,2	M 4	12	10x125	5	≤ 2,5	10÷20	6,5	< 20	74184
74185	21,0	47,5	21,5	90,0	M 4	12	10x125	5	≤ 2,5	10÷15	6,5	< 20	74185
74186	13,2	62,5	18,5	94,2	M 4	12	10x125	5	≤ 2,5	10÷20	11	< 6	74186
74187	13,2	34,5	17,0	64,7	M 4	12	10x125	5	≤ 2,5	10÷20	24	< 6	74187
74188	13,5	33,5	17,0	64,0	M 4	12	10x125	5	≤ 2,5	10÷20	11	< 6	74188
74189	21,5	57,0	24,5	103,0	Ø 4	10	10x100	5	---	10÷15	11	< 6	74189
74190	21,2	105,0	24,0	150,2	Ø 4	10	10x100	5	---	10÷15	11	< 6	74190
74191	21,2	53,0	24,5	98,7	Ø 4	10	10x100	5	---	10÷15	11	< 6	74191
74192	23,2	80,0	27,5	130,7	Ø 4	10	10x100	5	---	10÷15	11,5	< 6	74192
74193	13,2	39,0	16,0	68,2	M 4	12	10x125	5	≤ 2,5	10÷20	10,5	< 6	74193
74194	15,5	55,0	24,5	95,0	M 4	10	10x100	5	≤ 2,5	10÷20	10	< 6	74194
74195	27,0	93,0	24,0	144,0	Ø 4	12	10x125	5	---	10÷20	11	< 6	74195
74196	21,0	77,0	31,0	129,0	Ø 4	10	10x100	5	---	10÷15	11	< 6	74196
74197	19,3	33,7	27,0	80,0	8,3	10	10x100	5	---	10÷15	6	< 20	74197
74198	20,6	27,7	29,0	77,3	6,35	10	10x100	5	---	10÷15	11	< 6	74198
74199	19,9	33,7	27,0	80,6	6,35	10	10x100	5	---	10÷15	11	< 6	74199
74200	19,0	33,7	27,0	79,7	6,35	10	10x100	5	---	10÷15	11,5	< 6	74200
74201	21,0	33,7	27,0	81,7	Ø 4	10	10x100	5	---	10÷15	6	< 20	74201
74204	27,0	77,0	30,0	134,0	Ø 4	10	10x100	5	---	10÷15	11	< 6	74204
74206	16,0	82,5	29,5	128,0	M 4	10	10x100	5	≤ 2,5	10÷15	11,5	< 6	74206
74207	14,0	50,0	16,0	80,0	M 4	12	10x125	5	≤ 2,5	10÷20	11	< 6	74207
74208	18,5	47,0	18,5	84,0	M 4	12	10x125	3,5	≤ 2,5	15÷20	11	< 6	74208
74209	22,3	60,0	29,7	112,0	M 4	10	10x100	5	≤ 2,5	10÷15	11	< 6	74209
74210	16,5	75,0	27,0	118,5	M 4	10	10x100	5	≤ 2,5	10÷15	11	< 6	74210

**IMPORTANTE:**

Al pedir accesorios eléctricos, rogamos completen la referencia comenzando por 'F' (ejemplo: 381394 → F381394)

Pour commander accessoires électriques, nous vous prions de compléter la référence en commençant par 'F'.

When ordering electric accessories, please complete the reference by beginning with 'F'.



## ACCESORIOS ELÉCTRICOS

## ACCESSOIRES ELECTRIQUES / ELECTRIC ACCESSORIES



INFORMACIÓN TÉCNICA  
TECHNICAL INFORMATION  
INFORMATION TECHNIQUE



## INFORMACIÓN TÉCNICA

## FUNCIÓN DEL CALENTADOR

Con la introducción del motor Diesel en los vehículos, surgió pronto un gran inconveniente. Efectivamente, en los motores Diesel, cuyo arranque espontáneo se supedita a altas temperaturas de combustión (aproximadamente 750 ° C.) por efecto de la compresión, se crea una imposibilidad de arranque cuando las condiciones son adversas por efecto de las bajas temperaturas, tanto del motor, como del aire frío que éste aspira y en el que sólo se consigue el arranque con un calor adicional.

Es a través del calentador como se aporta ese calor adicional necesario para lograr un fácil arranque; un arranque en el que día a día disminuye el tiempo necesario para la puesta en marcha. Ello es posible gracias a nuevos materiales y al avance de la tecnología en este campo, teniendo hoy día como norma un precalentamiento de entre 3-7 segundos, los cuales normalmente son temporizados por una centralita electrónica, que por medio de una sonda o sensor térmico instalado en el motor, adecúan en función de la temperatura de este último, el tiempo preciso de calentamiento para un arranque sin problemas.

## CARACTERÍSTICAS Y EVOLUCIÓN

El calentador actual consta de tres partes importantes: la principal es el tubo calefactor, de una aleación especial, para soportar altas temperaturas y el deterioro producido por efectos de la combustión. Dentro del tubo va introducida una resistencia que reúne unas características determinadas, protegida por un aislante fuertemente compactado que la rodea y que determina la rapidez de incandescencia y su duración.

La segunda parte es el cuerpo roscado para su ensamblaje en el motor. La tercera parte es el conector por el cual alimentamos eléctricamente el calentador.

Una vez montado el calentador en el motor, es el extremo del tubo calefactor el que asoma a la cámara de precombustión, turbulencia o en el cilindro en motores de inyección directa, el que con su incandescencia superior a 850 ° C., hace inflamarse la mezcla de combustible y prepara el motor para un arranque perfecto.

En la actualidad, en gran parte del parque de vehículos Diesel, se está introduciendo, por sus grandes ventajas, el calentador de post-calentamiento. Este modelo de calentador, de parecido aspecto al de sus predecesores, tiene, aparte de su misión de precalentamiento para el arranque, la de mantener encendido el calentador hasta 3 ó 4 minutos después de la puesta en marcha, consiguiendo hacer desaparecer los humos blancos-azules de los arranques tradicionales, con graves efectos de contaminación. Se consigue también que en esos primeros instantes, el motor gire con mucha suavidad y desaparezca el antiguo y desagradable «repiqueo» del motor en los primeros minutos de la puesta en marcha, aparte de la eliminación de carbonilla por la buena combustión que proporciona el calentamiento adicional (post-calentamiento).



## TIPOS DE CÁMARAS DE COMBUSTIÓN

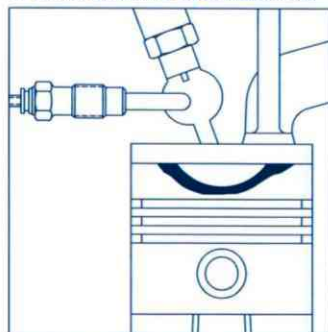

PRE COMBUSTIÓN

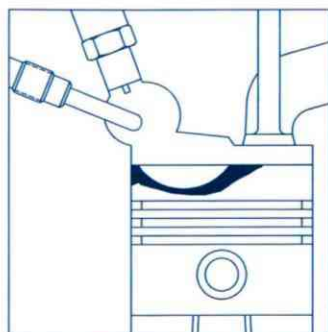

TURBULENCIA

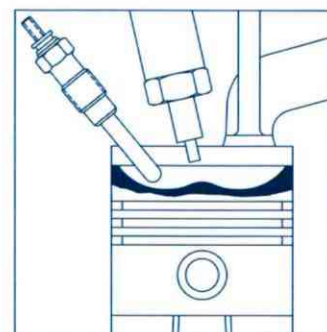

INYECCIÓN DIRECTA

## MONTAJE DE NUEVOS CALENTADORES

Al montar calentadores nuevos, asegúrese de que las dimensiones y la tensión sean idénticas a la de los originales. El montaje de calentadores con características diferentes a los originales, conlleva riesgo de daños para el motor. Cada tipo de calentador es específico a un tipo de motor.

Así pues, tanto la longitud del tubo calefactor como el ensamblaje del cuerpo, determinan el perfecto alojamiento del calentador y su zona de incandescencia en el lugar preciso previsto por el constructor. Todas las funciones de temporización, tanto de precalentamiento como de post-calentamiento, vienen programadas por la centralita electrónica que en origen montan los vehículos.

Tener en cuenta que al efectuar la sustitución de los Calentadores, los nuevos han de ser montados con la herramienta adecuada que permita controlar el par de apriete.

En caso de duda, si en el momento de efectuar un nuevo montaje o repuesto, encuentra alguna anomalía, recuerde que nuestro servicio técnico le podrá asesorar para garantizar su buen uso.

**ACCESORIOS ELÉCTRICOS**
**ACCESSOIRES ELECTRIQUES / ELECTRIC ACCESSORIES**

**INFORMACIÓN TÉCNICA**  
**TECHNICAL INFORMATION**  
**INFORMATION TECHNIQUE**

**TECHNICAL INFORMATION**
**GLOW PLUG OPERATION**

A serious disadvantage soon appeared following the introduction of diesel engines in vehicles. Diesel engines require high combustion temperatures (approximately 750 ° C) to start. The effects of compression make starting impossible under adverse conditions caused by low temperatures. The cold engine in combination with the cold air it makes start-up possible only with the addition of heat.

Glow plug provide the additional heat necessary for easy engine starting, with the time required for this to occur being reduced day to day. This is possible thanks to new materials and advanced technology in this area. As a rule, pre-heating time today is between 3-7 seconds and is usually timed by an electronic control panel which uses a thermal sensor or probe installed in the engine to measure engine temperature and adjust the heating time needed for flawless starting.

**CHARACTERISTICS AND EVOLUTION**

Glow plugs are currently composed of three important parts. The main part is the heating pipe which is made of a special alloy to withstand high temperatures and the deterioration produced by the effects of combustion. Inside the pipe there is a special resistance protected by highly compact insulation which surrounds the pipe and determines the rapidity and duration of incandescence.

The second part is a threaded body for attaching the glow plug to the engine. The third part is the connector which feeds electrical current to the glow plug.

Once the glow plug is mounted on the engine, the end of the heating pipe extends into the pre-combustion chamber or combustion chamber, or the cylinder in direct injection engines. With incandescence above 850 ° C, it ignites the fuel and prepares the engine for perfect starting.

At present, post-heating glow plugs are being introduced in a great number of Diesel vehicles due to the advantages they offer. In addition to pre-heating prior to engine starting, this type of glow plug, which looks similar to its predecessors, keeps the glow plug running for 3 or 4 minutes following start-up, eliminating the highly contaminating bluish-white fumes traditionally given off during start-up. This type of glow plug allows the engine to turn much more smoothly and eliminates that annoying "clattering" of the engine in the first few minutes after starting. Coal dust is also eliminated thanks to efficient the combustion provided by the additional heatin (post-heating).

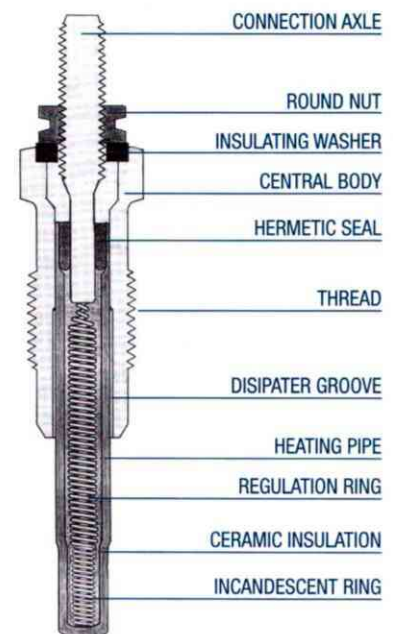
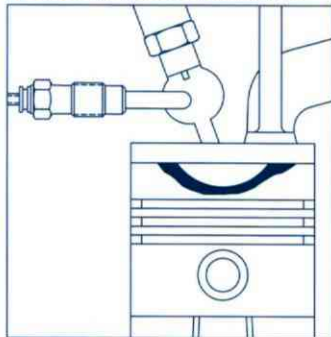
**TYPES OF COMBUSTION CHAMBERS**

PRE COMBUSTION

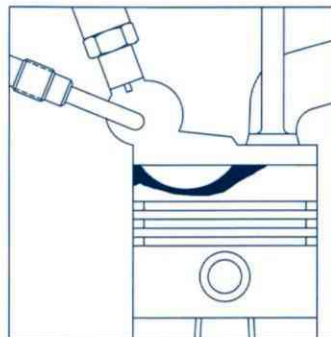

TURBULENCE

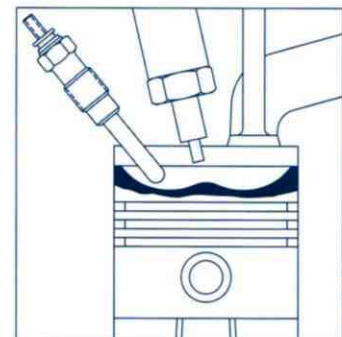

DIRECT INJECTION

**INSTALLING THE NEW GLOW PLUG**

When installing new glow plugs, make sure that the dimensions and voltage are the same as the original ones. Installing glow plugs with diferent characteristics than the original ones may damage the engine. Each glow plug is specific to a certain type of engine.

The length of the heating pipe and the body assembly will determine the perfect fit of the glow plug and its area of incandescence in the exact spot envisaged by the manufacturer. All pre-heating and post-heating timing functions are programmed in the electronic control panel originally installed in the vehicle.

Remember that when replacing glow plugs the new ones must be installed with a suitable tool to control the tightening torque.

If you have any doubts or encounter anomalies when replace a glow plug, remember that our technical service department is at your service to help you.



## ACCESORIOS ELÉCTRICOS

## ACCESSOIRES ELECTRIQUES / ELECTRIC ACCESSORIES



INFORMACIÓN TÉCNICA  
TECHNICAL INFORMATION  
INFORMATION TECHNIQUE

## INFORMATION TECHNIQUE

### FONCTION DE LA BOUGIE DE PRÉCHAUFFAGE

Avec l'introduction du moteur Diesel dans les véhicules, un important inconvénient est rapidement apparu. Effectivement, dans les moteurs Diesel, dont le démarrage immédiat est subordonné à des hautes températures de combustion (approximativement 750 ° C), du fait de la compression, il se produit une impossibilité de démarrage lorsque les conditions sont contraires à cause des températures trop basses aussi bien du moteur lui-même que de l'air froid que celui-ci aspire. Le démarrage ne peut donc être obtenu qu'avec une chaleur supplémentaire.

C'est grâce au bougie de préchauffage que l'on peut apporter cette chaleur supplémentaire indispensable à un démarrage facile; un démarrage pour lequel le temps nécessaire diminue chaque jour un peu plus. Ceci est devenu possible grâce à des nouveaux matériaux ainsi qu'aux progrès de la technologie dans ce domaine. La norme actuelle est, en effet, d'obtenir un préchauffage de 3 à 7 secondes, qui sont normalement établies par une centrale électronique. Cette centrale, au moyen d'une sonde ou d'un capteur thermique installé dans le moteur, met en adéquation, en fonction de la température du moteur lui-même, le temps précis de préchauffage permettant un démarrage sans problèmes.

### CARACTÉRISTIQUES ET ÉVOLUTION

La bougie de préchauffage actuel comprend trois parties importantes. La principale de ces parties est le tube de chauffage, fabriqué en alliage spécial, à fin de supporter des hautes températures ainsi que les risques de détérioration produits par les effets de la combustion. A l'intérieur du tube est introduite une résistance qui possède des caractéristiques déterminées. Cette résistance est protégée par un isolant très compact qui l'entoure et qui détermine, en même temps, sa rapidité d'incandescence et sa durée. La deuxième partie est le corps à filetage pour son assemblage dans le moteur. Enfin, la troisième partie est le connecteur par lequel la bougie de préchauffage est alimentée en électricité.

Une fois la bougie de préchauffage monté sur le moteur, c'est l'extrémité du tube de la bougie de préchauffage qui pointe dans la chambre de précombustion, de turbulence ou dans le cylindre des moteurs à injection directe. C'est lui qui, grâce à son incandescence supérieure à 850 ° C, permet l'inflammation du mélange du combustible et prépare le moteur pour un démarrage parfait.

En l'actualité, la bougie de préchauffage de post-chauffage est introduite dans une grande partie du parc de véhicules à moteur Diesel, du fait de ses grands avantages. Ce modèle de bougie de préchauffage, qui a un aspect semblable à ses prédécesseurs, a, en plus de sa fonction de préchauffage pour le démarrage, la fonction de maintenir allumé le chauffage pendant trois ou quatre minutes après la mise en marche, ce qui permet de faire disparaître ces fumées blanches-bleutées des démarrages traditionnels qui ont de graves effets de pollution. Cela permet aussi d'obtenir, au cours de ces premiers instants de fonctionnement, que le moteur tourne avec plus de douceur et, par conséquent, de faire disparaître les anciens et désagréables "broutages" du moteur. Cela permet enfin d'éliminer les éléments de carbone qui empêchent la bonne combustion que procure le chauffage additionnel (post-chauffage).

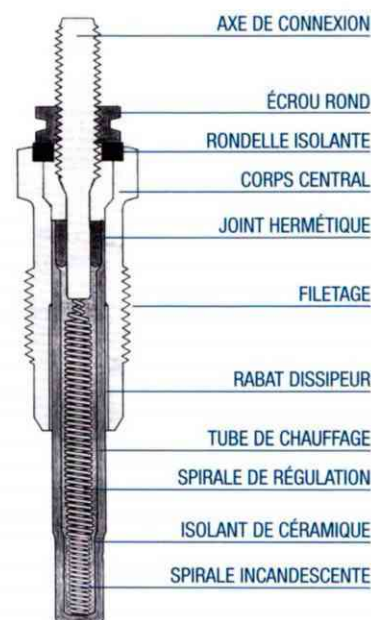

### TYPES DE CHAMBRES DE COMBUSTION

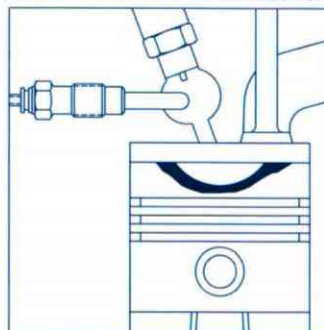

PRE-COMBUSTION

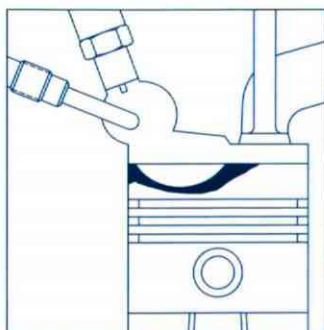

TURBULENCE

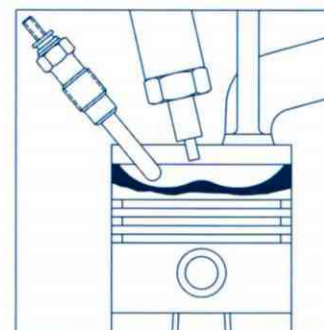

INJECTION DIRECTE

### MONTAGE DE BOUGIES DE PRÉCHAUFFAGE NEUFS

En montant des bougies de préchauffages neufs, s'assurer que les dimensions et la tension sont bien les mêmes que ceux des bougies de préchauffage d'origine. En effet, le montage de bougies de préchauffage ayant des caractéristiques différentes entraîne des risques de dommages pour le moteur. Chaque type de bougie de préchauffage est spécifique d'un type de moteur.

En effet, aussi bien la longueur du tube réchauffeur que l'assemblage du corps déterminent le parfait logement du réchauffeur et sa zone d'incandescence à l'endroit précis prévu par le constructeur. Toutes les fonctions de détermination de la durée, aussi bien de préchauffage que de post-chauffage, sont programmées par la centrale électronique qui est montée à l'origine sur les véhicules.

Ne pas oublier qu'en effectuant la substitution des bougies de préchauffage, les nouveaux doivent être montés avec l'outillage adéquat qui permet de contrôler le couple de serrage.

En cas de doute, si au moment d'effectuer le montage des bougies de préchauffage vous constatez des anomalies, n'oubliez pas que notre service technique reste à votre disposition pour vous conseiller afin de garantir un bon usage de nos produits.

**INFORMACIÓN TÉCNICA  
TECHNICAL INFORMATION  
INFORMATION TECHNIQUE**
**CAUSAS DEL FALLO**

Compruebe los calentadores si el motor no arranca o lo hace con dificultad, expulsando humo blanco-azulado por el tubo de escape.

Como medida preventiva, al cambiar un calentador, realice el cambio del resto de calentadores.

La inspección de los calentadores sustituidos, es en gran parte, un indicador del estado del motor y su funcionamiento.

- 1.- - Rotura de las válvulas.  
- Aros que dejan pasar el aceite a la cámara de combustión.  
- Pistones que se agarrotan (gripaje).
- 2.- - Incidencia de la inyección sobre el tubo calefactor. Fallo en la aspersion del inyector.
- 3.- - Apriete excesivo del conector.
- 4.- - Aceite en el calentador y apriete defectuoso, ya que el cono del calentador no ha hecho la función de cierre hermético.
- 5.- - Defecto de inyección. Tarado incorrecto.
- 6.- - Sobretensión. Calentamiento prolongado.
- 7.- - Muecas en el cuerpo hexagonal por utilización de una llave inadecuada.
- 8.- - Tiempo excesivo de calentamiento.
- 9.- - Calibración defectuosa en la aspersion del inyector.
- 10.- - Entrada de aceite en la cámara de combustión.  
- Calibración defectuosa o adelanto en la inyección.

**CAUSES OF FAILURE**

Check the glow plugs if the engine does not start or starts with difficulty, giving off a bluish-white smoke through the exhaust pipe. As a preventive measure, when changing one glow plug change the rest of them as well.

Inspecting the replaced glow plugs is a way to know the condition of the engine and its operation.

- 1.- - Broken valves.  
- Arcs through which oil flows to the combustion chamber.  
- Pistons that grip up.
- 2.- - Injection incidence on the heating pipe. Failure in the injection aspersion.
- 3.- - Excessive connector tightness.
- 4.- - Oil in the glow plug and defective tightness due to the glow plug cone not being hermetically sealed.
- 5.- - Defective injection. Incorrect measurement.
- 6.- - Overvoltage. Prolonged heating.
- 7.- - Notches in the hexagonal body caused by using the wrong spanner.
- 8.- - Excessive heating time.
- 9.- - Defective calibration of injector aspersion.
- 10.- - Oil entering the combustion chamber.  
- Defective calibration or premature injection.

**CAUSE DE PANNES**

Vérifier les bougies de préchauffage si le moteur ne démarre pas ou le fait avec difficulté, en expulsant une fumée blanche-bleutée par le tuyau d'échappement. Comme mesure préventive, lors du changement d'une bougie de préchauffage, changer aussi les autres.

L'inspection des bougies de préchauffage substitués est, pour une bonne part, un indicateur de l'état du moteur et de son fonctionnement.

- 1.- - Rupture de vannes.  
- Bagues qui laissent passer l'huile dans la chambre de combustion.  
- Pistons qui se coincent (grippage).
- 2.- - Incidence de l'injection sur le tube de préchauffage. Panne de l'aspersion de l'injecteur.
- 3.- - Serrage excessif du connecteur.
- 4.- - Huile dans la bougie de préchauffage et serrage defectueux, étant donné que le cône de la bougie de préchauffage n'a pas rélisé la fonction de fermeture hermétique.
- 5.- - Défaut d'injection. Réglage incorrect.
- 6.- - Surtension. Préchauffage prolongé.
- 7.- - Encoche dans le corps hexagonal du fait de l'utilisation d'une clé inadéquate.
- 8.- - Temps excessif de préchauffage.
- 9.- - Calibrage defectueux de l'aspersion de l'injecteur.
- 10.- - Entrée d'huile dans la chambre de combustion.  
- Calibrage defectueux ou avance de l'injection.





## ACCESORIOS ELÉCTRICOS

## ACCESSOIRES ELECTRIQUES / ELECTRIC ACCESSORIES



CALENTADORES - TERMOPLUS  
TERMOPLUS - GLOW PLUGS  
BOUGIES DE PRÉCHAUFFAGE - TERMOPLUS

74000



## EXPOSITOR TERMOPLUS EUROPEO

El Expositor completo Ref. FAE 74000, está compuesto por 64 unidades, desglosadas con las siguientes Referencias:

- Ref. FAE 74140 : 28 unidades.
- Ref. FAE 74141 : 8 unidades.
- Ref. FAE 74142 : 8 unidades.
- Ref. FAE 74144 : 8 unidades.
- Ref. FAE 74145 : 4 unidades.
- Ref. FAE 74146 : 8 unidades.



## EUROPEAN TERMOPLUS EXHIBITOR

The complete exhibitor part number FAE 74000 is composed by 64 pcs as follows:

- p/n. FAE 74140 : 28 pcs.
- p/n. FAE 74141 : 8 pcs.
- p/n. FAE 74142 : 8 pcs.
- p/n. FAE 74144 : 8 pcs.
- p/n. FAE 74145 : 4 pcs.
- p/n. FAE 74146 : 8 pcs.

74001



## EXPOSITOR TERMOPLUS JAPONES

El Expositor completo Ref. FAE 74001, está compuesto por 64 unidades, desglosadas con las siguientes Referencias:

- Ref. FAE 74159 : 12 unidades.
- Ref. FAE 74169 : 16 unidades.
- Ref. FAE 74171 : 12 unidades.
- Ref. FAE 74172 : 12 unidades.
- Ref. FAE 74173 : 12 unidades.



## JAPANESE TERMOPLUS EXHIBITOR

The complete exhibitor part number FAE 74001 is composed by 64 pcs as follows:

- p/n. FAE 74159 : 12 pcs.
- p/n. FAE 74169 : 16 pcs.
- p/n. FAE 74171 : 12 pcs.
- p/n. FAE 74172 : 12 pcs.
- p/n. FAE 74173 : 12 pcs.



## EXPOSEUR TERMOPLUS EUROPÉEN

L'exposeur complet Référence FAE 74000 est composé par 64 pièces comme il suit:

- Réf. FAE 74140 : 28 pièces.
- Réf. FAE 74141 : 8 pièces.
- Réf. FAE 74142 : 8 pièces.
- Réf. FAE 74144 : 8 pièces.
- Réf. FAE 74145 : 4 pièces.
- Réf. FAE 74146 : 8 pièces.



## EXPOSEUR TERMOPLUS JAPONAIS

L'exposeur complet Référence FAE 74001 est composé par 64 pièces comme il suit:

- Réf. FAE 74159 : 12 pièces.
- Réf. FAE 74169 : 16 pièces.
- Réf. FAE 74171 : 12 pièces.
- Réf. FAE 74172 : 12 pièces.
- Réf. FAE 74173 : 12 pièces.



## IMPORTANTE:

Al pedir accesorios eléctricos, rogamos completen la referencia comenzando por 'F' (ejemplo: 381394 → F381394)

Pour commander accessoires électriques, nous vous prions de compléter la référence en commençant par 'F'.

When ordering electric accessories, please complete the reference by beginning with 'F'.

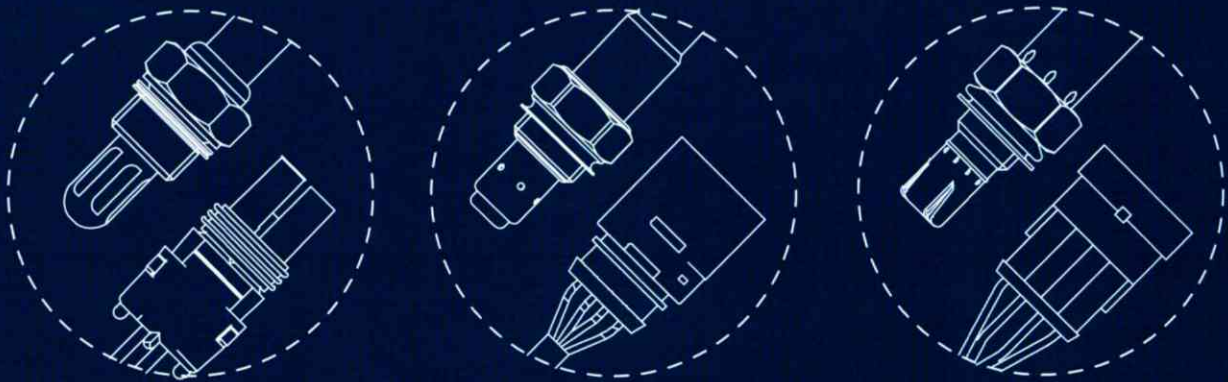

**SONDAS LAMBDA**  
**OXYGEN SENSORS**  
**SONDES LAMBDA**



## ACCESORIOS ELÉCTRICOS

## ACCESSOIRES ELECTRIQUES / ELECTRIC ACCESSORIES



SONDAS LAMBDA UNIVERSALES  
UNIVERSAL OXYGEN SENSORS  
SONDES LAMBDA UNIVERSELLES

### REF. FAE

Adaptable a / Suitable to / Remplace à

FABRICANTE		MAKER		CONSTRUCTEUR	
Modelos	Años	Model	Year	Modèle	Année

250 mm  
LONGITUD / LENGHT / LONGEUR

REEMPLAZA / REPLACES / REMPLACE :  
Códigos Originales / OEM P/Nrs. / Réf. d'origine

FIJACIÓN THREAD FIXATION	4 Zr	ESQUEMA SCHEME SCHEMA	CONEXIÓN CONNECTION CONNEXION
--------------------------------	---------	-----------------------------	-------------------------------------

### SIMBOLOS - SYMBOLS - SYMBOLES



Aplicaciones por vehículos  
Vehicle application  
Applications pour véhicules



Motor  
Engine  
Moteur



Año  
Year  
Année



Información  
Information  
Information



Sondas Lambda Especificas  
Specific Oxygen Sensors  
Sondes Lambda Spécifiques



Sondas Lambda Universales  
Universal Oxygen Sensors  
Sondes Lambda Universelles



Cruce de Referencias  
Cross References  
Tableau des equivalences



Fijación y Rosca  
Thread  
Fixation et Fillet



Llave  
Wrench  
Clé



Nº de cables  
Nr. of wires  
Nº de câbles



Circonio  
Zirconia  
Zirconium



Titanio  
Titania  
Titane

### ESQUEMA ELÉCTRICO / ELECTRICAL SCHEME / SCHEMA ELECTRIQUE



1 Cables.  
1-wire.  
1 fil.



2 Cables. Aislado masa.  
2-wire. Isolated ground.  
2 fils. Isolé au masse.



2 Cables. Con masa chasis.  
2-wire. Case/body ground.  
2 fils. Masse au chasis.



3 Cables.  
3-wire.  
3 fils.



4 Cables. Aislado masa.  
4-wire. Isolated ground.  
4 fils. Isolé au masse.



4 Cables. Con masa chasis.  
4-wire. Case/body ground.  
4 fils. Masse au chasis.

### LONGITUDES / LENGHT / LONGEURS

Longitud en mm. de cada cable  
medido de la forma ilustrada:

Length in mm. of single lead  
measured as shown:

Longeur en mm. de chaque fil  
mesuré comme suit:

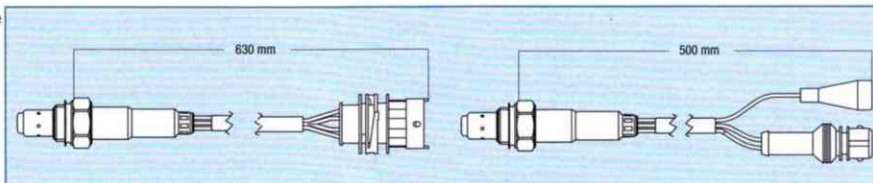

Para identificar una Sonda Lambda de un modelo específico, consultar Aplicaciones por Vehículos. Las piezas contenidas en este Catálogo, pueden estar sujetas a modificaciones dimensionales o de material, sin previo aviso. Todas las unidades de medida expresadas en este Catálogo son en milímetros. Los pares de apriete están en Newton por metro.

Refer to Vehicle Applications to trace the Oxygen sensor of a specific model. The parts shown in this Catalogue, are subject to modification in design or material without notice.

All measurement units started on this Catalogue are in millimeters. Torques are in Newton by meter.

Pour trouver un modele spécifique d'une Sonde Lambda, consulter les Applications par Vehicules. Les pièces contenues dans ce Catalogue, peuvent être modifiées en matériel ou exécution sans préavis. Toutes les unités de mesure indiquées sur ce Catalogue sont en millimetres. La couple de serrage sont en Newton par metre.

### IMPORTANTE:

Al pedir accesorios eléctricos, rogamos completen la referencia comenzando por 'F' (ejemplo: 381394 → F381394)

Pour commander accessoires électriques, nous vous prions de compléter la référence en commençant par 'F'.

When ordering electric accessories, please complete the reference by beginning with 'F'.

## ACCESORIOS ELÉCTRICOS

### ACCESSOIRES ELECTRIQUES / ELECTRIC ACCESSORIES



#### SONDAS LAMBDA ESPECIFICAS SPECIFIC OXYGEN SENSORS SONDES LAMBDA SPECIFIQUES

### 77105

Adatt. Universal 77003

PEUGEOT	
505 2.0i (XN6)	1985-87
505 2.2i, GTI, Turbo	1984-93

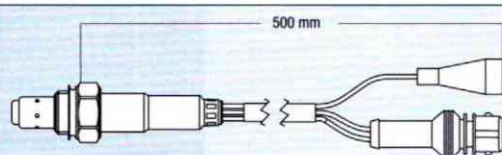
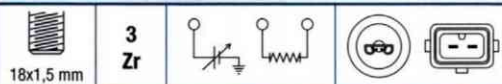
 Reemplaza/Suitable: **Bosch** 0258 003 164, 0258 003 508, 510  
**NTK** OZA446-E11, OZA446-E12

### 77126

Adatt. Universal 77008

CITROEN		PEUGEOT	
AX 1.4i, 1.4i Cat. ->N6629	1991-95	106 1.0i (TU9M)	1992-95
AZ 1.4 GTI ->N°.6629	1991-95	106 1.1i (TU1M)	1991-95
Xantia 1.6i ->N°.6679	1993-95	106 1.3i (TU2J2)	1993-95
Xantia 1.8i, 1.8i Cat., Break	1993-95	106 1.4i, 1.4i Cat.	1991-95
Xantia 2.0i, 2.0i Cat., Break	1993-95	106 1.4i XSI (TU3J)	1991-95
ZX 1.4i (TU3MZ)	1991-95	106 1.6i (TU5J2)	1994-95
		106 1.6i (TU5JP)	1993-95
		306 1.1i	1993-95
		306 1.4i	1993-95
		306 1.6i	1993-95

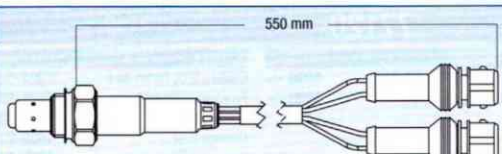
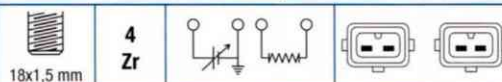
 Reemplaza/Suitable: **Bosch** 0258 003 239, 0258 003 567  
**NTK** OZA527-E2, OZA527-E12

### 77127

Adatt. Universal 77008

CITROEN		CITROEN Cont.		PEUGEOT	
AX 1.0i, 1.0i Cat.	1992-95	ZX 1.8i Cat. ->N.6748	1992-95	Boxer 2.0i ->Ch.15267330	1994-95
AX 1.1i Cat. N.5293->6629	1991-95	ZX 1.9i Cat. ->N.6748	1991-95	306 1.8i Cat.	1993-95
AX 1.4i Cat. N.5293->6629	1991-95	ZX 2.0i, 2.0i Cat. ->N.6748	1992-95	306 2.0i, 2.0i Cat.	1993-95
C15E 1.1i Cat. N.5657-6743	1992-96	ZX 2.0i 16V ->N.6748	1992-95	306 2.0i 16V	1993-95
C15E 1.4i Cat. N.5657-6743	1992-96			405 1.4i Cat.	1992-95
Jumper 2.0i ->Ch.1526733	1994-95			405 1.6i Cat.	1992-95
Xantia 2.0i 16V, VSX, Break	1993-95			405 1.8i Cat.	1992-95
XM 2.0i, Break	1991-94			405 2.0i, 2.0i Cat.	1992-95
XM 2.0i Turbo, Break	1992-94			405 2.0i MI16	1993-95
ZX 1.1i Cat. ->N.6808	1992-95			605 2.0i, 2.0i Cat.	1991-94
ZX 1.4i Cat. ->N.6748	1992-95			605 2.0i Turbo	1992-94
ZX 1.6i Cat. ->N.6748	1992-95				

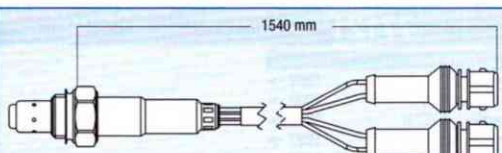
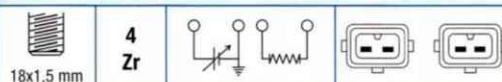
 Reemplaza/Suitable: **Bosch** 0258 003 203, 0258 003 391  
**NTK** OZA527-E3

### 77162

Adatt. Universal 77008

CITROEN		PEUGEOT	
Berlingo 1.4i (TU3JP)	1996-00	106 1.0i (TU9M)	1995-96
Saxo 1.1i, X, SX, (TU1M)	1996-00	106 1.1i (TU1M)	1995-96
Saxo 1.4i, VTS, (TU3JP)	1996-00	106 1.3i (TU2J2)	1995-96
Saxo 1.6i, VTL, VTR, (NFZ)	1996-00	106 1.4i, 1.4 XSI	1995-96
XSara 1.4i N° 7729->	1997-00	106 1.6i, 1.6i Cat.	1993-96
XSara 1.6i N° 7729->	1997-00	206 1.1i (TU1JP)	1998-00
XSara Break 1.4i, 1.6i	1998-00	206 1.4i (TU3JP)	1998-00
XSara Coupe 1.4i, 1.6i	1998-00	Partner 1.4i (TU3JP)	1996-00
ZX 1.1i N° 7245 ->	1997-98	Ranch 1.4i (TU3JP)	1996-00
ZX 1.4i, Break	1993-97		

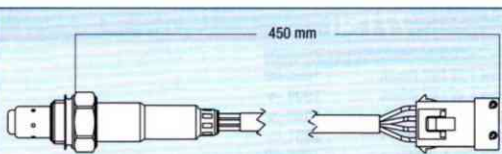
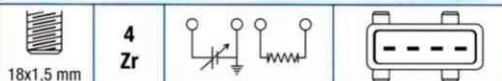
 Reemplaza/Suitable: **Bosch** 0258 003 671  
**NTK** OZA527-E29

### 77163

Adatt. Universal 77008

CITROEN		PEUGEOT	
Saxo 1.4i VTS (CEE2000)	1996-00	106 1.6i 16V (Depol 15-04)	1996-00
XSara 1.4i -> N° 7228	1997-00	306 1.8i, ST, (XU7JP)	1997-00
XSara 1.6i -> N° 7228	1997-00	306 2.0i 16V (Depol 15-04)	1997-00
XSara Break 1.4i, 1.6i	1997-00	306 Break 1.8i, 2.0i	1997-00
XSara Coupe 1.4i, 1.6i	1998-00	306 Cabrio 1.8i, 2.0i	1997-00
		406 3.0i 24V (Depol 15-04)	1996-00
		406 Break 3.0i V6 24V	1997-00
		406 Coupe 3.0i V6 24V	1997-00

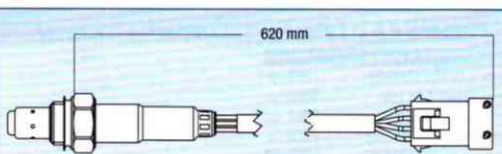
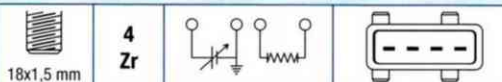
 Reemplaza/Suitable: **Bosch** 0258 003 672, 0258 003 705  
**PSA** 1628.9A, 1628.CP

#### IMPORTANTE:

Al pedir accesorios eléctricos, rogamos completen la referencia comenzando por 'F' (ejemplo: 381394 → F381394)

*Pour commander accessoires électriques, nous vous prions de compléter la référence en commençant par 'F'.*

When ordering electric accessories, please complete the reference by beginning with 'F'.



## ACCESORIOS ELÉCTRICOS

## ACCESSOIRES ELECTRIQUES / ELECTRIC ACCESSORIES



**SONDAS LAMBDA ESPECIFICAS**  
**SPECIFIC OXYGEN SENSORS**  
**SONDES LAMBDA SPECIFIQUES**
**77164**

Adatt. Universal 77008

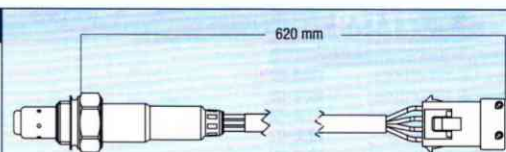
CITROEN		PEUGEOT	
Berlingo 1.8i (LFX)	1997-00	306 1.8i 16V N°7875->	1997-00
Xantia 1.8i, Break. (XU7JP)	1997-00	306 Break 1.8i 16V	1997-00
Xantia 1.8i 16V N°7251->	1995-98	306 Cabrio 1.8i 16V	2000 ->
Xantia 1.8i 16V (CEE95)	1998-00	Partner 1.8i (XU7JB)	1997-00
XSara 1.8i, Break. (XU7JP)	1997-00	Ranch 1.8i (XU7JB)	1997-00
XSara 1.8i 16V, Break	1997-00		
XSara Coupe 1.8i, 1.8i 16V	1998-00		

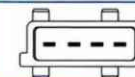
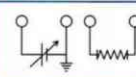

Reemplaza/Suitable: PSA 1628.AA

4  
Zr**77165**

Adatt. Universal 77008

CITROEN		PEUGEOT	
Berlingo 1.4i N°7875->	1997-00	106 1.1i (Depol CEE95)	1995-96
Saxo 1.4i, VTS. 7728->	1996-00	106 1.4i N°7725->	1996-00
XSara 1.4i N°7707->	1997-00	206 1.1i (CEE95 L3)	1998-00
XSara 1.4i Break, Coupe	1998-00	206 1.4i (CEE95 L3)	1998-00
		306 1.4i, SL, Break	1996-00
		406 1.8i, Break. (XU7JB)	1997-00
		406 1.8i 16V N°7330->	1997-00
		Partner 1.4i N°7875->	1997-00
		Ranch 1.4i (TU3JP)	1996-00

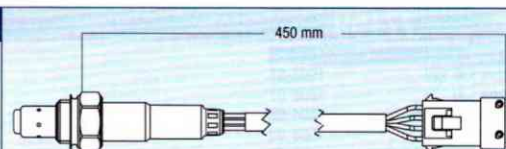

Reemplaza/Suitable: PSA 1628.7R

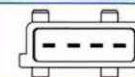
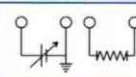
4  
Zr**77166**

Adatt. Universal 77008

CITROEN		PEUGEOT	
Saxo 1.6i 16V (TU5JP)	1996-99	106 1.6i 16V ->N°8364	1996-00
Xantia 1.6i (XUJ5P)	1993-00	306 1.8i 16V ->N°7874	1997-00
Xantia 1.8i N°06780->	1993-98	306 2.0i 16V (RFV)	1997-00
Xantia 1.8i 16V ->N°07250	1995-98	306 Break 1.8i, 2.0i	1997-00
Xantia 2.0i (XU10J2C)	1993-97	306 Cabrio 1.8i, 2.0i	1997-00
Xantia 2.0i Turbo	1995-98	406 1.6i ->N°7083	1995-99
Xantia Break 1.8i, 2.0i	1995-98	406 1.8i (XU7JP)	1995-00
XSara 2.0i 16V, Break	1998-00	406 1.8i 16V ->N°7083	1995-99
		406 2.0i Turbo	1995-99
		406 Break 1.8i, 1.8i 16V	1996-00

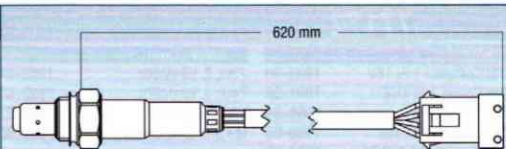
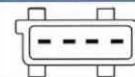
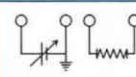
Reemplaza/Suitable: Bosch 0258 003 717  
NTK OZA527-E164  
Zr**77167**

Adatt. Universal 77008

CITROEN		PEUGEOT	
Evasion 1.8i (XU7JP)	1996-02	806 1.8i	1996-02
Evasion 2.0i (XU10J2C)	1994-02	806 2.0i	1994-99
Evasion 2.0i 16V	1998-00	806 2.0i 16V	1998-02
Evasion 2.0i Turbo	1994-02	806 2.0i Turbo	1994-02
Jumper 2.0i	1994-02	Boxer 2.0i, 4x4	1994-02
Jumpy 1.6i	1995-00	Expert 1.6i (SPI)	1996-02
Xantia 2.0i 16V, Break	1995-00		
XM 2.0i 16V, Break	1994-00		
XM 2.0i Turbo, Break	1994-00		

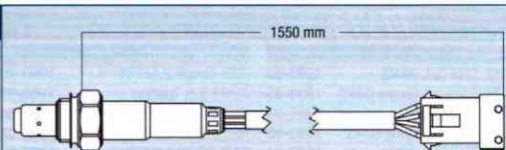
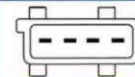
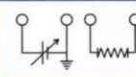
Reemplaza/Suitable: Bosch 0258 003 360, 0258 003 719  
NTK OZA448-E564  
Zr**77240**

Adatt. Universal 77009

CITROEN		PEUGEOT	
Berlingo 1.1i	1996 ->	206 1.1i (CEE2000)	1998 ->
Berlingo 1.4i	1996 ->	206 1.4i (CEE2000)	1998 ->
Berlingo 1.6i 16V	2000 ->	206 1.6i 16V (CEE2000)	2001 ->
C 3 1.1i	2002 ->	206 CC 1.6i 16V	2000 ->
C 3 1.4i	2002 ->	306 1.4 SL, Break	1994 ->
C 3 1.6i 16V	2002 ->	306 1.6i, Break, Cabrio	2000 ->
C 5 3.0i V6, Break	2001 ->	307 1.4i	2000 ->
Saxo 1.1i X, SX (CEE2000)	1996 ->	307 1.6i, 307 SW 1.6i	2000 ->
Saxo 1.4i VTS (CEE2000)	1996 ->	406 3.0i V6, Break, Coupe	2000 ->
Saxo 1.6i VTS (CEE2000)	1996 ->	607 3.0i V6 24V	1996 ->
XSara 1.4i, Break, Coupe	2000 ->	Partner 1.1i, 1.4i	1996 ->
XSara 1.6i 16V, Break	2000 ->	Partner 1.6i 16V	2001 ->

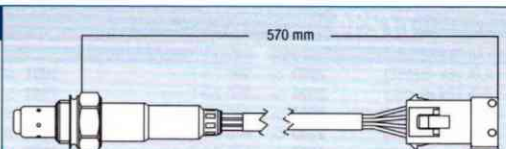
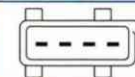
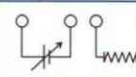
Reemplaza/Suitable: Bosch 0258 006 185  
PSA 1628.KY, 1628.NY4  
Zr**IMPORTANTE:**

Al pedir accesorios eléctricos, rogamos completen la referencia comenzando por 'F' (ejemplo: 381394 → F381394)

Pour commander accessoires électriques, nous vous prions de compléter la référence en commençant par 'F'.

When ordering electric accessories, please complete the reference by beginning with 'F'.

# ACCESORIOS ELÉCTRICOS

## ACCESSOIRES ELECTRIQUES / ELECTRIC ACCESSORIES



**SONDAS LAMBDA ESPECIFICAS**  
**SPECIFIC OXYGEN SENSORS**  
**SONDES LAMBDA SPECIFIQUES**

**77241**
**Adatt. Universal 77009**

CITROEN		PEUGEOT	
C 5 1.8 16V ->N° 08854	2001 ->	206 2.0i 16V (CEE2000)	1999 ->
C 5 2.0 16V ->N° 08854	2001 ->	206 CC 2.0i 16V	2000 ->
C 5 2.0 HPI ->N° 08907	2001 ->	306 1.8i 16V, Break	1997 ->
C 5 Break 16V	2001 ->	306 Cabrio 1.8i 16V	2000 ->
Jumper 2.0i	2002 ->	406 1.8i 16V, Break	2000 ->
		406 2.0 16V HPI	2001 ->
		406 2.2i, Break	2000 ->

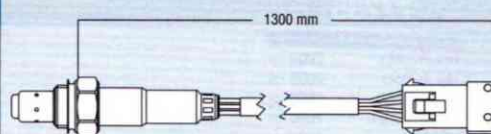

**Reemplaza/Suitable:** Bosch 0258 006 186  
 PSA 1628.PL, 1628.PX, 1628.QY

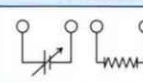
**4**
**Zr**

**77242**
**Adatt. Universal 77009**

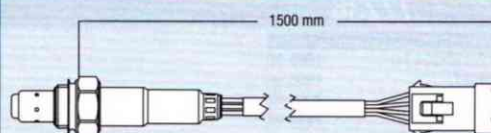
CITROEN		PEUGEOT	
Evasion 2.0i 16V	1998-00	206 1.4i (Depol IFL4)	1998 ->
Xantia 1.8i 16V, Break	1998 ->	307 2.0i 16V	2000 ->
XSara 2.0i 16V	2000 ->	307 SW 2.0i 16V	2002 ->
XSara Break 2.0i 16V	2000 ->	406 1.8i 16V, Break	1996-00
XSara Coupe 2.0i 16V	2000 ->	406 2.0i 16V, Break	1999 ->
XSara Picasso 1.8i 16V	2000 ->	406 Coupe 2.0i 16V	1999 ->
		607 2.0i 16V	2000 ->
		607 2.2i 16V	2000 ->
		806 2.0i 16V	1998-00

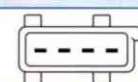
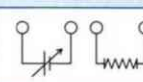

**Reemplaza/Suitable:** Bosch 0258 006 029  
 PSA 1628.CX, 1628.HV

**4**
**Zr**

**77280**
**Adatt. Universal 77004**

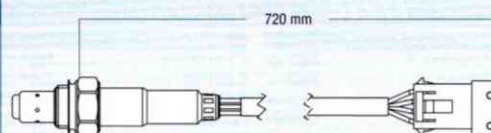
CITROEN		PEUGEOT	
Saxo 1.6 VTS (NFX)	1996-00	106 II 1.6 16V	1996-00

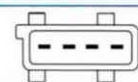
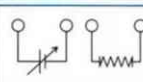

**Reemplaza/Suitable:** Bosch 0258 003 817, 0258 003 564  
 NTK OZA334-PG1

**4**
**Zr**

**77281**
**Adatt. Universal 77004**

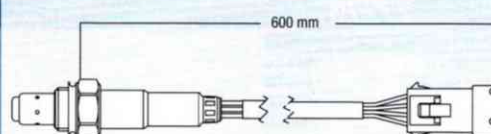
CITROEN		PEUGEOT	
Berlingo 1.4 i	1996 ->	106 II 1.4 i	2000 ->
C2 1.4	2003 ->	206 1.4 i	1998 ->
C3 1.4 i Bivalent	2002-05	206 SW 1.4	2002 ->
C3 Pluriel 1.4	2003 ->	306 1.4 SL, Break	2000 ->
C4 1.6 16V, Coupe	2005 ->	307 1.4	2000 ->
C5 1.8 16V, Break	2001-04	406 1.8 16V, Break	2000-04
Saxo 1.1 X, SX	1996 ->	1007 1.4	2005 ->
Saxo 1.4 VTS	1999 ->	Partner 1.4	2000 ->
XSara 1.4 i, Break, Coupe	2000 ->	Partner 1.4 Bifuel	2003 ->
XSara 1.6 16V, Break, Coupe	2000 ->		
XSara Picasso 1.8 16V	2000 ->		

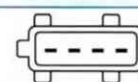
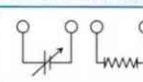

**Reemplaza/Suitable:** Bosch 0258 005 283  
 PSA 1628.KN, 1628.YK

**4**
**Zr**

**77282**
**Adatt. Universal 77009**

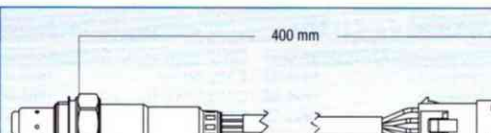
CITROEN		PEUGEOT	
Berlingo 1.4i	1996-02	106 II 1.0i, 1.1i	1996-02
C5 3.0 V6	2001 ->	106 II 1.4i, 1.6i	1996-02
C8 2.0, 2.2	2002 ->	206 1.4i, 1.6i	1998-00
Evasion 2.0 16V	2000-02	306 1.4 SL, 1.6 SR	1994-00
Jumpy 2.0 16V	2000-02	306 Cabrio 1.6	1996-00
Saxo 1.4 VTS	1996-00	406 1.8 16V	1995-00
Saxo 1.6 VTL, VTR	1996-00	406 3.0 V6, Coupe	2000 ->
Xantia 1.8i 16V	1998-02	607 3.0 V6 24V	2000 ->
XSara 1.4i, 1.6i	1997-02	Expert 2.0	1996-00
XSara Coupe 1.4i, 1.6i	1997-02	Partner 1.4i	1996-00
XSara Picasso 1.6i	2000 ->	Ranch 1.4i	1996-00

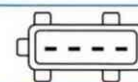
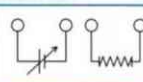

**Reemplaza/Suitable:** Bosch 0258 006 028  
 PSA 1628.CW

**4**
**Zr**

### IMPORTANTE:

Al pedir accesorios eléctricos, rogamos completen la referencia comenzando por 'F' (ejemplo: 381394 → F381394)

*Pour commander accessoires électriques, nous vous prions de compléter la référence en commençant par 'F'.*

When ordering electric accessories, please complete the reference by beginning with 'F'.



## ACCESORIOS ELÉCTRICOS

## ACCESSOIRES ELECTRIQUES / ELECTRIC ACCESSORIES



### SONDAS LAMBDA ESPECIFICAS SPECIFIC OXYGEN SENSORS SONDES LAMBDA SPECIFIQUES

#### 77283

Adatt. Universal 77009

CITROEN		PEUGEOT	
Berlingo 1.1i	1996-02	206, 206 CC, 206 SW	1998 ->
Berlingo 1.6i 16V	2000-02	306 1.6i, Break, Cabrio, SW	2000 ->
C3 1.1i	2002 ->	306 1.8 16V, Break, Cabrio	1997-02
C3 1.6i 16V	2002 ->	307 1.6i, SW	2000 ->
C5 2.0 16V, Break	2001 ->	406 2.0i 16V, Break, Coupe	1999-04
C5 3.0 V6, Break	2001 ->	406 3.0 V6, Break, Coupe	2000 ->
Jumper 2.0i	2002 ->	607 3.0 V6 24V	2000 ->
Saxo 1.1i X, SX	1996-02	Partner 1.1i, 1.6i 16V	1996-02
Saxo 1.4, 1.6, VTS	1996-02		
XSara 1.6i 16V, 2.0i 16V	2000 ->		
XSara Coupe 16V	2000 ->		
XSara Picasso 16V	2001 ->		

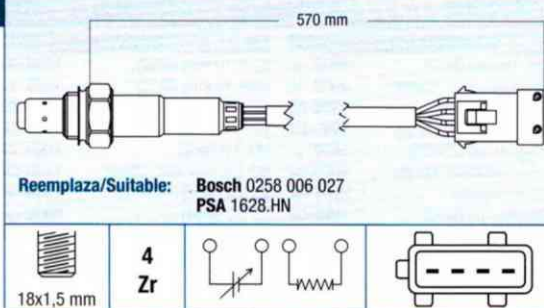

#### 77284

Adatt. Universal 77009

CITROEN		PEUGEOT	
Berlingo 1.4i	1996-00	306 1.4 SL, Break	1994-00
Evasion 2.0i 16V	1998-00	306 1.6 SR, Break, Cabrio	1994-00
XSara 1.4i	1997-00	307 2.0, SW	2000 ->
XSara 2.0i 16V	1997-00	406 2.0i 16V, Coupe	1999-00
XSara Break 1.4i	1997-00	406 2.2, SW	2000 ->
XSara Coupe 1.4i	1998-00	607 2.0i 16V	2000 ->
XSara Coupe 2.0i 16V	1998-00	607 2.2i 16V	2000 ->
		806 2.0i 16V	1998-00
		Partner 1.4i	1996-00
		Ranch 1.4i	1996-00

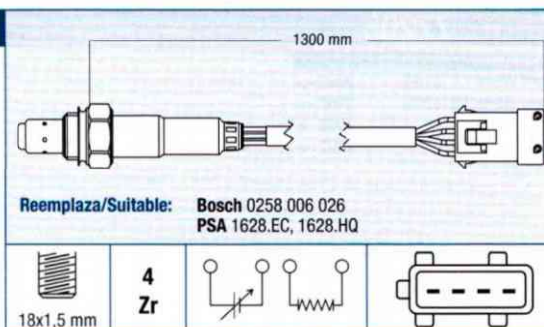

#### NEW 77387

Adatt. Universal 77008

PEUGEOT	
205 1.0	1987-98
205 1.1	1989-98
205 1.4	1988-98
205 1.6 Aut.	1990-98
205 1.9 GTI	1987-98
309 1.1	1990-93
309 1.4	1989-93
309 1.6	1989-93
309 1.9 GTI	1989-93
309 1.9 GTI 16V	1990-93
405 1.9, 1.9 4x4	1988-92
405 1.9 Sport MI-16	1988-92

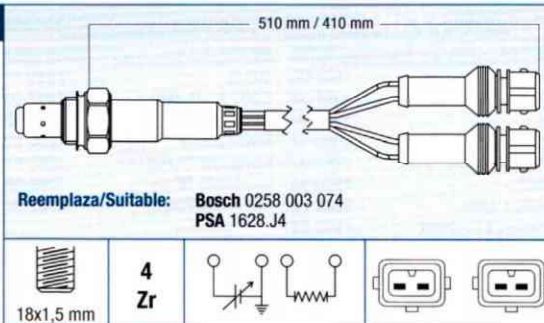

### IMPORTANTE:

Al pedir accesorios eléctricos, rogamos completen la referencia comenzando por 'F' (ejemplo: 381394 → F381394)  
 Pour commander accessoires électriques, nous vous prions de compléter la référence en commençant par 'F'.  
 When ordering electric accessories, please complete the reference by beginning with 'F'.



**CAPTADORES DE IMPULSOS**  
**REVOLUTION AND TIMING SENSORS**  
**CAPTEURS DU REGIME ET DES POSITIONS**



## ACCESORIOS ELÉCTRICOS

## ACCESSOIRES ELECTRIQUES / ELECTRIC ACCESSORIES



EJEMPLOS. GUIA DE CONSULTA  
EXAMPLES. CONSULTATION GUIDE  
EXEMPLES. GUIDE À LA CONSULTATION

FABRICANTE		COLOR / COLOUR / COULEUR		CONSTRUCTEUR	
Modelos	Años	Model	Year	Modèle	Année



Reemplaza/Suitable/Remplace:  
Cruce de Referencias.  
Cross References  
Tableau des equivalences

LONGITUD LENGHT LONGEUR	LONGITUD LENGHT LONGEUR	RESISTENCIA RESISTANCE RESISTANCE	CONEXIÓN CONNECTION CONNEXION
-------------------------------	-------------------------------	---	-------------------------------------

### SIMBOLOS - SYMBOLS - SYMBOLES



Aplicaciones por vehículos  
Vehicle application  
Applications pour véhicules



Motor  
Engine  
Moteur



Año  
Year  
Année



Información  
Information  
Information



Cruce de Referencias  
Cross References  
Tableau des equivalences



Tipo de conexión  
Type of connection  
Type de connexion



Longitud del cable en mm.  
Lenght of cable in mm.  
Longeur du cable en mm.



Longitud del sensor en mm.  
Lenght of sensor in mm.  
Longeur du capteur en mm.



Resistencia entre los terminales  
Resistance between the terminals  
Resistance entre les connexions



Sensores de revoluciones y de posición del cigüeñal y árbol de levas  
Revolution and timing sensors. (CKP & CMP)  
Capteurs du regime et des positions du vilebrequin et de l'arbre à cammes.



Resistencia Efecto Hall  
Hall effect Resistance  
Resistance effecte Hall

### LONGITUDES / LENGHT / LONGEURS

Longitud en mm. del cable y del sensor medido de la forma ilustrada:

Length in mm. of cable & of sensor measured as shown:

Longeur en mm. du cable et du capteur mesuré comme suit:

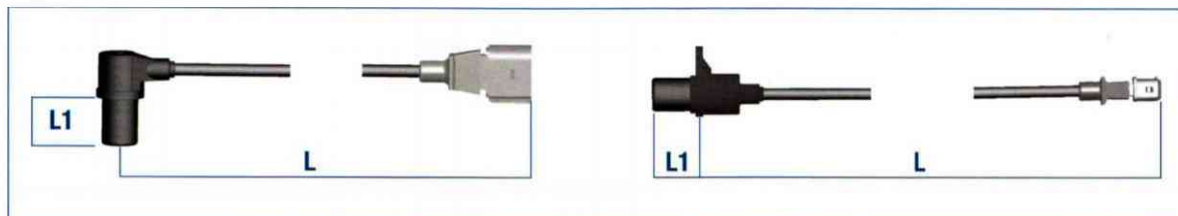

Para identificar una Captador de Impulsos de un modelo específico, consultar Aplicaciones por Vehículos. Las piezas contenidas en este Catálogo, pueden estar sujetas a modificaciones dimensionales o de material, sin previo aviso. Todas las unidades de medida expresadas en este Catálogo son en milímetros. Los pares de apriete están en Newton por metro. La Resistencia entre los terminales está en ohm.

Refer to Vehicle Applications to trace the Revolution and timing sensors of a specific model. The parts shown in this Catalogue, are subject to modification in design or material without notice.

All measurement units started on this Catalogue are in milimeters. Torques are in Newton by meter. Resistance between terminals are in ohm.

Pour trouver un modele spécifique d'un capteur du regime et des positions, consulter les Applications par Vehicules. Les pièces contenues dans ce Catalogue, peuvent être modifiées en matériel ou exécution sans préavis. Toutes les unités de mesure indiquées sur ce Catalogue sont en milimètres. La couple de serrage sont en Newton par metre. La resistance entre les connexions sont en ohm.

### IMPORTANTE:

Al pedir accesorios eléctricos, rogamos completen la referencia comenzando por 'F' (ejemplo: 381394 → F381394)

Pour commander accessoires electriques, nous vous prions de compléter la référence en commençant par 'F'.

When ordering electric accessories, please complete the reference by beginning with 'F'.

## ACCESORIOS ELÉCTRICOS

### ACCESSOIRES ELECTRIQUES / ELECTRIC ACCESSORIES



MATERIAL ELECTRICO / MATERIEL ELECTRIQUE / ELECTRIC PARTS



#### CAPTADORES DE IMPULSOS REVOLUTION AND TIMING SENSORS CAPTEURS DU REGIME ET DES POSITIONS

### NEW 79001

CITROEN		PEUGEOT	
Jumper 2.8 HDI, 4x4	2000-02	Boxer 2.8 HDI	2000-02

 Reemplaza / Suitable:  
PSA 1920.FA

L	L1	ohm	
450	30	700	

### 79007

CITROEN	
Jumper 2.8 HDI	2000 ->
Jumper 2.8 HDI 4x4	2000 ->

 Reemplaza / Suitable:  
Citroen 1920.EW

L	L1	ohm	
510	34,5	1100	

### 79033

CITROEN		FIAT		PEUGEOT	
AX 14	1987-97	Ducato 1.9 TD	1998-02	205 1.6i (XU5M)	1991-94
Berlingo 1.8i	1997 ->	Ducato 2.0i	1994-02	206 1.9 D	1999 ->
BX 19. BX GTI	1986-94	Scudo 1.9 TD, TD Eco	1996-02	306. Break, Cabriolet	1997 ->
Evasion	1997-02	Ulysse 1.8i, 2.0i	1997-02	405. 405 Break	1990-96
Jumper 2.0	1994-02	Ulysse 2.0i 16V, Turbo	1998-00	406. 406 Break, Coupe	1996 ->
Jumpy 1.9 TD	1996-02	Ulysse 2.1 TD	1996-99	605	1990-99
Xantia. Xantia Break	1994-00			806	1995-02
XM. XM Break	1994-00			Boxer 2.0i	1994-02
XSara. XSara Break	1997-02			Expert 1.9 TD	1996 ->
XSara Coupe	1998-00				
ZX. ZX Break	1992-98				

 Reemplaza / Suitable:  
Citroen 91.541.075  
96.037.097  
96.068.168

 Peugeot 1920.C3  
1920.W9  
5918.81  
5918.87  
5918.90

L	L1	ohm	
340	24	370	

### 79034

CITROEN		CITROEN Cont.		PEUGEOT Cont.	
AX 1.1	1986-91	XSara 1.6i, Break	1997-00	306 1.1	1994-00
AX 1.4	1991-93	XSara Coupe 1.4i, 1.6i	1998-00	306 1.4 SL, Break	1994-00
AX 1.4 GTI	1991-96	ZX 1.1, 1.1i	1991-98	306 1.6 SR, Break	1994-00
AX 10. AX 11. AX 14	1986-97	ZX 1.4i, Break	1991-97	306 Cabriolet 1.6i	1996-00
Berlingo 1.1i	1996 ->			405 1.4	1993-96
Berlingo 1.4i	1996 ->	106 I Gasolina/Petrol	1991-96	Partner 1.1, 1.4	1996 ->
Saxo 1.0 X	1996 ->	106 II 1.0i	1996 ->	Ranch 1.1i, 1.4i	1996 ->
Saxo 1.1 S, SX	1996 ->	106 II 1.1i	1997 ->		
Saxo 1.4 VTS	1996 ->	106 II 1.4i	1996 ->		
Saxo 1.6 VTL, VTR	1996 ->	106 II 1.6i	1996 ->		
Saxo 1.6 VTS	1996 ->	106 II 1.6i 16V	1996 ->		
XSara 1.4i, Break	1997 ->	205 1.0i, 1.4i	1991-94		

 Reemplaza / Suitable:  
Citroen 96.085.170  
Peugeot 1920.4A  
1920.J5  
1920.Z3

L	L1	ohm	
340	24	370	

### 79051

CITROEN		PEUGEOT	
BX 1.9i GTI	1987-93	405 1.9i	1993-96
ZX 1.9i	1991-96		

 Reemplaza / Suitable:  
Bosch 0261 210 065  
PSA 0261 210 154  
5910.80

L	L1	ohm	
330	24	900	

#### IMPORTANTE:

Al pedir accesorios eléctricos, rogamos completen la referencia comenzando por 'F' (ejemplo: 381394 → F381394)

*Pour commander accessoires électriques, nous vous prions de compléter la référence en commençant par 'F'.*

When ordering electric accessories, please complete the reference by beginning with 'F'.



## ACCESORIOS ELÉCTRICOS

## ACCESSOIRES ELECTRIQUES / ELECTRIC ACCESSORIES

**CAPTADORES DE IMPULSOS**  
**REVOLUTION AND TIMING SENSORS**  
**CAPTEURS DU REGIME ET DES POSITIONS**
**79054**

CITROEN		PEUGEOT	
Jumpy 1.6i	1995 ->	Expert 1.6i	1996 ->

**Reemplaza / Suitable:**  
 Bosch 0261 210 127  
 PSA 1920.Y9
L  
430L1  
24ohm  
900**79100**

CITROEN		PEUGEOT	
Saxo 1.4i VTS	1996 ->	106 1.4i	1996 ->
Saxo 1.6i VTL, VTR	1996 ->	106 1.6i	1996 ->
Saxo 1.6 VTS	2000 ->	206 1.4 i	1998 ->
XSara 1.6i, Break	1997-00	306 1.6 SR	1994-00
XSara Coupe 1.6i	1998-00	306 1.6i, Break	1994-00
		306 Cabrio 1.6i	1996-00

**Reemplaza / Suitable:**  
 PSA 1920.5v
L  
---L1  
33ohm  
550**79101**

CITROEN		PEUGEOT	
AX 10	1986-98	106 II 1.0i	1996 ->
AX 14	1987-97	106 II 1.1i	1996 ->
Saxo 1.6 VTS	1996 ->	106 II 1.4i	1996 ->
		106 II 1.6i	1996 ->
		106 II 1.6i S16	1996 ->
		206 1.1i, SW	1998 ->
		206 1.4i, SW	1998 ->
		206 1.6i, SW	1998-00
		306 1.4 SL, Break	1994 ->
		306 1.6 SR, Break	1994-00
		306 Cabrio 1.6	1996-00
		Partner 1.1, 1.4	1996 ->

**Reemplaza / Suitable:**  
 PSA 1920.5T
L  
---L1  
38,5ohm  
550**79102**

Aislante azul / Blue colour

CITROEN		PEUGEOT	
Berlingo 1.4i	1996 ->	306 1.4i	1997 ->
Berlingo 1.4i Multispace	1997 ->	306 2.0i 16V	1993 ->
Saxo 1.4i	1996 ->	405 2.0i 16V	1993-96
Xantia 2.0i 16V	1993-97	405 2.0i Turbo	1993-96
XSara 1.4i	1997 ->	Partner 1.4i	1996 ->
XSara 2.0i 16V	1998 ->	Ranch 1.4i	1996 ->
ZX 2.0i 16V	1992-96		

**Reemplaza / Suitable:**  
 Electricfil 14.43.08  
 PSA 1920.L1
L  
---L1  
28Hall  
Effect**79104**

CITROEN		PEUGEOT	
Evasion 2.0i 16V	1998-00	306 1.8i 16V	1997 ->
Xantia 1.8i 16V	1998 ->	306 Break 1.8i 16V	1997 ->
Xantia Break 1.8i 16V	1998 ->	306 Cabrio 1.8i 16V	2000 ->
		406 1.8i 16V	1996-00
		406 Break 1.8i 16V	1996-00
		806 2.0i 16V	1998-00

**Reemplaza / Suitable:**  
 Electricfil 14.43.21  
 Fiat 9629684380  
 PSA 1920.6T
L  
---L1  
29Hall  
Effect**IMPORTANTE:**
**Al pedir accesorios eléctricos, rogamos completen la referencia comenzando por 'F' (ejemplo: 381394 → F381394)**
*Pour commander accessoires électriques, nous vous prions de compléter la référence en commençant par 'F'.*

When ordering electric accessories, please complete the reference by beginning with 'F'.

**ACCESORIOS ELÉCTRICOS**
**ACCESSOIRES ELECTRIQUES / ELECTRIC ACCESSORIES**

**CAPTADORES DE IMPULSOS  
REVOLUTION AND TIMING SENSORS  
CAPTEURS DU REGIME ET DES POSITIONS**
**79114**

CITROEN		PEUGEOT	
C8 2.0	2002 ->	806 2.0 HDI	1999-02
C8 2.0 HDI	2002 ->	Expert 2.0i 16V	2000 ->
C8 2.2	2002 ->	Expert 2.0 HDI	1999 ->
C8 2.2 HDI	2002 ->	Expert 2.0 HDI 16V	2000 ->
Evasion 2.0i 16V	2000-02		
Evasion 2.0 HDI	2001 ->		
Jumpy 1.9	2000 ->		
Jumpy 2.0 HDI	2000 ->		
Jumpy 2.0i 16V	2000 ->		



Reemplaza / Suitable:  
Citroen 96.357.329  
Fiat 9635732980  
Peugeot 1920.9C

L	L1	ohm	
---	24	400	

**79116**

CITROEN		CITROEN Cont.		PEUGEOT	
Berlingo 2.0 HDI 90	2000 ->	XSara Coupe 2.0 16V	2000 ->	206 2.0 HDI 90	2000 ->
C5 1.8 16V	2001 ->	XSara Coupe 2.0 HDI 90	1999 ->	206 2.0i S16	1999 ->
C5 2.0 16V	2001 ->	XSara Picasso	2000 ->	206 CC 2.0i 16V	2000 ->
C5 2.0 16V HPI	2001 ->			206 SW 2.0i 16V	2002 ->
C5 2.0 HDI	2001 ->			307 2.0i, Break, SW	2000 ->
C5 2.2 HDI	2001 ->			307 2.0 HDI 90, Break, SW	2002 ->
Evasion 2.0i 16V	2000-02			406 1.8 16V, Break	2000-04
Jumper 2.0i	1999-02			406 2.0 16V, HPI, Break	1999-04
Jumper 2.2 HDI	2002 ->			406 2.0 HDI 110, Break	1998-01
Jumpy 2.0i 16V	2000 ->			406 Coupe 2.0 16V	1999-02
XSara 2.0i 16V	2000 ->			607 2.2 16V	2000 ->
XSara HDI 90	1999 ->			607 2.2 HDI	2000 ->



Reemplaza / Suitable:  
Citroen 96.324.005  
Peugeot 1920.7N

L	L1	ohm	
---	24	400	

**79117**

CITROEN		PEUGEOT	
XSara 2.0i 16V	2000 ->	307 2.0 HDI 110	2000 ->
XSara Break 2.0i 16V	2000 ->	307 SW 2.0 HDI	2002 ->
XSara Coupe 2.0i 16V	2000 ->		
XSara Picasso 2.0i 16V	2001 ->		
XSara Picasso 2.0 HDI	2000 ->		



Reemplaza / Suitable:  
Citroen 96.406.277  
Peugeot 1920.EN  
1920.FP

L	L1	ohm	
---	24	470	

**79118**

CITROEN		PEUGEOT	
Berlingo 1.1i	1996 ->	106 II 1.1i	1996 ->
Berlingo 1.4i	1996 ->	106 II 1.4i	1996 ->
C3 1.1i	2002 ->	106 II 1.6i 16V	1996 ->
C3 1.4i	2002 ->	206 1.1i, SW	1998 ->
C3 1.6i 16V	2002 ->	206 1.4i, SW	1998 ->
Saxo 1.0 X	1996 ->	206 1.6i 16V, SW	2000 ->
Saxo 1.1 X, SX	1996 ->	206 CC 1.6 16V	2000 ->
Saxo 1.4 VTS	1996 ->	306 1.4 SL, Break	1994 ->
Saxo 1.6 VTL, VTR, VTS	1996 ->	306 1.6i, Break	1997 ->
XSara 1.4i, Break, Coupe	1997 ->	306 Cabrio 1.6i	2000 ->
XSara 1.6i, Break, Coup	1997-00	307 1.4i, Break	2000 ->
XSara 1.6i 16V, Coupe	2000 ->	307 1.6i, Brak, SW	2000 ->



Reemplaza / Suitable:  
Citroen 96.399.998  
Peugeot 1920.AW

L	L1	ohm	
---	38	500	

**79119**

CITROEN		PEUGEOT	
XSara 1.6i 16V	2000 ->	206 1.4i	1998 ->
XSara Break 1.6 16V	2000 ->	206 1.6i 16V	2000 ->
XSara Coupe 1.6 16V	2000 ->	206 CC 1.6 16V	2000 ->
		306 1.6i	2000 ->
		306 Break 1.6i	2000 ->
		306 Cabrio 1.6i	2000 ->
		307 1.6	2000 ->
		307 Break 1.6	2002 ->
		307 SW 1.6	2002 ->



Reemplaza / Suitable:  
Citroen 96.399.998  
Peugeot 1920.AV

L	L1	ohm	
---	32,5	500	

**IMPORTANTE:**

Al pedir accesorios eléctricos, rogamos completen la referencia comenzando por 'F' (ejemplo: 381394 → F381394)

*Pour commander accessoires electriques, nous vous prions de compléter la référence en commençant par 'F'.*

When ordering electric accessories, please complete the reference by beginning with 'F'.



## ACCESORIOS ELÉCTRICOS

## ACCESSOIRES ELECTRIQUES / ELECTRIC ACCESSORIES

**CAPTADORES DE IMPULSOS**  
**REVOLUTION AND TIMING SENSORS**  
**CAPTEURS DU REGIME ET DES POSITIONS**
**79120**

CITROEN		PEUGEOT	
Berlingo 1.9 D	1998 ->	306 1.9 D, Break	1998 ->
Berlingo 2.0 HDI 90	2000 ->	306 2.0 HDI 90, Break	1999 ->
C5 2.0 HDI	2001 ->	406 2.0 HDI 90, Break	1999-04
C5 2.2 HDI, Break	2001 ->	406 2.0 HDI 110	1998-01
C5 3.0 V6, Break	2001 ->	406 2.2 HDI, Coupe	2000-04
XSara 2.0 HDI 90	1999 ->	406 3.0 V6, Break	2000-04
XSara 2.0 HDI 109	2001 ->	406 Coupe 3.0 V6	2000-04
XSara Break 2.0 HDI 90	1999 ->	607 2.0 HDI	2000 ->
XSara 2.0 HDI 109	2001 ->	607 2.2 HDI	2000 ->
XSara Coupe 2.0 HDI 90	1999 ->	607 3.0 V6 24V	2000 ->
XSara Coupe 2.0 HDI 109	2001 ->	Partner 1.9 D	1999 ->
		Partner 2.0 HDI	2000 ->



**Reemplaza / Suitable:**  
 Citroen 96.328.897  
 Peugeot 1920.8S

L	L1	ohm	
---	24	400	

**79135**

CITROEN		PEUGEOT	
Berlingo 1.6i 16V	2000 ->	406 2.2	2000-04
XSara 2.0 HDI 90	1999 ->	406 Break 2.2	2000-04
XSara Break 2.0 HDI 90	1999 ->	607 2.0i 16V	2000 ->
XSara Coupe 2.0 HDI 90	1999 ->	607 2.2i 16V	2000 ->
XSara Picasso 1.6i	2000 ->	Partner 1.6i 16V	2001 ->



**Reemplaza / Suitable:**  
 Citroen 96.334.757  
 Peugeot 1920.7P

L	L1	ohm	
---	24	400	

**79147**

CITROEN		PEUGEOT	
C3 1.4 HDI	2002 ->	206 1.4 HDI	2002 ->
C3 1.4 HDI 16V	2002 ->	307 1.4 HDI	2002 ->



**Reemplaza / Suitable:**  
 Citroen 96.374.991  
 PSA 1920.EJ

L	L1	Hall Effect	
---	---		

 Motores/Engines/Moteurs:  
 DV4TD, DV4TED4
**79148**

CITROEN		PEUGEOT	
C3 1.4 HDI	2002 ->	107 1.4 HDI	2004 ->
C3 1.4 HDI 16V	2002 ->	107 1.4 HDI 16V	2004 ->
C3 HDI (DV6TED5)	2004 ->	107 HDI (DV6TED4)	2004 ->
XSara 1.4 HDI	2002 ->	206 1.4 HDI	2002 ->
XSara 1.4 HDI 16V	2002 ->	307 1.4 HDI	2002 ->
XSara HDI (DV6TED4)	2004 ->	307 1.4 HDI 16V	2002 ->
		307 HDI (DV6TED4)	2004 ->



**Reemplaza / Suitable:**  
 Citroen 96.372.208  
 PSA 1920.EH

L	L1	Hall Effect	
---	---		

 Motores/Engines/Moteurs:  
 DV4TD, DV4TED4.
**79149**

CITROEN		PEUGEOT	
C5 2.2 16V HPI	2002 ->	406 2.2 16V HPI	2002 ->
C5 3.0 V6 24V	2002 ->	406 3.0 V6 24V	2002 ->
		607 3.0 V6 24V	2002 ->

**Reemplaza / Suitable:**  
 Citroen 96.346.055  
 PSA 1920.AE

L	L1	Hall Effect	
---	19,5		

 Motores/Engines/Moteurs:  
 ES9T4S.

 Motores/Engines/Moteurs:  
 L7X.
**IMPORTANTE:**
**Al pedir accesorios eléctricos, rogamos completen la referencia comenzando por 'F' (ejemplo: 381394 → F381394)**
*Pour commander accessoires électriques, nous vous prions de compléter la référence en commençant par 'F'.*

When ordering electric accessories, please complete the reference by beginning with 'F'.

**ACCESORIOS ELÉCTRICOS**
**ACCESSOIRES ELECTRIQUES / ELECTRIC ACCESSORIES**

**CAPTADORES DE IMPULSOS  
REVOLUTION AND TIMING SENSORS  
CAPTEURS DU REGIME ET DES POSITIONS**
**79150**

CITROEN		PEUGEOT	
C5 2.0 16V (EW6J4)	2002 ->	206 2.0i	2002 ->
C5 2.0 16V (EW7J4)	2002 ->	307 2.0i	2002 ->
Xsara 2.0 i (EW10J4)	2002 ->	406 2.0i	2002 ->
XSara Picasso 2.0i (EW10J4)	2002 ->	406 2.0 16V (EW6J4)	2002 ->
		406 2.0 16V (EW7J4)	2002 ->
		607 2.0i	2002 ->
		806 2.0i	2002 ->

 Motores/Engines/Moteurs:  
EW10J4.

**Reemplaza / Suitable:**  
 Citroen 96.291.398  
 PSA 1920.8W

L ---	L1 30	Hall Effect	
----------	----------	----------------	--

**79151**

CITROEN		PEUGEOT	
Berlingo 2.0 HDI	2000 ->	806 2.0 HDI 110	2002 ->
C5 2.0 HDI	2000 ->	807 2.0 HDI 110	2002 ->
C5 2.2 HDI	2002 ->	Expert 2.0 HDI 110	2002 ->
C8 2.0 HDI 110	2000 ->		
C8 2.2 HDI	2002 ->		
Evasion 2.0 HDI 110	2000 ->		
Jumper 2.0 HDI 90	2000 ->		
Jumper II 2.2 HDI	2002 ->		
Jumpy 2.0 HDI 110	2000 ->		
Xantia II 2.0 HDI 90	2002 ->		
XSara 2.0 HDI	2000 ->		
XSara Picasso 2.0 HDI	2002 ->		

**Reemplaza / Suitable:**  
 Citroen 96.285.598  
 PSA 1920.7V

L ---	L1 29	Hall Effect	
----------	----------	----------------	--

**79152**

CITROEN		PEUGEOT	
AX 1.5 Diesel	1994-97	106 1.5 Diesel	1993-96
XM 2.1 Turbo D	1994-97	605 2.1 Turbo D	1991-95

**Reemplaza / Suitable:**  
 Citroen 96.140.044  
 96.168.062  
 Peugeot 5918.91  
 5918.93

L 375	L1 39	ohm 110	
----------	----------	------------	--

**79153**

CITROEN		PEUGEOT	
ZX 1.9 Diesel	1994-97	306 1.9 Diesel	1993-96
Xantia 1.9 D	1995-98	306 1.9 Turbo D	1993-97
Xantia 1.9 Turbo D	1995-98	405 1.9 D	1994-98
		405 1.9 Turbo D	1994-98

**Reemplaza / Suitable:**  
 Citroen 96.067.317  
 Peugeot 5918.94

L 615	L1 39	ohm 110	
----------	----------	------------	--

**79154**

CITROEN		PEUGEOT	
BX 16 E	1989-93	405 1.6	1987-92
BX Break 16	1989-94	405 1.6i	1989-92
XM 3.0 V6	1990-94	405 Break 1.6i	1989-92
XM 3.0 V6 24V	1994-00	605 3.0 SV 24	1989-99

**Reemplaza / Suitable:**  
 Citroen 96.067.317  
 Peugeot 1920.E2  
 1920.F5

L 230	L1 24	ohm 370	
----------	----------	------------	--

**IMPORTANTE:**
**Al pedir accesorios eléctricos, rogamos completen la referencia comenzando por 'F' (ejemplo: 381394 → F381394)**
*Pour commander accessoires électriques, nous vous prions de compléter la référence en commençant par 'F'.*

When ordering electric accessories, please complete the reference by beginning with 'F'.



## ACCESORIOS ELÉCTRICOS

## ACCESSOIRES ELECTRIQUES / ELECTRIC ACCESSORIES



### CAPTADORES DE IMPULSOS REVOLUTION AND TIMING SENSORS CAPTEURS DU REGIME ET DES POSITIONS

#### 79156

CITROEN		PEUGEOT	
AX	1987-96	104	1985-88
BX	1985-94	106	1991-93
		205	1985-93
		305	1985-89
		309	1986-93
		405	1986-93
		505	1985-92
		605	1989-93



Reemplaza / Suitable:  
Peugeot 5918.75

L  
820

L1  
39

ohm  
710

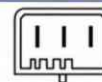

#### 79158

CITROEN		PEUGEOT	
Xantia 1.9 D	1993-97	306 1.7 Diesel	1994-97
Xantia 1.9 Turbo D		405 1.7 Turbo D	
ZX 1.7 Diesel		405 1.9 Diesel	
ZX 1.9 Diesel		806 1.9 Turbo D	
ZX 1.9 Turbo D			



Reemplaza / Suitable:  
Citroen 96.140.044  
Peugeot 5918.92

L  
600

L1  
39

ohm  
70

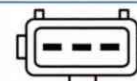

Motores/Engines/Moteurs:  
XUD7, XUD9A, XUD9T.

### IMPORTANTE:

Al pedir accesorios eléctricos, rogamos completen la referencia comenzando por 'F' (ejemplo: 381394 → F381394)  
 Pour commander accessoires électriques, nous vous prions de compléter la référence en commençant par 'F'.  
 When ordering electric accessories, please complete the reference by beginning with 'F'.

**BOBINAS DE ENCENDIDO Y CABLES DE BUJIA**  
**IGNITION COILS AND IGNITION LEADS**  
**BOBINES D'ALLUMAGE ET FAISCEAUX DE BOUGIES**

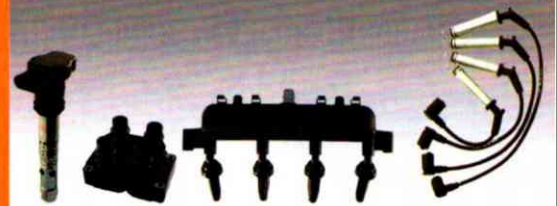

**BOBINAS DE ENCENDIDO**  
**IGNITION COILS**  
**BOBINES D'ALLUMAGE**



**CABLES BUJIAS ANTIPARASITARIOS**  
**SUPPRESSOR IGNITION LEADS**  
**FAISCEAUX DE BOUGIE ANTIPARASITAIRES**



## ACCESORIOS ELÉCTRICOS

## ACCESSOIRES ELECTRIQUES / ELECTRIC ACCESSORIES



**BOBINAS DE ENCENDIDO**  
**IGNITION COILS**  
**BOBINES D'ALLUMAGE**

REF. FAE		COLOR / COLOUR / COULEUR	
FABRICANTE	Años	MAKER	Year
Modelos		Modèle	Année



Reemplaza/Suitable/Remplace:  
Cruce de Referencias.  
Cross References  
Tableau des equivalences

A	B	C	D
---	---	---	---

- |   |   |   |   |
|---|---|---|---|
| <p><b>A</b> Resistencia del primario<br/>Primary resistance<br/>Resistance primaire</p> | <p><b>B</b> Conexión de alta tensión<br/>High voltage connection<br/>Connection haute tension</p> | <p><b>C</b> Resistencia del secundario<br/>Secondary resistance<br/>Resistance secondaire</p> | <p><b>D</b> Conexión de baja tensión<br/>Low tension connection<br/>Connection baisse tension</p> |
|---|---|---|---|

### SIMBOLOS / SYMBOLS / SYMBOLES



**BOBINAS DE ENCENDIDO**  
**IGNITION COILS**  
**BOBINES D'ALLUMAGE**



**INFORMACIÓN**  
**INFORMATION**  
**INFORMATION**



**RESISTENCIA DEL PRIMARIO**  
**PRIMARY RESISTANCE**  
**RESISTANCE PRIMAIRE**



**RESISTENCIA DEL SECUNDARIO**  
**SECONDARY RESISTANCE**  
**RESISTANCE SECONDAIRE**



**SÍMBOLO DEL DIODO**  
**SYMBOL OF DIODE**  
**SYMBOL DU DIODE**



**TIPO DE CONEXIÓN**  
**TYPE OF CONNECTION**  
**TYPE DE CONNEXION**



**CONECTOR DIN Ø 4 / Ø 6,35 / Ø 8,2 / Ø 9**  
**CONNECTOR DIN Ø 4 / Ø 6,35 / Ø 8,2 / Ø 9**  
**CONEXION DIN Ø 4 / Ø 6,35 / Ø 8,2 / Ø 9**



**CONECTOR Ø 4**  
**CONNECTOR Ø 4**  
**CONEXION Ø 4**



**CONECTOR SAE Ø 6**  
**CONNECTOR SAE Ø 6**  
**CONEXION SAE Ø 6**



**CONECTOR Ø 7**  
**CONNECTOR Ø 7**  
**CONEXION Ø 7**

### INFORMACIÓN TÉCNICA / TECHNICAL INFORMATION / INFORMATION TECHNIQUE

#### CONEXION CONNECTION CONNEXION

CONECTORES  
CONNECTORS  
CONNECTEURS

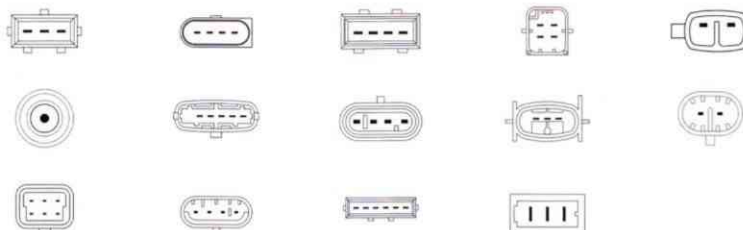

TERMINALES  
TERMINALS  
BORNES



#### IMPORTANTE:

**Al pedir accesorios eléctricos, rogamos completen la referencia comenzando por 'F' (ejemplo: 381394 → F381394)**  
*Pour commander accessoires électriques, nous vous prions de compléter la référence en commençant par 'F'.*  
When ordering electric accessories, please complete the reference by beginning with 'F'.

# ACCESORIOS ELÉCTRICOS

## ACCESSOIRES ELECTRIQUES / ELECTRIC ACCESSORIES



### BOBINAS DE ENCENDIDO IGNITION COILS BOBINES D'ALLUMAGE

#### 80205

Cil. 2, 3

RENAULT	
Clio 1.4	1998-01
Clio 1.6 e	1998-01
Kangoo 1.4	1998-01
Megane 1.6 e	1996-01
Megane 1.6 i	1996-01

 Reemplaza / Suitable:  
Renault 7700 100 643

1,4 Ω



9,5 KΩ

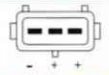

#### 80207

CITROEN		PEUGEOT	
Berlingo 1.1, 1.4, 1.8	1996 ->	106 II 1.1, 1.6	1996 ->
BX 1.6, 1.9	1986-93	306 1.6, 1.8, 2.0	1993 ->
Evasion 2.0, 2.0 T	1994-02	405 II 1.6, 1.8, 2.0	1992-95
Jumper 2.0	1994-02	406 1.6, 1.8, 2.0 T	1996-04
Saxo 1.0	1996 ->	605 2.0, 2.0 T	1989-99
Xantia 1.6, 1.8, 2.0	1996-98	806 1.8, 2.0, 2.0 T	1994-02
XM 2.0, 2.0 T	1989-94	Boxer 2.0	1994-02
XSara 1.4, 1.6, 1.8	1997-05	Partner 1.1, 1.4, 1.8	1996 ->
ZX 1.4, 1.6, 1.8, 2.0	1991-97		

 Reemplaza / Suitable:  
Citroën 96.228.897  
Fiat 9607405480  
9622889780  
PSA 5970.48  
5970.60  
5970.70

0,65 Ω



7,5 KΩ

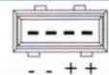

#### 80208

CITROEN		PEUGEOT	
Berlingo 1.4i	1996 ->	1007 1.4	2005 ->
C2 1.1, 1.4	2003 ->	106 II 1.4 i, 1.4i, 1.6i	1996 ->
C3 1.1i, 1.4i	2002 ->	206 1.1i, 1.4i, 1.6i	1998 ->
C3 1.4 Pluriel	2003 ->	206 SW 1.1, 1.4, 1.4 16V	2002 ->
Saxo 1.0 X, 1.1 X, SX	1996 ->	306 1.4 SL, Break	1994 ->
Saxo 1.4 VTS, 1.6 VTL, VTR	1996 ->	307 1.4, 1.6 16V, Break	2000 ->
XSara 1.4i, 1.6i, Break	1997-05	307 CC 1.6 16V	2005 ->
XSara Picasso 1.6	2000 ->	307 SW 1.4 16V, 1.6 16V	2002 ->
		406 1.6	1996-04
		Partner 1.1, 1.4	1996 ->

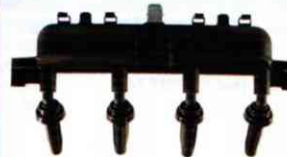
 Reemplaza / Suitable:  
Citroën 96.358.649  
96.358.848  
PSA 5970.72  
5970.79

0,55 Ω



3,5 KΩ

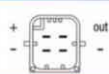

#### NEW 80226

CITROEN		PEUGEOT	
AX 10	1987-98	106 II 1.0 i	1997 ->
Berlingo 1.4 i	1996 ->	106 II 1.1 i	1997 ->
Saxo 1.0 X	1998 ->	106 II 1.4 i	1996 ->
Saxo 1.1 X, SX	1996 ->	206 1.1 i	1998 ->
Saxo 1.4 VTS	1996 ->	206 1.4 i	1998 ->
Saxo 1.6 VTL, VTR	1996 ->	306 1.4 SL, Break	1994-01
XSara 1.4 i, Break, coupe	1997-05	306 1.6, Break, Cabrio	1993-01
XSara 1.6 i, Break, coupe	1997-00	Partner 1.1, Combi	1996 ->
XSara Picasso 1.6	2000 ->	Partner 1.4, Combi	1996 ->

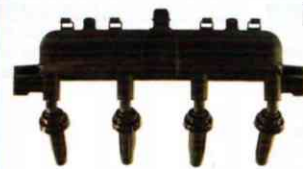
 Reemplaza / Suitable:  
Citroën 96.281.585  
PSA 5970.72  
5970.74

0,52 Ω



6 KΩ



#### NEW 80235

CITROEN		PEUGEOT	
Berlingo 1.6 16V	2000 ->	1007 1.6 16V	2005 ->
C2 1.6	2003 ->	206 1.6 16V	2001 ->
C2 1.6 VTS	2005 ->	206 CC 1.6 16V	2000 ->
C3 1.6 16V	2002 ->	206 SW 1.6 16V	2002 ->
C3 Pluriel 1.6	2003 ->	Partner 1.6 16V	2001 ->
C4 1.6 16V	2005 ->	Partner Combi 1.6 16V	2001 ->
C4 Coupe 1.6 16V	2005 ->		
XSara 1.6 16V	2000-05		
XSara Break 1.6 16V	2000-05		
XSara Coupe 1.6 16V	2000-05		

 Reemplaza / Suitable:  
PSA 5970.80

0,54 Ω



15,5 KΩ

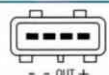

### IMPORTANTE:

Al pedir accesorios eléctricos, rogamos completen la referencia comenzando por 'F' (ejemplo: 381394 → F381394)

Pour commander accessoires électriques, nous vous prions de compléter la référence en commençant par 'F'.

When ordering electric accessories, please complete the reference by beginning with 'F'.



ACCESORIOS ELÉCTRICOS

ACCESSOIRES ELECTRIQUES / ELECTRIC ACCESSORIES



BOBINAS DE ENCENDIDO  
IGNITION COILS  
BOBINES D'ALLUMAGE

**NEW 80237**

CITROEN		PEUGEOT	
Evasion 1.8	1997-02	306 1.8 16V	1997-01
Evasion 2.0 16V	1998-00	306 2.0 16V	1997-01
Xantia 1.8i 16V	1995-98	306 Break 1.8 16V	1997-02
Xantia 2.0i 16V 132 cv.	1995-98	306 Break 2.0 16V	1997-02
Xantia 2.0i 16V 150 cv.	1994-98	306 Cabrio 2.0 16V	1997-02
Xantia Break 1.8i 16V	1995-98	406 1.8 16V, Break	1996-00
Xantia Break 2.0i 16V	1995-98	406 2.0 16V, Break	1996-04
XM 2.0i 16V	1994-00	406 Coupe 2.0 16V	1997-04
XM Break 2.0i 16V	1994-00	605 2.0 16V	1994-99
XSara 1.8i 16V	1997-00		
XSara Break 1.8i 16V	1997-00		
ZX Break 1.8i 16V	1996-98		

Reemplaza / Suitable:  
PSA 5970.51  
5970.73



0,55 Ω



15 KΩ

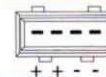

**IMPORTANTE:**

Al pedir accesorios eléctricos, rogamos completen la referencia comenzando por 'F' (ejemplo: 381394 → F381394)  
 Pour commander accessoires électriques, nous vous prions de compléter la référence en commençant par 'F'.  
 When ordering electric accessories, please complete the reference by beginning with 'F'.

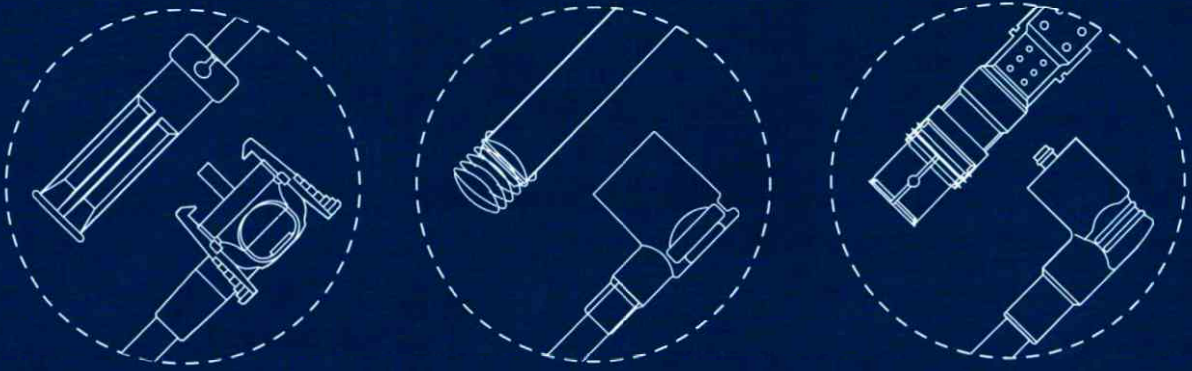

**CABLES DE BUJIA**  
**IGNITION LEADS**  
**FAISCEAUX DE BOUGIES**



## ACCESORIOS ELÉCTRICOS

## ACCESSOIRES ELECTRIQUES / ELECTRIC ACCESSORIES



EJEMPLOS. GUIA DE CONSULTA  
EXAMPLES. CONSULTATION GUIDE  
EXEMPLES. GUIDE À LA CONSULTATION

NEW REF. FAE	
FABRICANTE	
Modelos	Años
MAKER	
Model	Year
CONSTRUCTEUR	
Modèle	Année

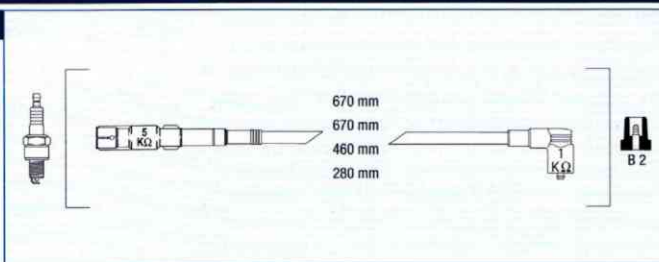

### SIMBOLOS - SYMBOLS - SYMBOLES



CONECTOR SAE Ø 6,3.  
CONNECTOR SAE Ø 6,3.  
CONEXION SAE Ø 6,3.



CONECTOR SAE Ø 6,3.  
CONNECTOR SAE Ø 6,3.  
CONEXION SAE Ø 6,3.



CONECTOR DIN Ø 5.  
CONNECTOR DIN Ø 5.  
CONEXION DIN Ø 5.



CONECTOR M4.  
CONNECTOR M4.  
CONEXION M4.



CONECTOR Ø 4.  
CONNECTOR Ø 4.  
CONEXION Ø 4.



CABLE RESISTIVO 920-1380 Ω/m.  
RESISTANCE OF CABLE 920-1380 Ω/m.  
CABLE À RESISTANCE 920-1380 Ω/m.



TAPA DE DISTRIBUIDOR.  
DISTRIBUIDOR CAP.  
TETE D'ALLUMEUR.



CONECTOR DIN Ø 8,2.  
CONNECTOR DIN Ø 8,2.  
CONEXION DIN Ø 8,2.



SUPRESOR ANTIPARASITARIO 5000 Ω.  
5000 Ω SUPPRESSOR.  
SUPRESSEUR ANTI-PARASITE 5000 Ω.



BOBINA DE ENCENDIDO.  
IGNITION COIL.  
BOBINE D'ALLUMAGE.



CONECTOR EN LA BOBINA FORD.  
CONNECTOR ON COIL FORD.  
CONEXION POUR BOBINE FORD.



SUPRESOR ANTIPARASITARIO 1000 Ω.  
1000 Ω SUPPRESSOR.  
SUPRESSEUR ANTI-PARASITE 1000 Ω.

### LONGITUDES / LENGTH / LONGUEURS

Longitud en mm. de cada cable medido de la forma ilustrada:  
Length in mm. of single ignition lead measured as shown:  
Longeur en mm. de chaque fil de bougie mesuré comme suit:

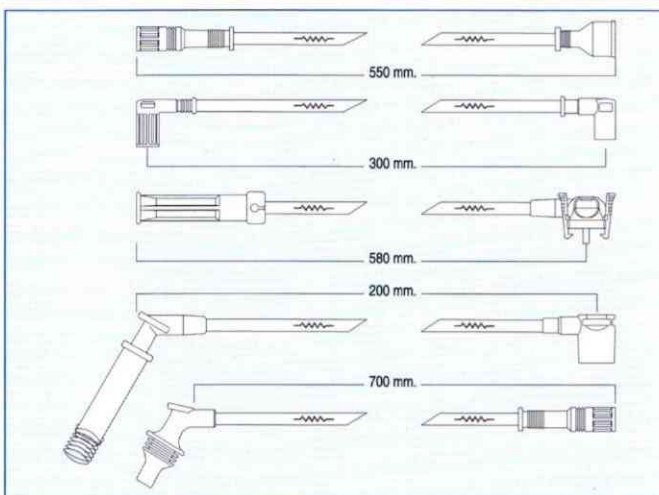

Las piezas contenidas en este Catálogo, pueden estar sujetas a modificaciones dimensionales o de material, sin previo aviso.  
The parts shown in this Catalogue, are subject to modification in design or material without notice.  
Les pièces contenues dans ce Catalogue, peuvent être modifiées en matériel ou exécution sans préavis.

Para identificar un juego de cables de encendido de un modelo específico, consultar Aplicaciones por Vehículos.  
Refer to Vehicle Applications to trace the ignition cable set of a specific model.  
Pour trouver un modèle spécifique d'un jeu de cables, consulter les Applications par Vehicules.



### IMPORTANTE:

Al pedir accesorios eléctricos, rogamos completen la referencia comenzando por 'F' (ejemplo: 381394 → F381394)  
Pour commander accessoires électriques, nous vous prions de compléter la référence en commençant par 'F'.  
When ordering electric accessories, please complete the reference by beginning with 'F'.

**ACCESORIOS ELÉCTRICOS**
**ACCESSOIRES ELECTRIQUES / ELECTRIC ACCESSORIES**

**CABLES BUJIAS ANTIPARASITARIOS  
SUPPRESSOR IGNITION LEADS  
FAISCEAUX DE BOUGIE ANTIPARASITAIRES**
**83120**

PEUGEOT	
205 1.9 GTI	1987-89
309 1.9 GTI	1987-89
405 1.9 GLI	1991-93

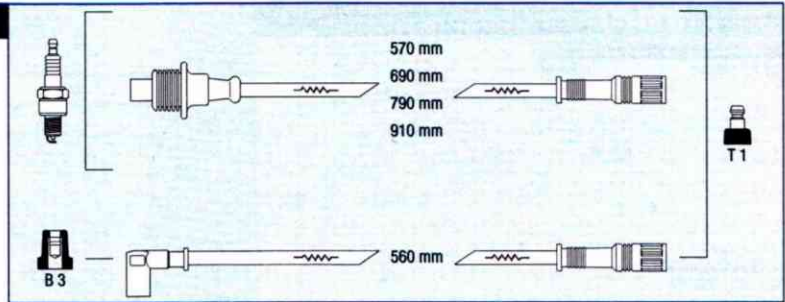
 Motores/Engines/Moteurs:  
XU9JA.

**83130**

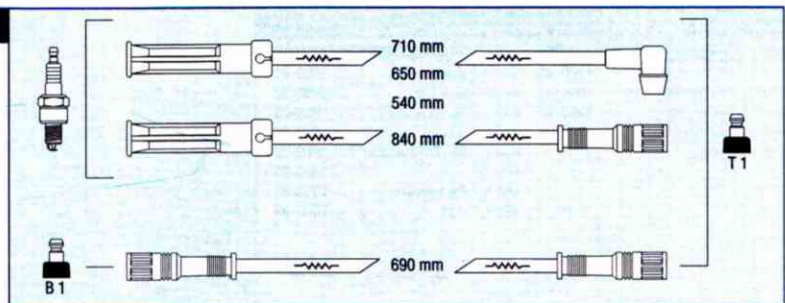
CITROËN		PEUGEOT	
BX 19 GTI (XU9J2)	1987-93	405 GRI, SRI, GTX, (XU9J2)	1987-91
XM 2.0 i BVM ->PR-4935	1989-90	605 2.0i (XU10J2) RFZ, R6A	1990-91
XM 2.0 i BVA	1989-94		

**83300**

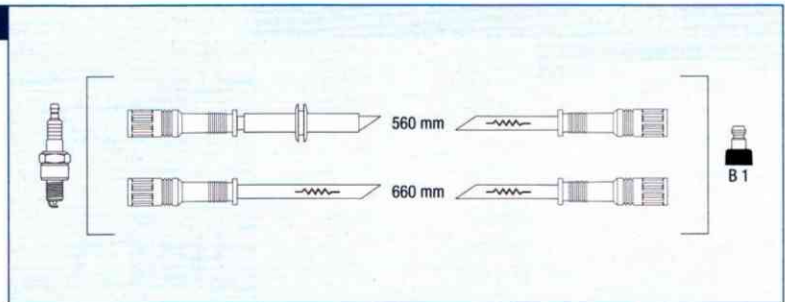
CITROËN	
2 CV, 3CV, Break, Azam	1965-90
Ami-6, Ami-8, C-8	1967-80
Dyane 4, Dyane 6, Dynam	1967-82
LNA 652 cc, 2 cil.	1982-86
Mehari (E)	1968-88
Visa II Special, Club, 652 cc.	1981-85

**83310**

CITROËN	
BX 15 RE, TGE. ->PR-4710	1990-91
BX 16 1580 cc. ->PR-4157	1987-89
BX 16 1580i Export XT	1987-89
BX 19 1905 cc. ->PR-4578	1987-89
Visa GTI PR-3522 ->	1987-89

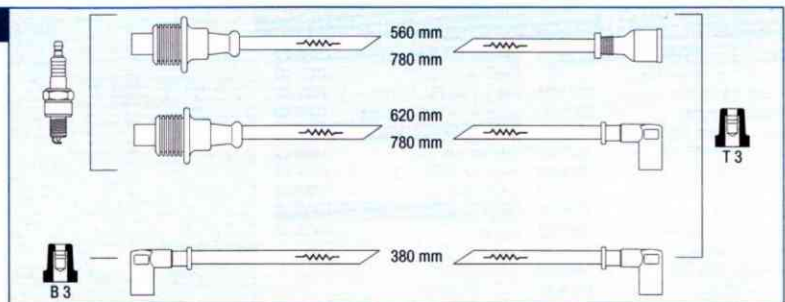
**83320**

CITROËN		PEUGEOT	
BX 15 RE, TGE. PR-4711->	1991-93	309 1.6 (XU52C)	1987-93
BX 16 TS, GTS. PR-4158->	1990-93	309 1.6 i (XU5M)	1989-91
BX 19 TGS PR-4579 ->	1990-93	309 1.9 GT, SX, (XU92C)	1987-93
BX 19 1905i Export (XT)	1987-93	309 1.9 i 110 cv. (XU9M)	1989-91
		405 1.6 (XU52C)	1987-93
		405 1.6 i GLI (XU5M)	1989-91
		405 1.9 (XU92C)	1987-93
		405 1.9 i 112 cv. (XU9JAZ)	1987-89
		405 1.9 i 110 cv. (XU9M)	1989-93

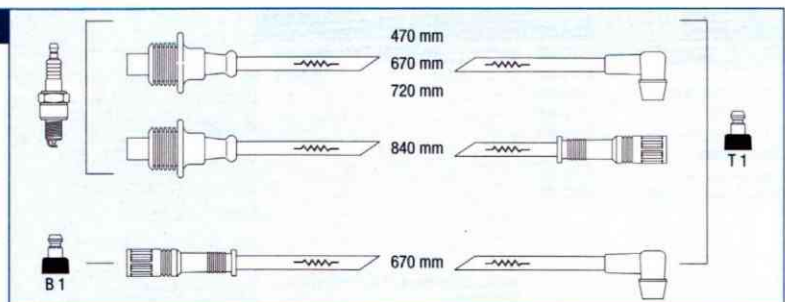
**IMPORTANTE:**

Al pedir accesorios eléctricos, rogamos completen la referencia comenzando por 'F' (ejemplo: 381394 → F381394)

Pour commander accessoires électriques, nous vous prions de compléter la référence en commençant par 'F'.

When ordering electric accessories, please complete the reference by beginning with 'F'.



## ACCESORIOS ELÉCTRICOS

## ACCESSOIRES ELECTRIQUES / ELECTRIC ACCESSORIES



**CABLES BUJIAS ANTIPARASITARIOS**  
**SUPPRESSOR IGNITION LEADS**  
**FAISCEAUX DE BOUGIE ANTIPARASITAIRES**

### 83330

CITROËN		PEUGEOT	
Evasion 2.0 i X, SX	1994-02	306 2.0 i XSI	1993-97
Evasion 2.0 i Turbo	1994-02	405 1.9 i 123 cv (D6D)	1991-93
Xantia 2.0 i SX, VSX	1993-97	405 2.0 i	1993-96
Xantia 2.0 i Turbo	1995-96	406 2.0 i Turbo	1996-99
XM 2.0 i BVM PR-4936->	1990-94	605 2.0 i SRI, SVI	1990 ->
XM 2.0 i Export (XT)	1990-94	605 2.0 i SRTI, SVTI	1991 ->
XM 2.0 i Turbo CT	1993-00	806 2.0 i SR, ST	1994-99
ZX 2.0 i Volcane	1992-96	806 2.0 i Turbo ST, SV	1994 ->

Motores/Engines/Moteurs:  
 XU10J2, XU10J2C  
 XU10J2Z, XU10J2TE.

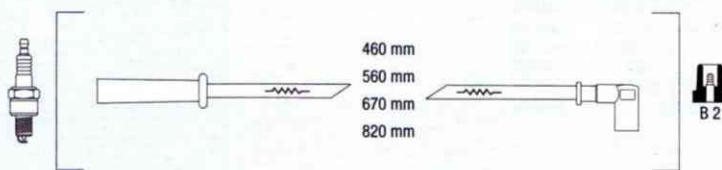

### 83340

PEUGEOT	
404	1960-75
504	1972-82
J 7. J 9	-> 1986

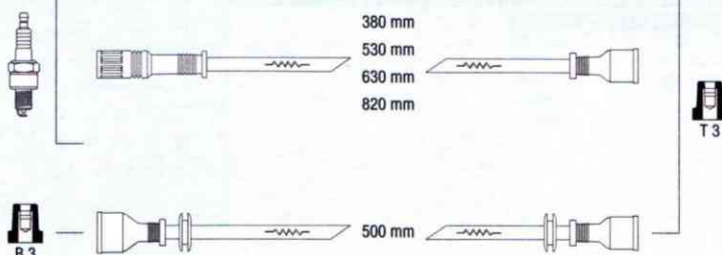

### 83360

CITROËN	
BX 16 RS, TRS, (90 cv.)	1983-87
BX 19 GT, TRS, Sport	1984-87
LNA 4 cil.	1981-84
Visa II Special, Club, 4 cil.	1981-84
Visa II 1124 cc.	1981-84

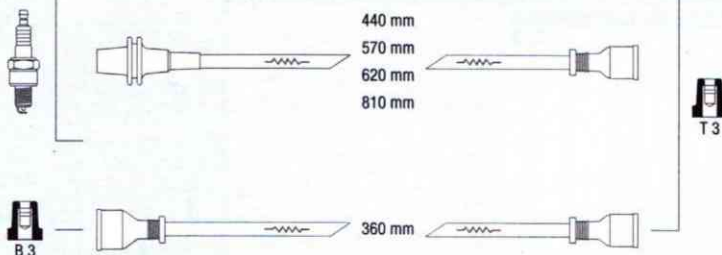

### 83370

PEUGEOT		SIMCA	
104	1980-84	1307, 1308	1975-86
205 GL, GR, GT, SR, XL (E)	1984-89	1309 SX	1978-86
205 1.3 SR, XR, (G1), (E)	1988-92	1510, 1510 SX	1979-86
205 1.6 GTX (J2), (E)	1988-92	<b>TALBOT-CHRYSLER</b>	
304 (XL3, XL3S)	1969-80	Horizon	1978-86
309 1.1, 1.3, 1.5, 1.6, (E)	1986-89	Solara LS, GLS, SX	1980-84
<b>LAND ROVER SANTANA</b>		150 GL, GLS, GT, LS, S, SX	1977-86

Land Rover 4 cil.

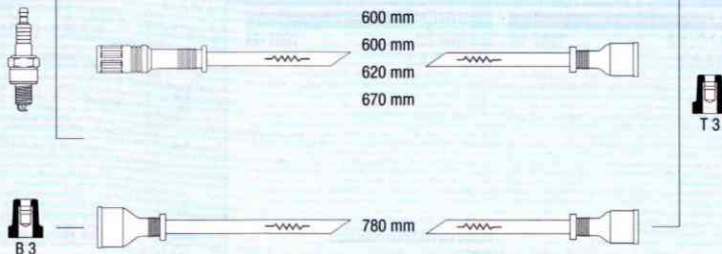

### 83380

CITROËN		PEUGEOT	
BX 16 1580i Export (XT)	1989-91	205 1.6 GTI, CTI, (XU)	1985-89
		205 Automatics	1985-89
		305 1.6, 1.9, 1.9 i	1987-88
		309 1.6, 1.9, GT, (XU)	1986-89
		309 1.6 GRI, SRI, GTI	1987-90
		309 1.6 i (XU5J)	1987-90
		309 Automatics	1986-90
		405 1.9 GLI, GRI, SRI	1987-90
		405 1.9 i (XU9J1)	1987-90

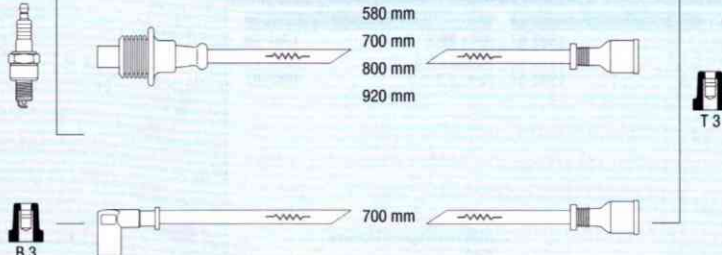

### IMPORTANTE:

Al pedir accesorios eléctricos, rogamos completen la referencia comenzando por 'F' (ejemplo: 381394 → F381394)  
 Pour commander accessoires électriques, nous vous prions de compléter la référence en commençant par 'F'.  
 When ordering electric accessories, please complete the reference by beginning with 'F'.

**ACCESORIOS ELÉCTRICOS**
**ACCESSOIRES ELECTRIQUES / ELECTRIC ACCESSORIES**

**CABLES BUJIAS ANTIPARASITARIOS  
SUPPRESSOR IGNITION LEADS  
FAISCEAUX DE BOUGIE ANTIPARASITAIRES**
**83630**

CITROËN	
C 15 E	1984-87
LNA 11 E, RE, RS	1982-86
Visa 11 E, RE	1982-89
Visa 14 TRS, GT	1982-89

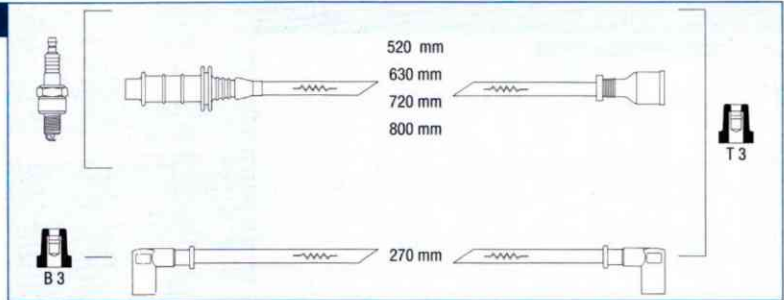
**83640**

CITROËN	
CX	1975-89

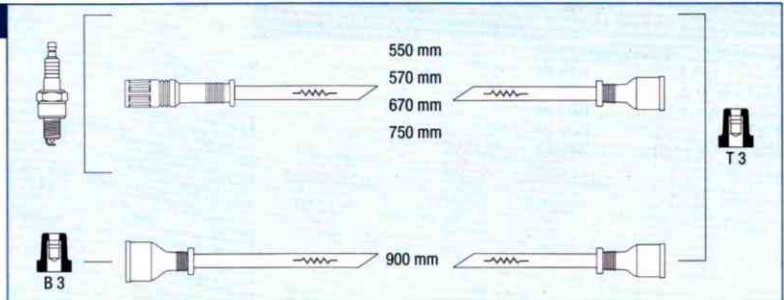
**83650**

CITROËN		PEUGEOT Cont.	
AX 10, AX 11	1987-92	205 1.2 i, 1.4 i	1988-94
AX 14, AX GT	1987-92	306 1.4 (TU3)	1992-93
AX 1.0 i (TU9M)	1995-96	309 GE, GR, XE, XA, Profil	1987-93
BX, BX 14, 1360 cc.	1988-93	309 1.1 i, 1.3 i	1989-93
C 15 E	1988-96	405 1.4 GL, GR	1987-93
ZX 1.1, 1.4, Carb.	1991-93	Ranch 1.4	1996 ->
ZX 1.4 i -> PR-5904	1992-93		

PEUGEOT	
106 954-1124-1360 cc.	1991-93
106 1.1 i (TU1M)	1991-92
106 1.3 i (KDY)	1991-92
205 954-1124-1294-1360	1987-93

**83810**

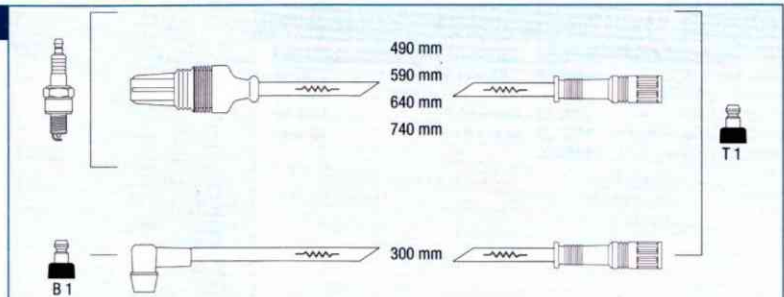
PEUGEOT	
505 GTI, STI	1981-91
505 2.0 i	1984-91
505 2.2 i	1979-89

**85010**

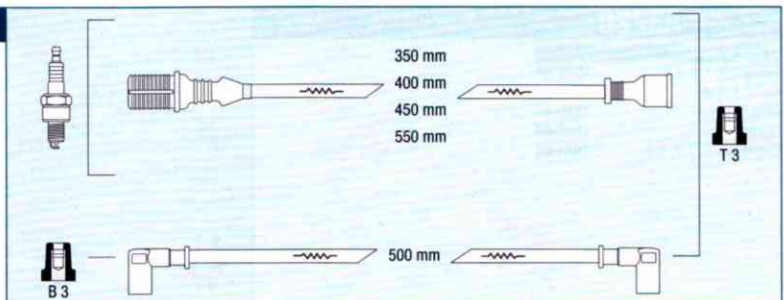
CITROËN		PEUGEOT	
Berlingo 1.8 i (XU7JB)	1997 ->	Boxer 2.0 i (XU10J2C)	1994 ->
Jumper 2.0 i (XU10J2C)	1994-02	Expert 1.6 i (XU5JP)	1995-00
Jumpy 1.6 i (XU5JP/Z)	1995 ->	Partner 1.8 i	1997 ->
Xantia 1.6 i X (XU5JP)	1993-98	205 1.6 i (XU5M)	1991-94
Xantia 1.8 i SX (XU7JP)	1993-03	306 1.8 i XT (XU7JP)	1992-02
XSara 1.8 i (XU7JP)	1997-00	309 1.6 i GL, GR, SR, SX	1992-93
ZX 1.6 i (XU5JP)	1991-96	405 1.6 i GL, GR, SR, Break	1992-96
ZX 1.8 i Aura, Sport	1992-96	405 1.8 i GL, Break (XU7JP)	1993-96
ZX 1.9 i Volcane	1991-92	406 1.6 i (XU5JP)	1996-04

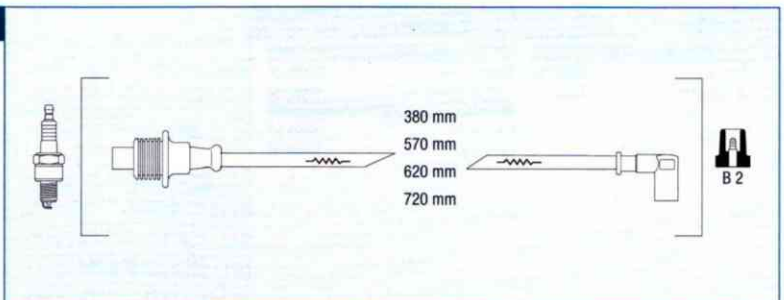
**IMPORTANTE:**

Al pedir accesorios eléctricos, rogamos completen la referencia comenzando por 'F' (ejemplo: 381394 → F381394)  
 Pour commander accessoires électriques, nous vous prions de compléter la référence en commençant par 'F'.  
 When ordering electric accessories, please complete the reference by beginning with 'F'.



## ACCESORIOS ELÉCTRICOS

## ACCESSOIRES ELECTRIQUES / ELECTRIC ACCESSORIES



**CABLES BUJIAS ANTIPARASITARIOS**  
**SUPPRESSOR IGNITION LEADS**  
**FAISCEAUX DE BOUGIE ANTIPARASITAIRES**
**85150**

CITROËN		PEUGEOT	
AX 954 i, 1.1 i, 1.4 i	1992-93	106 1.0, 1.1, 1.4	1992-93
AX GTI 1360 cc.	1991-93	106 1.3 i KDX	1992-93
ZX 1.4 i PR-5905 ->	1992-93	106 XSI (TU3FJ)	1991-93
		205 1.0 i, 1.1 i	1991-94
		205 1.1 i, 1.4 i	1993-93
		306 1.6 i XR, XS, XT	1993-93
		405 1.4 i GL	1993-93

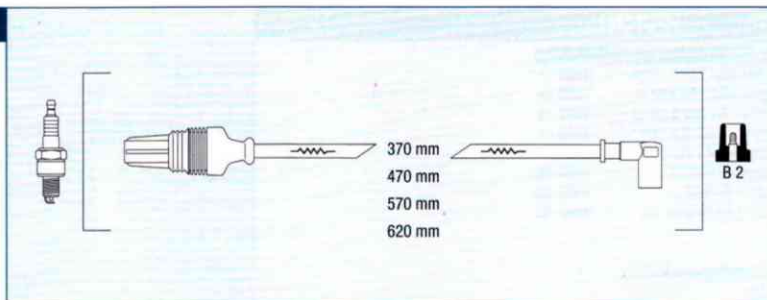
Motores/Engines/Moteurs:  
TU1M, TU3M, TU9M. Injection  
Monopoint.

**85160**

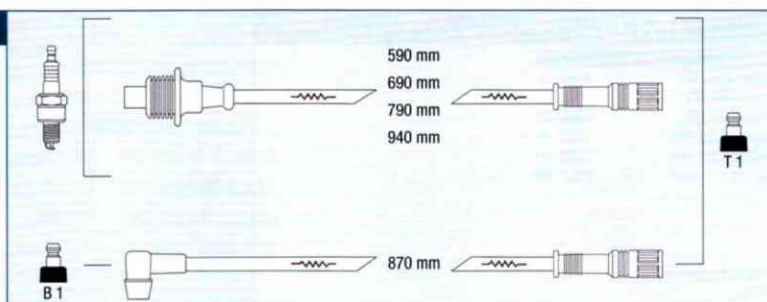
CITROËN		PEUGEOT	
BX 16 i Export (XT) 4741->	1991-93	205 1.6 GTI (XU5J,XU5JA)	1990-94
ZX 1.9 i Export (XT)	1991-96	205 1.9 GTI (XU9JA/AZ)	1990-94
		309 1.6 GTI (XU5JA)	1990-93
		309 1.9 GTI (XU9JA/AZ)	1990-93
		405 1.9 i 122 cv. (XU9JAZ)	1989-93

**85180**

CITROËN		PEUGEOT	
BX GTI 16V	1988-93	309 GTI 16V	1988-93
		405 MI 16V	1988-93

Motores/Engines/Moteurs:  
XU9J4.

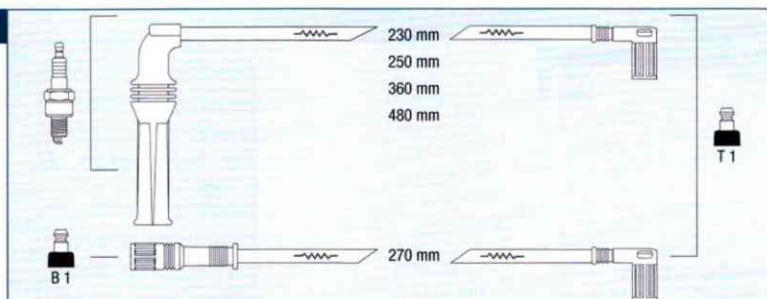
**85190**

CITROËN		PEUGEOT	
C 25 E	1985-92		
505 GL, GR, SR	1980-89		
505 2.0 (XN1A)	1980-89		
J 5, J 9	1984-94		

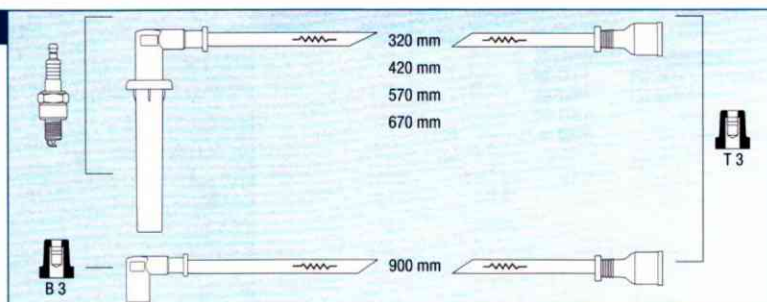
**85420**

CITROËN		PEUGEOT	
2 CV (F)	1983-90		
Acadiane 2 cil.	1983-87		
Mehari 2 cil. (F)	1983-87		

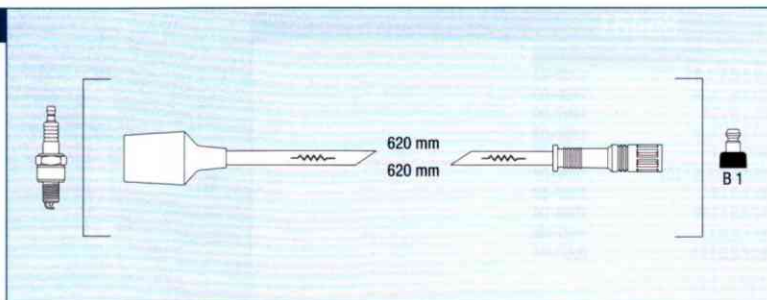
**IMPORTANTE:**

Al pedir accesorios eléctricos, rogamos completen la referencia comenzando por 'F' (ejemplo: 381394 → F381394)  
 Pour commander accessoires électriques, nous vous prions de compléter la référence en commençant par 'F'.  
 When ordering electric accessories, please complete the reference by beginning with 'F'.

**ACCESORIOS ELÉCTRICOS**
**ACCESSOIRES ELECTRIQUES / ELECTRIC ACCESSORIES**

MATERIAL ELECTRICO / MATERIEL ELECTRIQUE / ELECTRIC PARTS

**CABLES BUJIAS ANTIPARASITARIOS**  
**SUPPRESSOR IGNITION LEADS**  
**FAISCEAUX DE BOUGIE ANTIPARASITAIRES**
**85600**

CITROËN		PEUGEOT	
AX 1.0 i, 1.1 i	1993-96	106 1.0 i XA, SN, Zenith	1993 ->
AX 1.4 i GTI, GTS	1992-96	106 1.1 i XA, XN, XR, XT	1993 ->
Berlingo 1.1 i X (TU1M+)	1996 ->	106 1.3 i (TU2J2)	1993-96
Berlingo 1.4 i X, SX. (TU3JP)	1996 ->	106 1.4 i XR, XS, XT	1993-96
Saxo 1.0 i X (TU9M)	1996 ->	106 1.4 i XSi, Rallye	1993-96
Saxo 1.1 i X, SX. (TU1M)	1996 ->	106 1.6 i (TU5JP)	1996 ->
Saxo 1.4 i SX, VSX. (TU3JP)	1996 ->	106 1.6 i Rallye (TU5J2)	1992 ->
Saxo 1.6 i VTL (TU5JP)	1996 ->	205 1.1 i, 1.4 i. (TU)	1993-94
XSara 1.4 i LS, SX. (TU3JP)	1997-05	306 1.1 i, 1.4 i, 1.6	1993-01
XSara 1.6 i LX, SX, Exclusive	1997-00	309 1.4 i (TU)	1993-93
ZX 1.1 i (TU1M) PR-6367->	1993-96	405 1.4 i (TU3FM)	1994-96
ZX 1.4 i (TU3MC)	1993-96	Partner 1.1 i, 1.4 i	1996 ->

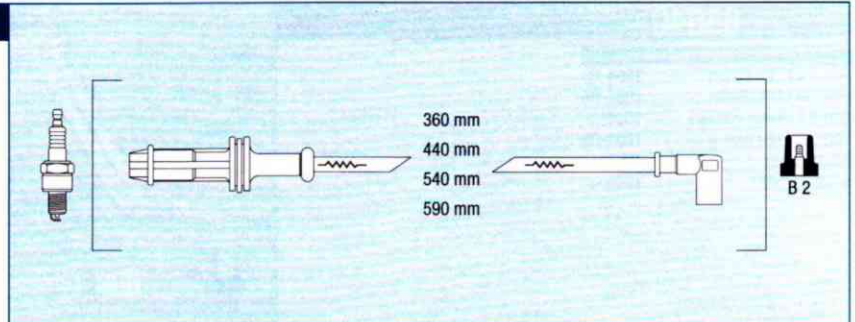
**IMPORTANTE:**
**Al pedir accesorios eléctricos, rogamos completen la referencia comenzando por 'F' (ejemplo: 381394 → F381394)**
*Pour commander accessoires électriques, nous vous prions de compléter la référence en commençant par 'F'.*

When ordering electric accessories, please complete the reference by beginning with 'F'.



## ACCESORIOS ELÉCTRICOS

## ACCESSOIRES ELECTRIQUES / ELECTRIC ACCESSORIES



RACCORDS, INDICADORES, KITS  
ADAPTORS, GAUGES, KITS  
RACCORDS, INDICATEURS, KITS

99700

CITROËN

Kit manómetro aceite.  
Oil gauge kit.  
Kit manometre d'huile

Aro negro.  
Black frame.  
Cache noir.

Racord de montage ver pág. 31.0  
Adaptor joint see page 310.  
Raccord d'adaptation voir page 310.

ENVASADO EN CAJA EXPOSITORIA.  
PACKED IN SEE-THROUGH CARTON.  
ENVELOPPE EXHIBITEUR.



6,35 mm



Reemplaza / Suitable:



14x1,5 52 mm

0 - 6  
12 V

99800

CITROËN

Kit termómetro agua.  
Water temperature gauge kit.  
Kit temperature d'eau

Aro negro.  
Black frame.  
Cache noir.

ENVASADO EN CAJA EXPOSITORIA.  
PACKED IN SEE-THROUGH CARTON.  
ENVELOPPE EXHIBITEUR.



6,35 mm



Reemplaza / Suitable:



18x1,5 52 mm

40 ° - 120 °  
12 V

99820

PEUGEOT

TALBOT-SIMCA

Kit termómetro agua.  
Water temperature gauge kit.  
Kit temperature d'eau

Aro negro.  
Black frame.  
Cache noir.

ENVASADO EN CAJA EXPOSITORIA.  
PACKED IN SEE-THROUGH CARTON.  
ENVELOPPE EXHIBITEUR.



6,35 mm



Reemplaza / Suitable:



14x1,25 52 mm

40 ° - 120 °  
12 V

## IMPORTANTE:

Al pedir accesorios eléctricos, rogamos completen la referencia comenzando por 'F' (ejemplo: 381394 → F381394)

*Pour commander accessoires électriques, nous vous prions de compléter la référence en commençant par 'F'.*

When ordering electric accessories, please complete the reference by beginning with 'F'.



Adaptable to **Citroën- Peugeot** not original parts

**ACCESORIOS ELÉCTRICOS**

**ACCESOIRES ELECTRIQUES / ELECTRIC ACCESSORIES**



MATERIAL ELECTRICO / MATERIEL ELECTRIQUE / ELECTRIC PARTS



**CRUCE DE REFERENCIAS  
CROSS REFERENCES  
TABLEAU DES EQUIVALENCES**

**CRUCE REFERENCIAS  
CROSS REFERENCES  
TABLEAU DES EQUIVALENCES**





## ACCESORIOS ELÉCTRICOS

## ACCESSOIRES ELECTRIQUES / ELECTRIC ACCESSORIES

**CRUCE DE REFERENCIAS  
CROSS REFERENCES  
TABLEAU DES EQUIVALENCES**

CITROEN	FAE	CITROEN	FAE	CITROEN	FAE	CITROEN	FAE	CITROEN	FAE
Ver también / See		5.453.674	<b>37410</b>	91.541.075	<b>79033</b>	96.015.494	<b>37400</b>	96.366.522.80	<b>77280</b>
also / Voir aussi		5.454.205	<b>41070</b>	92.503.165	<b>67210</b>	96.018.108	<b>40650</b>	96.368.023	<b>33705</b>
PEUGEOT-PSA		5.458.592	<b>83640</b>	94.491.301 E	<b>40340</b>	96.018.110	<b>40570</b>	96.368.027	<b>33795</b>
0042790300	<b>31370</b>	5.460.577	<b>10200</b>	94.633.276	<b>33510</b>	96.018.422	<b>34050</b>	96.369.683	<b>77240</b>
0242.18	<b>35130</b>	5.463.397	<b>37400</b>	95.492.854	<b>37400</b>	96.018.426	<b>32290</b>	96.369.684	<b>77241</b>
0242.33	<b>35130</b>	5.464.665	<b>12250</b>	95.492.930	<b>12290</b>	96.018.427	<b>34120</b>	96.369.685	<b>77242</b>
0926001 A	<b>40340</b>	5.465.759	<b>35150</b>	95.493.206	<b>74140</b>	96.019.305	<b>37850</b>	96.369.687.80	<b>77281</b>
1628.KN	<b>77281</b>	5.472.060	<b>24130</b>	95.493.258	<b>37390</b>	96.026.617	<b>12460</b>	96.372.208.80	<b>79148</b>
1628.YK	<b>77281</b>	5.474.578	<b>67210</b>	95.493.608	<b>35130</b>	96.027.244	<b>77387</b>	96.374.991.80	<b>79147</b>
5.403.215	<b>12280</b>	5.474.985	<b>12170</b>	95.493.610	<b>83360</b>	96.029.641	<b>37310</b>	96.389.858	<b>74167</b>
5.403.215 Y	<b>10200</b>	5.476.771	<b>62540</b>	95.493.611	<b>83360</b>	96.033.248	<b>33792</b>	96.393.054	<b>77241</b>
5.412.349	<b>37320</b>	5.490.353	<b>83640</b>	95.493.782	<b>67210</b>	96.037.097	<b>79033</b>	96.399.998.80	<b>79118</b>
5.413.327	<b>31020</b>	5.490.542	<b>37400</b>	95.493.861	<b>11260</b>	96.039.131	<b>24080</b>	96.399.999.80	<b>79119</b>
5.418.467	<b>37320</b>	5.490.703	<b>67210</b>	95.493.978	<b>62190</b>	96.040.821	<b>24440</b>	96.406.277.80	<b>79117</b>
5.420.474	<b>25020</b>	5.490.801	<b>12250</b>	95.494.103	<b>11250</b>	96.042.609	<b>85170</b>	96.423.813.80	<b>77281</b>
5.422.483	<b>24130</b>	5.490.843	<b>62540</b>	95.494.194	<b>40340</b>	96.048.371	<b>62640</b>	96.434.788	<b>24898</b>
5.434.394	<b>41070</b>	5.491.301	<b>40340</b>	95.494.332	<b>24130</b>	96.064.561	<b>37580</b>	96.506.884	<b>24899</b>
5.435.033	<b>37330</b>	5.502.135	<b>83300</b>	95.494.812	<b>24070</b>	96.064.750	<b>37930</b>	96.544.141.80	<b>33706</b>
5.446.115	<b>37410</b>	5.508.282	<b>10200</b>	95.494.830	<b>31020</b>	96.067.317	<b>79154</b>	96.566.364	<b>33707</b>
5.452.407	<b>35150</b>	5.962.008	<b>74140</b>	95.495.141	<b>62590</b>	96.068.168	<b>79033</b>	96.629.066.80	<b>40491</b>
		75.413.327	<b>31020</b>	95.495.159	<b>12250</b>	96.070.388	<b>74142</b>	97.509.510	<b>31370</b>
		75.413.615	<b>12250</b>	95.495.376	<b>12170</b>	96.070.983	<b>83130</b>	97.513.687	<b>62580</b>
		75.454.205	<b>41070</b>	95.495.385	<b>37800</b>	96.070.995	<b>85160</b>	97.516.535.80	<b>14500</b>
		75.460.576	<b>12170</b>	95.495.530	<b>24070</b>	96.076.258	<b>74142</b>	97.518.408	<b>14500</b>
		75.465.759	<b>35150</b>	95.495.551	<b>12290</b>	96.082.965 ZL	<b>62660</b>	97.532.087	<b>83650</b>
		75.474.578	<b>67210</b>	95.495.591	<b>35170</b>	96.085.170	<b>79034</b>	97.532.198	<b>83320</b>
		75.474.985	<b>12170</b>	95.495.592	<b>35180</b>	96.085.909	<b>37940</b>	97.534.955	<b>83380</b>
		75.490.468	<b>35150</b>	95.495.900	<b>83630</b>	96.086.050	<b>85150</b>	97.535.465	<b>85180</b>
		75.490.801	<b>12250</b>	95.511.279.80	<b>12260</b>	96.088.851	<b>83330</b>	AY-57602-A	<b>25020</b>
		75.491.289	<b>41070</b>	95.534.788	<b>74140</b>	96.089.138	<b>34090</b>	AY-9576902-A	<b>25020</b>
		75.491.858	<b>24130</b>	95.543.583	<b>37340</b>	96.092.918	<b>35550</b>	AYB-614112-A	<b>10200</b>
		75.491.868	<b>83300</b>	95.544.513	<b>67210</b>	96.094.933	<b>85010</b>	GX-0147702-A	<b>12170</b>
		75.492.054	<b>12290</b>	95.546.426	<b>35130</b>	96.099.747	<b>85010</b>	GX-0147703-A	<b>12170</b>
		75.492.645	<b>37310</b>	95.548.678	<b>31020</b>	96.099.749	<b>83330</b>	GX-0192601-A	<b>40340</b>
		75.503.370	<b>40340</b>	95.556.508	<b>11250</b>	96.121.278	<b>77126</b>	GX-0612301-C	<b>83600</b>
		75.503.377	<b>40340</b>	95.561.517	<b>83600</b>	96.123.564	<b>37680</b>	GX-0926001-A	<b>40340</b>
		75.524.946	<b>83300</b>	95.562.366	<b>11260</b>	96.127.346	<b>77126</b>	ZF-04.345.643	<b>24010</b>
		77 00 591 730	<b>41090</b>	95.565.629	<b>24070</b>	96.127.817	<b>77126</b>	ZF-04.345.645	<b>24010</b>
		77 00 655 787	<b>11410</b>	95.566.070	<b>31020</b>	96.128.754	<b>36650</b>	ZF-04.475.634	<b>37460</b>
		79 10 010 888	<b>37340</b>	95.571.231	<b>62590</b>	96.131.470	<b>33120</b>	ZF-05.934.064	<b>37890</b>
		79 10 013 785	<b>35130</b>	95.576.325	<b>37800</b>	96.138.608	<b>77127</b>		
		79 10 014 016	<b>35130</b>	95.578.666	<b>24070</b>	96.138.637	<b>37680</b>		
		79 10 014 017	<b>35130</b>	95.578.879	<b>12290</b>	96.140.044.80	<b>79152</b>		
		79 10 017 566	<b>24080</b>	95.579.683	<b>35170</b>	96.141.678	<b>74140</b>		
		79 10 033 004	<b>35130</b>	95.579.684	<b>35180</b>	96.142.336	<b>35610</b>		
		79 10 033 005	<b>35130</b>	95.581.212	<b>31020</b>	96.161.266	<b>83330</b>		
		79 10 033 055	<b>35130</b>	95.581.882	<b>83300</b>	96.164.554	<b>32380</b>		
		79 10 033 931	<b>24080</b>	95.584.562	<b>83300</b>	96.164.556	<b>33400</b>		
		79 10 247 507	<b>30260</b>	95.591.148	<b>12260</b>	96.165.724	<b>74140</b>		
		79 20 017 929	<b>67210</b>	95.602.510	<b>24080</b>	96.165.734	<b>74151</b>		
		79 46 000 030	<b>12260</b>	95.607.323	<b>83630</b>	96.168.062.80	<b>79152</b>		
		90.041.002	<b>74142</b>	95.611.003	<b>62650</b>	96.168.063.80	<b>79153</b>		
		91.040.130	<b>11270</b>	95.611.529	<b>37340</b>	96.170.510	<b>34240</b>		
		91.500.881	<b>24080</b>	95.612.640	<b>37800</b>	96.228.897	<b>80207</b>		
		91.506.431	<b>24080</b>	95.630.939	<b>37810</b>	96.229.969	<b>77211</b>		
		91.511.279.80	<b>12260</b>	95.631.379	<b>33660</b>	96.229.970	<b>77166</b>		
		91.513.244	<b>41090</b>	95.632.734	<b>37330</b>	96.229.971	<b>77210</b>		
		91.513.310.80	<b>35230</b>	95.635.573	<b>30290</b>	96.236.383	<b>74167</b>		
		91.514.017	<b>41090</b>	95.636.601	<b>83310</b>	96.246.755.80	<b>80208</b>		
		91.514.046	<b>37340</b>	95.636.605	<b>83310</b>	96.273.896	<b>33510</b>		
		91.514.432.80	<b>12260</b>	95.638.684	<b>37920</b>	96.281.585.80	<b>80226</b>		
		91.514.549	<b>33010</b>	95.640.493	<b>33070</b>	96.284.479	<b>77211</b>		
		91.514.733	<b>41090</b>	95.640.497	<b>33180</b>	96.284.482	<b>77167</b>		
		91.515.141	<b>37340</b>	95.649.419.4F	<b>40340</b>	96.285.598.80	<b>79151</b>		
		91.516.467	<b>37810</b>	95.659.593	<b>85420</b>	96.291.398.80	<b>79150</b>		
		91.517.505	<b>30280</b>	95.659.596	<b>83380</b>	96.310.010	<b>33795</b>		
		91.517.674	<b>37850</b>	96.001.647	<b>24080</b>	96.324.005.80	<b>79116</b>		
		91.519.272	<b>35180</b>	96.005.949	<b>24080</b>	96.325.624.80	<b>33706</b>		
		91.521.111	<b>11650</b>	96.008.159	<b>35290</b>	96.328.897.80	<b>79120</b>		
		91.521.112	<b>11250</b>	96.009.503	<b>37570</b>	96.332.143	<b>74140</b>		
		91.521.113	<b>11270</b>	96.009.783	<b>74142</b>	96.334.757.80	<b>79135</b>		
		91.521.849	<b>74140</b>	96.009.875	<b>83130</b>	96.335.188	<b>33790</b>		
		91.521.918	<b>74140</b>	96.012.089	<b>35260</b>	96.346.055.80	<b>79149</b>		
		91.536.646	<b>74140</b>	96.012.473	<b>83320</b>	96.346.679	<b>24897</b>		
		91.538.910	<b>74142</b>	96.012.732	<b>83650</b>	96.346.679.80	<b>24897</b>		
		91.541.027	<b>79051</b>	96.013.114	<b>83320</b>	96.357.329.80	<b>79114</b>		

**IMPORTANTE:**

Al pedir accesorios eléctricos, rogamos completen la referencia comenzando por 'F' (ejemplo: 381394 → F381394)

Pour commander accessoires électriques, nous vous prions de compléter la référence en commençant par 'F'.

When ordering electric accessories, please complete the reference by beginning with 'F'.



## ACCESORIOS ELÉCTRICOS

## ACCESSOIRES ELECTRIQUES / ELECTRIC ACCESSORIES

 CRUCE DE REFERENCIAS  
 CROSS REFERENCES  
 TABLEAU DES EQUIVALENCES

PEUGEOT-PSA	FAE	PEUGEOT-PSA	FAE	PEUGEOT-PSA	FAE	PEUGEOT-PSA	FAE	PEUGEOT-PSA	FAE
0242.10	37350	0242.86	35290	1338.77	32295	1920.EJ	79147	5962.2Y	74151
0242.11	37420	0313.02	12260	1338.78	33190	1920.EN	79117	5962.2Z	74151
0242.12	37350	1131.04	12260	1338.85	34430	1920.F5	79154	5962.35	74140
0242.14	31020	1131.05	12270	1338.86	34460	1920.FA	79001	5962.3C	74167
0242.18	35130	1131.09	11410	1338.87	33791	1920.FP	79117	5962.3E	74167
0242.20	30260	1131.10	12270	1338.88	33705	1920.J5	79034	5962.3H	74140
0242.24	35220	1131.11	35190	1338.91	33770	1920.K9	33120	5962.3J	74140
0242.25	35210	1131.12	11260	1338.97	33795	1920.KP	33255	5962.4J	74145
0242.26	35180	1131.14	11270	1338.A5	33200	1920.L1	79102	5962.4K	74146
0242.30	35170	1131.16	35230	1338.A6	33795	1920.O2	33400	5962.4L	74153
0242.32	35200	1131.19	12160	1338.A7	33705	1920.T0	33185	5962.74	74140
0242.33	35130	1131.25	12170	1338.C0	33790	1920.W9	79033	5962.7F	74167
0242.36	35130	1131.26	14500	1338.C1	33706	1920.Y9	79054	5962.7Z	74141
0242.39	35170	1131.27	14500	1338.F3	33707	1920.Z3	79034	5962.J2	74161
0242.40	31020	1131.38	12340	1338.F8	33707	2044.04	37350	5962.J3	74142
0242.41	35210	1131.41	12150	1628.1G	77127	2257.12	40270	5962.J4	74140
0242.43	35170	1131.44	11650	1628.34	77387	2257.17	41090	5962.J5	74140
0242.45	35150	1131.45	11630	1628.3W	77126	2257.22	41070	5962.J6	74140
0242.46	33010	1131.48	12260	1628.6R	77211	2257.33	40650	5962.J7	74141
0242.49	35180	1131.54	11620	1628.6S	77166	2257.34	40570	5962.K5	74140
0242.50	30280	1131.61	12460	1628.6W	77210	2257.40	40570	5962.R8	74140
0242.51	35180	1131.78	34240	1628.7R	77165	2257.41	40650	5962.S8	74140
0242.61	33660	1131.80	34250	1628.7S	77162	2257.42	40492	5962.T1	74161
0242.63	31280	1131.82	12460	1628.8C	77369	2257.43	40491	5962.T2	74141
0242.64	32280	1131.98	12430	1628.9A	77163	2257.53	40492	5962.T3	74175
0242.68	34110	1131.C5	12640	1628.9S	77210	2257.59	40491	5962.T7	74142
0242.72	35260	1131.C7	12430	1628.9T	77167	4534.04	24080	5962.W2	74151
0242.73	35130	1264.03	37340	1628.9V	77166	4532.02	24080	5962.W3	74151
0242.76	35550	1264.04	37420	1628.9W	77211	4534.02	24080	5962.W8	74140
0242.77	35295	1264.05	37320	1628.AA	77164	4534.04	24080	5962.X1	74140
0242.78	35290	1264.06	37320	1628.CP	77163	4534.06	24010	5967.06	83340
0242.81	32440	1264.09	37320	1628.CW	77282	4534.08	24100	5967.07	83340
0242.83	34440	1264.10	37890	1628.CX	77242	4534.09	24340	5967.12	83340
0242.85	34110	1264.11	37460	1628.EC	77284	4534.11	24440	5967.19	83340
		1264.12	37320	1628.HN	77283	4534.13	24080	5967.20	83340
		1264.13	37420	1628.HQ	77284	4534.15	24340	5967.21	83340
		1264.14	37340	1628.HR	77282	4534.25	24365	5967.22	83340
		1264.15	37320	1628.HT	77166	4534.27	24885	5967.23	83340
		1264.16	37810	1628.HV	77242	4534.28	24896	5967.24	83340
		1264.17	37800	1628.J4	77387	4534.29	24660	5967.90	83810
		1264.18	37850	1628.KN	77281	4534.37	24885	5967.98	83370
		1264.20	37330	1628.KY	77240	4534.39	24411	5967.A6	83370
		1264.21	37400	1628.LP	77280	4534.40	24898	5967.C2	83120
		1264.22	37860	1628.NY	77240	4534.41	24400	5967.C3	83380
		1264.23	37570	1628.PL	77241	4534.43	24415	5967.C4	83380
		1264.24	37920	1628.PX	77241	4534.44	24897	5967.C7	85180
		1264.25	37930	1628.QY	77241	4534.45	24411	5967.C8	83650
		1264.26	37580	1628.R9	77127	4534.48	24899	5967.C9	83130
		1264.27	37940	1628.SW	77207	4534.51	24440	5967.E5	83320
		1264.29	36650	1628.T2	77127	4608.11	21060	5967.E9	83320
		1264.31	37680	1628.V4	77126	4608.13	21050	5967.G8	83320
		1264.32	37220	1628.YK	77281	4608.15	21050	5967.H1	83130
		1264.33	37910	1920.1J	33510	5968.56	62480	5967.H2	85170
		1264.34	37900	1920.3F	33600	5918.75	79156	5967.H5	83320
		1264.36	37920	1920.4A	79034	5918.80	79051	5967.H7	83130
		1264.37	37580	1920.4G	33510	5918.81	79033	5967.J5	83810
		1264.38	37930	1920.5T	79101	5918.87	79033	5967.K0	83370
		1264.40	37580	1920.5V	79100	5918.90	79033	5967.K3	83120
		1264.43	37680	1920.6C	33511	5918.91	79152	5967.K4	83320
		1264.44	37920	1920.6T	79104	5918.92	79158	5967.K5	83130
		1264.45	37930	1920.7N	79116	5918.93	79152	5967.K6	83650
		1264.50	36260	1920.7P	79135	5918.94	79153	5967.K7	83380
		1337.72	31370	1920.7V	79151	5960.64	74210	5967.K8	85160
		1338.09	32290	1920.8S	79120	5960.65	74210	5967.K9	85160
		1338.10	33792	1920.8W	79150	5961.39	74140	5967.L0	85010
		1338.27	35610	1920.8Y	33510	5961.40	74140	5967.L1	83330
		1338.33	34090	1920.9C	79114	5961.53	74140	5967.L2	85180
		1338.34	32380	1920.9F	33510	5961.54	74140	5967.L3	83330
		1338.40	35600	1920.AE	79149	5961.57	74140	5967.L5	85150
		1338.42	34425	1920.AV	79119	5961.58	74140	5967.L6	83330
		1338.43	34400	1920.AW	79118	5962.1P	74180	5967.L7	85010
		1338.47	33190	1920.C3	79033	5962.1Q	74180	5967.L8	83330
		1338.48	34435	1920.C4	33070	5962.1R	74140	5967.L9	85600
		1338.50	34410	1920.C5	33180	5962.1S	74142	5967.N1	83330
		1338.55	33792	1920.E2	79154	5962.1V	74140	5967.N2	85640
		1338.75	33770	1920.EH	79148	5962.1W	74142	5967.N6	85600

## IMPORTANTE:

Al pedir accesorios eléctricos, rogamos completen la referencia comenzando por 'F' (ejemplo: 381394 → F381394)

Pour commander accessoires électriques, nous vous prions de compléter la référence en commençant par 'F'.

When ordering electric accessories, please complete the reference by beginning with 'F'.



## ACCESORIOS ELÉCTRICOS

## ACCESSOIRES ELECTRIQUES / ELECTRIC ACCESSORIES



CRUCE DE REFERENCIAS  
CROSS REFERENCES  
TABLEAU DES EQUIVALENCES

PEUGEOT-PSA	FAE
5967.N9	83650
5967.P1	85600
5970.48	80207
5970.51	80237
5970.60	80207
5970.70	80207
5970.72	80226
5970.73	80237
5970.74	80226
5970.79	80208
5970.80	80235
6338.05	62060
6338.06	62060
6366.08	67210
6366.09	67210
6366.13	67210
6366.24	67210
6366.32	67180
6409.26	62130
6409.29	62150
6409.31	62150
6409.32	62210
6409.36	62150
6409.40	62130
6475.07	65280
6475.15	62070
6550.05	62550
6550.23	61510
6550.24	61520
6550.25	61540
6551.21	62580
6552.24	61550
6552.27	61530
6552.67	62640
6552.CZ	24370
6552.W5	24880
6609.03	62540
6910.68	67210
77 00 542 924	14580
77 00 557 802	62130
79 10 025 732	24070
79 10 033 004	35130
79 10 245 550	30260
79 10 247 507	30260
79 20 046 119	62190
79 32 568 137	35210
7932567717	74140
7932567718	74140
8225.08	67180
91 01 058 680	35130
91 50 094 680	35170
91 50 242 380	35130
91 51 927 280	35180
91 52 111 180	11650
9150771880	74140
9150860280	74140
9150861080	74140
9152184980	74140
9152191880	74140
9153664680	74140
95 54 642 680	35130
96346679	24897
MKD00066	74140
MKP00065	74140
MKP00070	70030

**IMPORTANTE:**

Al pedir accesorios eléctricos, rogamos completen la referencia comenzando por 'F' (ejemplo: 381394 → F381394)

*Pour commander accessoires électriques, nous vous prions de compléter la référence en commençant par 'F'.*

When ordering electric accessories, please complete the reference by beginning with 'F'.