

# TERMOSTATOS

## THERMOSTATS

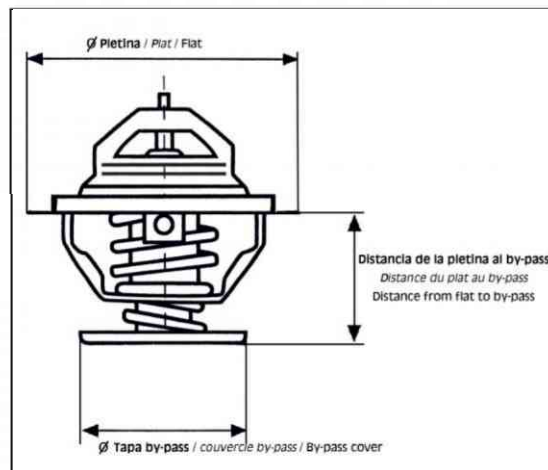

### LEYENDA / LEGENDE / EXPLANATION

.....Español.....Français.....English



## LISTE D'APPLICATIONS

APPLICATION LIST/ANWENDUNGSLISTE

VEHICULE MODEL FAHRZEUGTYP	MOTEUR ENGINE MOTOR	CYLINDRÉE ENGINE SIZE HUBRAUM	ANNÉE YEAR JAHR	NEUMARS A	PHOTOS PICTURES ZEICHUNGEN
----------------------------------	---------------------------	-------------------------------------	-----------------------	-----------	----------------------------------

### CITROEN

AX					
1.0	TU9	954	09/86>04/91	TER.V6148.89	
1.1	TU1	1124	05/91>07/96	TER.V6148.89	
1.3	TU2	1294	04/87>04/91	TER.V6148.89	
	TU24	1294	04/87>04/91	TER.V6148.89	
1.4	TU3	1360	09/86>12/88	TER.V6148.89	
1.4 D	TUD3	1360	09/88>07/94	TER.V1542.89	
1.5 D	TUD3	1527	07/94>07/96	TER.V1542.89	
	TUD5	1527	07/94>07/96	TER.V1542.89	

BX					
1.1	XW7	1124	09/82>04/88	TER.V5108.83	
	XW7 / TU1	1124	04/88>12/91	TER.V6148.89	
1.4	TU3	1360	12/86>12/94	TER.V6148.89	
	TU3	1360	07/88>12/94	TER.V5108.83	
	XY6 / XY7	1360	02/86>11/89	TER.V6148.89	
	XY6	1360	09/82>04/88	TER.V5108.83	

**TERMOSTATOS / THERMOSTATS**

**Liste d'Applications**

APPLICATION LIST/ANWENDUNGSLISTE

REFRIGERATION / REFRIGERATION































VEHICULE MODEL FAHRZEUGTYP	MOTEUR ENGINE MOTOR	CYLINDRÉE ENGINE SIZE HUBRAUM	ANNÉE YEAR JAHR	NEUMARS A	PHOTOS PICTURES ZEICHNUNGEN
<b>...BX</b>					
1.6	171	1580	09/82>11/89	<b>TER.V5108.83</b>	
	XU5	1580	09/82>12/94	<b>TER.V5108.83</b>	
1.7 D / TD	XUD7	1769	10/84>12/94	<b>TER.V5231.83</b>	
	XUD7	1769	05/88>12/94	<b>TER.V5130.83</b>	
1.9	XU9	1905	07/84>12/94	<b>TER.V5108.83</b>	
1.9 16S	XU9	1905	07/87>12/94	<b>TER.V1538.88</b>	
1.9 4x4	XU9	1905	09/86>12/94	<b>TER.V5108.83</b>	
1.9 D	XUD9	1905	07/83>12/94	<b>TER.V4947.81</b>	
	XUD9	1905	07/83>12/94	<b>TER.V5231.83</b>	
1.9 D 4x4	XUD9	1905	08/86>04/87	<b>TER.V5108.83</b>	
<b>C1 NEW</b>					
1.0	384F(CFA)	998	06/05>	<b>TER.V6950.82</b>	
1.4 HDi	DV4TD	1398	06/05>	<b>TER.V6874.83</b>	
<b>C2 / C3 / C3 Pluriel</b>					
1.1	TU1	1124	04/02>	<b>TER.V6191.89</b>	
	TU1A/L5	1124	04/05>	<b>TER.V6808.103</b>	
1.4	ET3J4 / L4	1360	12/03>10/05	<b>TER.V6191.89</b>	
	ET3J4 / L5	1360	11/05	<b>TER.V6972.91</b>	
	TU3	1360	04/02>	<b>TER.V6191.89</b>	
	TU3A/L5	1360	04/05>	<b>TER.V6808.103</b>	
1.4 HDi	DV4TD / L4	1398	04/02>10/05	<b>TER.V6874.83</b>	
1.6 16V	TU5	1587	04/02>	<b>TER.V6191.89</b>	
1.6 HDi	DV6ATED4 / L5	1560	11/05>	<b>TER.V6875.83</b>	
	DV6TED4 / F	1560	11/05>	<b>TER.V6875.83</b>	
<b>C4 NEW</b>					
1.4	ET3	1360	11/04>	<b>TER.V6488.89</b>	
1.6	TU5	1587	11/04>	<b>TER.V6488.89</b>	
1.6 HDi	DV6	1560	11/04>	<b>TER.V6875.83</b>	
2.0	EW10	1997	11/04>	<b>TER.V6332.89</b>	
	EW10A / L4	1997	11/04>	<b>TER.V6973.105</b>	
2.0 HDi	DW10	1997	11/04>	<b>TER.V6756.84</b>	
<b>C5</b>					
1.6 HDi	DV6TED4 / F	1560	09/04>	<b>TER.V6875.83</b>	
1.8 16V	EW7	1749	02/01>	<b>TER.V6332.89</b>	
2.0	EW10A / L4	1997	09/04>	<b>TER.V6973.105</b>	
2.0 16V	EW10	1997	02/01>	<b>TER.V6332.89</b>	
2.0 HDi	DW10	1997	02/01>	<b>TER.V5130.83</b>	
	DW10	1997	09/04>02/05	<b>TER.V6756.84</b>	
2.0 HPi 16V	EW10	1997	02/01>	<b>TER.V6332.89</b>	
2.2 HDi 16V	DW12	2179	02/01>	<b>TER.V5130.83</b>	
3.0 V6 24V	ES9	2946	02/01>	<b>TER.VCT1743.82</b>	
<b>C6 NEW</b>					
3.0	ES9A	2946	12/05>	<b>TER.VCT1743.82</b>	
<b>C8</b>					
2.0 16V	EW10	1997	06/02>	<b>TER.V6332.89</b>	
	EW10	1997	06/02>	<b>TER.V6488.89</b>	
2.0 HDi 16V	DW10	1997	06/02>	<b>TER.V5130.83</b>	
2.2 16V	EW12	2179	06/02>	<b>TER.V6332.89</b>	
	EW12	2179	06/02>	<b>TER.V6488.89</b>	
2.2 HDi 16V	DW12	2179	06/02>	<b>TER.V5130.83</b>	
3.0	ES9	2946	06/02>	<b>TER.VCT1743.82</b>	

## TERMOSTATOS / THERMOSTATS



# LISTE D'APPLICATIONS

APPLICATION LIST/ANWENDUNGSLISTE

VEHICULE MODEL FAHRZEUGTYP	MOTEUR ENGINE MOTOR	CYLINDRÉE ENGINE SIZE HUBRAUM	ANNÉE YEAR JAHR	NEUMARS A	PHOTOS PICTURES ZEICHNUNGEN
<b>CX</b>					
2.0	829	1995	07/79>07/82	TER.V0963.86	 0963  1275
	J6R	1995	07/82>12/89	TER.V0963.86	
	M20	1985	07/74>06/79	TER.V0963.86	
2.2	J6T	2165	07/85>07/91	TER.V0963.86	 1542  4885
	M22	2165	02/75>07/76	TER.V0963.86	
2.2 D	M22	2165	11/75>04/78	TER.V1275.78	 4947  5108
	M22	2165	05/78>06/79	TER.V0963.86	
2.3	M23	2347	01/76>07/83	TER.V0963.86	 5130  6106
2.5	M25	2500	07/83>07/89	TER.V0963.86	
2.5 D	M25	2500	02/79>07/91	TER.V0963.86	 6148  6191
<b>Evasion</b>					
1.8	XU7	1761	07/96>05/02	TER.V5108.83	 6488
1.9 TD	XUD9	1905	10/94>05/02	TER.V5130.83	
2.0	DW10	1997	08/99>05/02	TER.V5130.83	 6106  6191
	EW10	1997	07/00>05/02	TER.V6488.89	
	XU10	1998	07/94>07/96	TER.V5108.89	
	XU10	1998	08/96>05/02	TER.V5108.83	
2.0 16V	XU10	1998	10/98>05/02	TER.V4885.83	 6148  6191
2.1 TD	XUD11	2088	04/96>05/02	TER.V5130.83	
<b>LNA</b>					
1.0	XV8	954	01/84>07/86	TER.V5108.83	 5130  6106
1.1	XW7	1124	07/82>07/86	TER.V5108.83	
<b>Saxo</b>					
1.0	TU9	954	03/96>	TER.V6148.89	 6148  6191
1.1	TU1	1124	03/96>	TER.V6148.89	
	TU1	1124	09/00>	TER.V6191.89	
1.4	TU3	1360	03/96>	TER.V6148.89	 6148  6191
	TU3	1360	05/98>11/98	TER.V6106.89	
	TU3	1360	11/98>08/99	TER.V6191.89	
1.5 D	TUD5	1527	05/96>	TER.V1542.89	 6148  6191
1.6	TU5	1587	03/96>	TER.V6148.89	
	TU5	1587	09/99>	TER.V6191.89	
<b>Visa</b>					
1.0	XV8	954	11/83>07/87	TER.V5108.83	 6488
1.1	XM7	1124	07/83>06/88	TER.V5108.83	
	XW7	1124	10/78>07/88	TER.V5108.83	
1.2	129	1219	07/80>07/83	TER.V5108.83	 6488
1.4	150	1360	07/84>07/87	TER.V5108.83	
	156	1360	03/81>07/87	TER.V5108.83	
	XY7	1360	07/84>07/88	TER.V5108.83	
	XY8	1360	03/82>09/86	TER.V5108.83	
1.6	XU5	1580	10/84>07/88	TER.V5108.83	 6488
1.8 D	XUD7	1769	03/84>07/88	TER.V4947.81	
<b>Xantia</b>					
1.6	XU5	1580	08/93>07/96	TER.V5108.89	 6488
	XU5	1580	07/96>12/97	TER.V5108.83	
1.8	XU7	1761	09/93>12/97	TER.V5108.89	 6488
	XU7	1761	03/93>07/96	TER.V5108.83	
1.8 16V	XU7	1761	07/95>05/02	TER.V4885.83	 6488
1.9 D	XUD9	1905	06/93>12/97	TER.V5130.83	
1.9 SD	XUD9	1905	09/96>12/97	TER.V5130.83	 6488
	XUD9	1905	12/97>05/02	TER.V4885.83	
1.9 TD	XUD9	1905	06/93>05/02	TER.V4885.83	 6488

**TERMOSTATOS / THERMOSTATS**

**LISTE D'APPLICATIONS**

APPLICATION LIST/ANWENDUNGSLISTE

REFRIGERACION / REFRIGERATION













VEHICULE MODEL FAHRZEUGTYP	MOTEUR ENGINE MOTOR	CYLINDRÉE ENGINE SIZE HUBRAUM	ANNÉE YEAR JAHR	NEUMARS A	PHOTOS PICTURES ZEICHUNGEN
<b>...Xantia</b>					
2.0	XU10	1998	03/93>06/95	<b>TER.V5108.89</b>	
	XU10	1998	09/93>05/02	<b>TER.V5108.83</b>	
2.0 16V	XU10	1998	03/93>12/97	<b>TER.V4885.89</b>	
	XU10	1998	07/95>05/02	<b>TER.V4885.83</b>	
2.0 HDi	DW10	1997	10/98>05/02	<b>TER.V5130.83</b>	
3.0 V6 24V	ES9	2946	11/96>05/02	<b>TER.VCT1743.82</b>	
<b>XM</b>					
2.0	XU10	1998	05/89>06/94	<b>TER.V5108.89</b>	
	XU10	1998	01/90>07/01	<b>TER.V5108.83</b>	
2.0 16V	XU10	1998	07/94>07/01	<b>TER.V4885.83</b>	
2.1 D	XUD11	2138	09/89>12/90	<b>TER.V4640.85</b>	
2.5 D / TD	DJ5 / DK5	2446	02/94>	<b>TER.V5313.85</b>	
2.5 TD	DJ5 / DK5	2446	07/94>07/01	<b>TER.V5413.84</b>	
3.0 V6	ZPJ	2975	05/89>06/94	<b>TER.V4780.78</b>	
3.0 V6 24V	ZPJ	2963	07/90>06/97	<b>TER.V4780.78</b>	
<b>Xsara</b>					
1.1	TU3JP	1360	11/98>08/00	<b>TER.V6191.89</b>	
1.4	TU3	1360	07/97>08/00	<b>TER.V6148.89</b>	
	TU3	1360	09/00>	<b>TER.V6488.89</b>	
	TU3JP	1360	07/97>11/98	<b>TER.V6106.89</b>	
1.4 HDi	DV4TD / L4	1398	01/03>	<b>TER.V6874.83</b>	
1.5 D	TUD5	1527	03/98>08/00	<b>TER.V1542.89</b>	
1.6	TU5	1587	07/97>08/00	<b>TER.V6148.89</b>	
1.6 16V	TU5	1587	09/00>	<b>TER.V6488.89</b>	
1.8	XU7	1761	07/97>08/00	<b>TER.V5108.83</b>	
1.8 16V	XU7	1761	07/97>08/00	<b>TER.V4885.83</b>	
1.8 D	XUD7	1769	03/98>08/00	<b>TER.V5130.83</b>	
1.9 D	DW8	1868	09/98>	<b>TER.V5130.83</b>	
	XUD9	1905	07/97>08/00	<b>TER.V5130.83</b>	
1.9 SD	XUD9	1905	03/98>08/00	<b>TER.V5130.83</b>	
1.9 TD	XUD9	1905	07/97>08/00	<b>TER.V4885.83</b>	

## TERMOSTATOS / THERMOSTATS



# LISTE D'APPLICATIONS

APPLICATION LIST/ANWENDUNGSLISTE

VEHICULE MODEL FAHRZEUGTYP	MOTEUR ENGINE MOTOR	CYLINDRÉE ENGINE SIZE HUBRAUM	ANNÉE YEAR JAHR	NEUMARS A	PHOTOS PICTURES ZEICHNUNGEN	
<b>...Xsara</b>						
2.0 16V	EW10	1997	09/00>	<b>TER.V6332.89</b>		
	XU10	1998	01/98>	<b>TER.V4885.83</b>		
2.0 HDi	DW10	1997	03/99>	<b>TER.V5130.83</b>		
<b>Xsara Picasso</b>						
1.6	TU5	1587	12/99>	<b>TER.V6488.89</b>		
1.6 HDi	DV6TED4	1560	03/04>	<b>TER.V6875.83</b>		
1.8 16V	EW7	1749	12/99>	<b>TER.V6332.89</b>		
2.0	EW10	1997	01/03>	<b>TER.V6332.89</b>		
2.0 HDi	DW10	1997	12/99>	<b>TER.V5130.83</b>		
<b>ZX</b>						
1.1	TU1	1124	03/91>07/98	<b>TER.V6148.89</b>		
1.4	TU3	1360	03/91>07/98	<b>TER.V6148.89</b>		
1.4 D	TUD3	1360	07/94>07/98	<b>TER.V1542.89</b>		
1.5 D	TUD5	1527	07/94>07/98	<b>TER.V1542.89</b>		
1.6	XU5	1580	03/91>07/96	<b>TER.V5108.89</b>		
	XU5	1580	09/92>07/98	<b>TER.V5108.83</b>		
1.8	XU7	1761	09/92>07/96	<b>TER.V5108.89</b>		
	XU7	1761	09/92>07/98	<b>TER.V5108.83</b>		
1.8 16V	XU7	1761	03/97>07/98	<b>TER.V4885.83</b>		
1.8 D	XUD7	1769	09/92>07/98	<b>TER.V5130.83</b>		
1.9	XU9	1905	03/91>08/92	<b>TER.V5108.89</b>		
	XU9	1905	09/92>08/93	<b>TER.V5108.83</b>		
1.9 D / TD	XUD9	1905	09/92>07/98	<b>TER.V5130.83</b>		
2.0	XU10	1998	09/92>07/98	<b>TER.V5108.83</b>		
	XU10	1998	09/92>07/96	<b>TER.V5108.89</b>		
2.0 16V	XU10	1998	10/92>07/98	<b>TER.V4885.89</b>		
	XU10	1998	07/95>07/98	<b>TER.V4885.83</b>		
<b>CITROEN</b> 						
<b>Berlingo</b>						
1.1	TU1	1124	07/96>12/02	<b>TER.V6148.89</b>		
	TU1	1124	01/01>12/02	<b>TER.V6191.89</b>		
	TU1	1224	12/02>	<b>TER.V6488.89</b>		
1.4	TU3	1360	07/96>12/02	<b>TER.V6148.89</b>		
	TU3	1360	05/98>11/98	<b>TER.V6106.89</b>		
	TU3	1360	05/99>12/02	<b>TER.V6191.89</b>		
	TU3	1360	12/02>	<b>TER.V6488.89</b>		
1.6	TU5	1587	12/02>	<b>TER.V6488.89</b>		
1.6 16V	TU5	1587	12/00>12/02	<b>TER.V6191.89</b>		
1.6 HDi	DV6	1560	01/06>	<b>TER.V6875.83</b>		
1.8	XU7	1761	07/97>12/02	<b>TER.V5108.83</b>		
1.8 D	XUD7	1769	07/96>12/02	<b>TER.V5130.83</b>		
1.9 D	DW8	1868	07/98>	<b>TER.V5130.83</b>		
	XUD9	1905	07/96>12/02	<b>TER.V5130.83</b>		
2.0 HDi	DW10	1997	10/99>	<b>TER.V5130.83</b>		
<b>C15</b>						
1.0	XV8	954	11/86>05/88	<b>TER.V5108.83</b>		
	XV8 / TU9	954	05/88>06/95	<b>TER.V6148.89</b>		
1.1	E1A	1118	07/87>07/88	<b>TER.V1529.89</b>		
	TU1	1124	07/88>02/01	<b>TER.V6148.89</b>		
	XW7	1124	10/84>05/88	<b>TER.V5108.83</b>		
1.3	G1A	1294	07/87>07/88	<b>TER.V1529.89</b>		

**TERMOSTATOS / THERMOSTATS**

**LISTE D'APPLICATIONS**

APPLICATION LIST/ANWENDUNGSLISTE

REFRIGERACION / REFRIGERATION

VEHICULE MODEL FAHRZEUGTYP	MOTEUR ENGINE MOTOR	CYLINDRÉE ENGINE SIZE HUBRAUM	ANNÉE YEAR JAHR	NEUMARS A	PHOTOS PICTURES ZEICHNUNGEN	
<b>...C15</b>						
1.4	TU3	1360	07/88>02/01	<b>TER.V6148.89</b>	 0963	
	XY7	1360	07/86>05/88	<b>TER.V5108.83</b>		 2620
	XY7	1360	05/88>07/89	<b>TER.V6148.89</b>		
1.7 D	XUD7	1769	10/84>11/91	<b>TER.V4947.81</b>	 4046	
	XUD7	1769	08/89>05/92	<b>TER.V5231.83</b>		 4885
	XUD7	1769	08/89>02/01	<b>TER.V5130.83</b>		
1.9 D	DW8B	1868	03/01>	<b>TER.V5130.83</b>		
<b>C25</b>						
1.8	XM7	1796	11/81>02/94	<b>TER.V2620.82</b>		
1.9 D	XUD9	1905	12/87>02/94	<b>TER.V4945.89</b>		
2.0	XN1	1971	11/81>02/94	<b>TER.V2620.82</b>		
2.5 D / TD	U25	2500	11/81>02/94	<b>TER.V0963.86</b>		
<b>C35</b>						
2.0	B20	1985	11/73>12/91	<b>TER.V4046.86</b>		
<b>Dispatch</b>						
1.6	160	1581	09/95>12/03	<b>TER.V6541.87</b>		
1.9 D	DW8	1868	02/99>	<b>TER.V5130.83</b>		
1.9 D / TD	XUD9	1905	09/95>12/03	<b>TER.V5130.83</b>		
2.0 HDi	DW10	1997	09/00>	<b>TER.V5130.83</b>		
<b>Jumper</b>						
1.9 D	XUD9	1905	02/94>12/01	<b>TER.V5130.83</b>	 5108	
1.9 TD	XUD9	1905	02/94>12/01	<b>TER.V4885.83</b>		 5130
1.9 TD 4x4	XUD9	1905	07/97>12/01	<b>TER.V4885.83</b>		
2.0	DW10	1997	09/01>	<b>TER.V5130.83</b>	 5231	
	XU10	1998	02/94>	<b>TER.V5108.83</b>		 5309
2.0 4x4	XU10	1998	02/94>08/98	<b>TER.V5108.83</b>		
2.2	DW12	2179	01/02>	<b>TER.V5130.83</b>		
2.2 HDi	DW12	2179	01/02>	<b>TER.V5130.83</b>		
2.5 D / TD / TDi	DJ5 / DK5	2446	02/94>12/01	<b>TER.V5309.84</b>	 5313	
	DJ5 / DK5	2446	02/94>12/01	<b>TER.V5313.85</b>		 6148
2.5 D / TDi 4x4	DJ5 / DK5	2446	02/94>12/01	<b>TER.V5309.84</b>		
2.5 D 4x4	DJ5 / DK5	2446	02/94>12/01	<b>TER.V5313.85</b>		
2.8 D	8140-63	2798	06/99>12/01	<b>TER.V6581.82</b>	 6488	
2.8 HDi	8140-43S	2798	09/00>12/01	<b>TER.V6581.82</b>		 6541
	F28	2798	01/02>	<b>TER.V6581.82</b>		
<b>Jumpy</b>						
1.6	160	1581	09/95>12/03	<b>TER.V6541.87</b>		
1.9 D	DW8	1868	05/98>	<b>TER.V5130.83</b>		
1.9 D / TD	XUD9	1905	09/95>12/03	<b>TER.V5130.83</b>		
2.0	EW10	1997	09/00>	<b>TER.V6488.89</b>		
2.0 HDi	DW10	1997	09/00>	<b>TER.V5130.83</b>		
<b>Relay</b>						
1.9 D	XUD9	1905	02/94>08/98	<b>TER.V5130.83</b>	 6581	
1.9 TD	XUD9	1905	02/94>12/01	<b>TER.V4885.83</b>		
2.0	XU10	1998	02/94>	<b>TER.V5108.83</b>		
2.0 HDi	DW10	1997	01/02>	<b>TER.V5130.83</b>		
2.2 HDi	DW12	2179	01/02>	<b>TER.V5130.83</b>		
2.5 D / TD	DJ5	2446	02/94>08/98	<b>TER.V5309.84</b>		
	DJ5	2446	02/94>08/98	<b>TER.V5313.85</b>		
2.8 HDi	F28	2798	01/02>	<b>TER.V6581.82</b>		
<b>Synergie</b>						
1.8	XU7	1761	07/96>09/98	<b>TER.V5108.83</b>		
1.9 TD	XUD9	1905	10/95>05/02	<b>TER.V5130.83</b>		

## TERMOSTATOS / THERMOSTATS



# LISTE D'APPLICATIONS

APPLICATION LIST/ANWENDUNGSLISTE

VEHICULE MODEL FAHRZEUGTYP	MOTEUR ENGINE MOTOR	CYLINDRÉE ENGINE SIZE HUBRAUM	ANNÉE YEAR JAHR	NEUMARS A	PHOTOS PICTURES ZEICHNUNGEN
<b>PEUGEOT</b>					
<b>104</b>					
1.0	XV3 / 5 / 8	954	07/72>06/87	TER.V1427.82	
	XV3 / 5 / 8	954	07/72>06/87	TER.V5108.83	
	XV3 / 5 / 8	954	07/72>06/87	TER.V6148.89	
1.1	XW3 / 7	1124	07/75>05/88	TER.V1427.82	1415
	XW3 / 7	1124	07/75>05/88	TER.V5108.83	
	XW3 / 7	1124	07/75>05/88	TER.V6148.89	
1.2	XZ5	1219	07/79>06/84	TER.V1427.82	
	XZ5	1219	07/79>06/84	TER.V5108.83	
	XZ5	1219	07/79>06/84	TER.V6148.89	1427
1.3	TU2	1294	06/93>03/96	TER.V6148.89	
1.4	XY6B / XY8 / XYR	1360	08/78>07/85	TER.V1427.82	
	XY6B / XY8 / XYR	1360	08/78>07/85	TER.V5108.83	
	XY6B / XY8 / XYR	1360	08/78>07/85	TER.V6148.89	1538
<b>106</b>					
1.0	TU9	954	09/91>07/03	TER.V6148.89	
1.1	TU1	1124	09/91>07/03	TER.V6148.89	
	TU1	1124	09/00>07/03	TER.V6191.89	
1.3	TU2	1294	06/93>03/96	TER.V6148.89	
1.4	TU3	1360	03/96>07/03	TER.V6148.89	
	TU3	1360	01/98>07/03	TER.V6191.89	
	TU3	1360	05/98>11/98	TER.V6106.89	1542
1.4 D	TUD3	1360	06/92>03/96	TER.V1542.89	
1.5 D	TUD5	1527	03/96>07/03	TER.V1542.89	
1.6	TU5	1587	03/93>07/03	TER.V6148.89	4947
<b>107 / 1007 NEW</b>					
1.0	384F(CFA)	998	06/05>	TER.V6950.82	
1.4	TU3JP	1360	04/05>	TER.V6488.89	
1.4 HDi	DV4TD	1399	04/05>	TER.V6874.83	
1.6	TU5JP4	1587	04/05>	TER.V6488.89	
<b>204</b>					
1.1	XK / XK4	1130	07/65>09/70	TER.V2150.75	
	XK4 / XK5	1130	10/70>06/77	TER.V1415.75	
1.2 D	XLD	1225	09/67>06/77	TER.V1415.75	
	XLD	1225	09/67>06/77	TER.V2150.75	
1.4 D	XLD4	1357	03/73>06/77	TER.V1538.82	5130
<b>205</b>					
1.0	TU9	954	08/87>09/98	TER.V6148.89	
	XV8	954	02/83>07/88	TER.V5108.83	
1.1	E1 / F1	1118	07/84>06/93	TER.V1418.83	
	TU1	1124	08/87>09/98	TER.V6148.89	
	XW7	1124	02/83>07/88	TER.V5108.83	
1.3	G1 / G1A	1294	07/84>06/93	TER.V1418.83	
	TU2	1294	08/87>06/93	TER.V6148.89	
1.4	TU3	1360	08/87>12/94	TER.V6148.89	
	XY6B / XY7 / XY8	1360	02/83>12/94	TER.V5108.83	
	Y2 / K	1442	07/84>07/87	TER.V1418.83	
1.6	J2	1592	07/84>06/93	TER.V1418.83	
	XU5	1580	02/83>09/98	TER.V5108.83	
	XU5	1580	08/87>09/98	TER.V5108.89	
	XU5	1580	08/87>09/98	TER.V6148.89	
1.7 D	XUD7	1769	08/83>07/90	TER.V4947.81	
	XUD7	1769	07/89>05/92	TER.V5231.83	
	XUD7	1769	05/92>09/98	TER.V5130.83	
1.7 TD	XUD7T	1769	10/90>09/98	TER.V5231.83	6874
					6950 NEW

**TERMOSTATOS / THERMOSTATS**

**LISTE D'APPLICATIONS**

APPLICATION LIST/ANWENDUNGSLISTE

REFRIGERACION / REFRIGERATION

VEHICULE MODEL FAHRZEUGTYP	MOTEUR ENGINE MOTOR	CYLINDRÉE ENGINE SIZE HUBRAUM	ANNÉE YEAR JAHR	NEUMARS A	PHOTOS PICTURES ZEICHNUNGEN
<b>...205</b>					
1.9	XU9	1905	02/83>09/98	<b>TER.V5108.83</b>	
	XU9	1905	08/89>09/98	<b>TER.V5108.89</b>	
	XU9	1905	08/87>09/98	<b>TER.V6148.89</b>	
1.9 D	XUD9	1905	08/89>05/92	<b>TER.V5231.83</b>	1415
	XUD9	1905	05/92>09/98	<b>TER.V5130.83</b>	1538
<b>206 / 207</b>					
1.1	TU1	1124	09/98>	<b>TER.V6488.89</b>	
	TU1	1124	09/05>	<b>TER.V6808.103</b>	
1.4	TU3 / ET3J4	1360	09/98>	<b>TER.V6488.89</b>	1542
1.4 HDi	DV4TD / L4	1398	03/02>	<b>TER.V6874.83</b>	2150
1.6	TU5	1587	09/98>	<b>TER.V6488.89</b>	
1.6 HDi	DV6TED4	1560	04/04>	<b>TER.V6875.83</b>	
1.8 D	DW8	1761	09/98>	<b>TER.V5130.83</b>	2620
1.9 D	DW8	1868	09/98>	<b>TER.V5130.83</b>	4945
2.0 16V	EW10	1997	09/99>	<b>TER.V6332.89</b>	
2.0 HDi	DW10	1997	09/99>	<b>TER.V5130.83</b>	
<b>304</b>					
1.1	XK5	1127	09/76>09/79	<b>TER.V1415.75</b>	4947
1.3	XL3	1288	07/69>09/70	<b>TER.V2150.75</b>	5108
	XL3 / XL5	1288	09/70>09/79	<b>TER.V1415.75</b>	
	XL5	1290	09/79>03/80	<b>TER.V2620.82</b>	
1.4 D	XL4D	1357	09/76>09/79	<b>TER.V1538.82</b>	5130
1.6 D	XIDL	1548	09/79>03/80	<b>TER.V1542.82</b>	5231
<b>305</b>					
1.1	XK5	1127	11/77>02/88	<b>TER.V2620.82</b>	
1.3	XL5	1290	11/77>06/90	<b>TER.V2620.82</b>	
1.5	XR5	1472	11/77>06/90	<b>TER.V2620.82</b>	6148
1.5 D	X1D	1548	11/77>07/82	<b>TER.V1542.82</b>	6332
1.6	XU5	1580	08/82>06/90	<b>TER.V5108.83</b>	
	XU5	1580	08/82>06/90	<b>TER.V6148.89</b>	
1.7 D	XUD7	1769	08/82>06/90	<b>TER.V4945.89</b>	6488
	XUD7	1769	08/82>06/90	<b>TER.V4947.81</b>	6808
1.9	XU9	1905	08/82>06/90	<b>TER.V5108.83</b>	
	XU9	1905	08/82>06/90	<b>TER.V6148.89</b>	
1.9 D	XUD9	1905	08/82>06/90	<b>TER.V4945.89</b>	
	XUD9	1905	08/82>06/90	<b>TER.V4947.81</b>	
<b>306</b>					
1.1	TU1	1124	02/93>02/97	<b>TER.V6148.89</b>	6874
					6875



























## TERMOSTATOS / THERMOSTATS



# LISTE D'APPLICATIONS

APPLICATION LIST/ANWENDUNGSLISTE

VEHICULE MODEL FAHRZEUGTYP	MOTEUR ENGINE MOTOR	CYLINDRÉE ENGINE SIZE HUBRAUM	ANNÉE YEAR JAHR	NEUMARS A	PHOTOS PICTURES ZEICHNUNGEN	
<b>...306</b>						
1.4	TU3	1360	02/93>03/02	TER.V6148.89	 1418	
	TU3	1360	05/99>03/02	TER.V6191.89		 1529
1.6	TU5	1587	02/93>05/99	TER.V6148.89	 4885	
	TU5	1587	05/99>09/02	TER.V6191.89		 4949
	TU5	1587	01/00>09/02	TER.V6488.89		
1.8	XU7	1761	02/93>07/96	TER.V5108.89	 5108	
	XU7	1761	06/93>09/02	TER.V5108.83		 5130
1.8 16V	XU7	1761	03/97>09/02	TER.V4885.83	 5229	
1.8 D	XUD7	1769	06/93>02/02	TER.V5130.83		 5231
1.9 D	DW8	1868	11/98>03/02	TER.V5130.83	 6148	
1.9 D / SD	XUD9	1905	06/93>03/02	TER.V5130.83		 6191
1.9 TD	XUD9T	1905	06/93>02/97	TER.V5130.83	 6332	
	XUD9T	1905	03/97>03/02	TER.V4885.83		 6488
2.0	XU10	1998	06/93>07/96	TER.V5108.89	 6756	
	XU10	1998	09/93>02/97	TER.V5108.83		 6874
	XU10	1998	09/93>02/97	TER.V4885.89		
	XU10	1998	03/96>09/02	TER.V4885.83		
2.0 HDi	DW10	1997	03/99>03/02	TER.V5130.83		
<b>307</b>						
1.4	TU3	1360	09/01>	TER.V6488.89		
1.4 HDi	DV4TED4	1398	04/02>	TER.V6874.83		
1.6 16V	TU5	1587	03/01>	TER.V6488.89		
1.6 HDi	DV6TED4	1560	04/04>	TER.V6875.83		
2.0 16V	EW10	1997	03/01>	TER.V6332.89		
2.0 HDi	DW10	1997	03/01>	TER.V5130.83		
	DW10	1997	09/05>	TER.V6756.84		
<b>309</b>						
1.1	E1	1118	09/85>07/92	TER.V1529.89	 6332	
	TU1	1124	08/89>08/93	TER.V6148.89		 6488
1.3	G1A / G1B / G2 / G2S	1294	09/85>07/92	TER.V1529.89	 6756	
	G1A / G2	1294	08/86>07/89	TER.V1418.83		 6874
1.4	TU3	1360	08/88>08/94	TER.V6148.89	 6875	
1.5	Y2 / K	1442	08/86>07/90	TER.V1529.89		 6874
	Y2 / K	1442	08/90>07/92	TER.V1418.83		
1.6	J2	1592	08/86>07/90	TER.V1529.89	 6874	
	J2	1592	08/90>07/92	TER.V1418.83		
	XU5	1580	08/85>08/93	TER.V6148.89		
	XU5	1580	08/89>08/93	TER.V5108.89		
1.7 D	XUD7	1769	08/86>05/92	TER.V5231.83	 6875	
	XUD7	1769	05/92>08/94	TER.V5130.83		
1.7 TD	XUD7T	1769	08/89>08/93	TER.V4949.89	 6875	
	XUD7T	1769	08/89>08/93	TER.V5229.83		
1.9	XU9	1905	09/85>08/93	TER.V6148.89	 6875	
	XU9	1905	08/89>08/93	TER.V5108.89		



# LISTE D'APPLICATIONS

APPLICATION LIST/ANWENDUNGSLISTE

REFRIGERACION / REFRIGERATION

VEHICULE MODEL FAHRZEUGTYP	MOTEUR ENGINE MOTOR	CYLINDRÉE ENGINE SIZE HUBRAUM	ANNÉE YEAR JAHR	NEUMARS A	PHOTOS PICTURES ZEICHNUNGEN
<b>...309</b>					
1.9 16S	XU9	1905	08/89>08/93	<b>TER.V1538.88</b>	
1.9 D	XUD9	1905	08/86>08/93	<b>TER.V5231.83</b>	
	XUD9	1905	05/92>08/93	<b>TER.V5130.83</b>	
<b>404</b>					
1.5	XB2 / 5	1468	06/62>07/70	<b>TER.V1414.75</b>	
1.6	KF2 / XC / 5 / 6 / 7	1618	04/60>05/79	<b>TER.V1414.75</b>	
1.8	XMU6S	1796	01/70>10/70	<b>TER.V1414.75</b>	
1.8 D	XD85	1816	06/62>06/63	<b>TER.V1413.72</b>	
1.9 D	XD88	1948	07/63>06/77	<b>TER.V1413.72</b>	
2.0 D	XDP88	1984	09/72>05/79	<b>TER.V1413.72</b>	
<b>405</b>					
1.4	TU3	1360	06/87>10/96	<b>TER.V6148.89</b>	
1.6	XU5	1580	06/87>06/92	<b>TER.V6148.89</b>	
	XU5	1580	06/89>10/96	<b>TER.V5108.89</b>	
	XU5	1580	07/92>10/96	<b>TER.V5108.83</b>	
1.7 D	XUD7	1769	06/90>05/92	<b>TER.V5231.83</b>	
	XUD7	1769	06/92>06/92	<b>TER.V5130.83</b>	
1.7 TD	XUD7T	1769	06/87>05/92	<b>TER.V5231.83</b>	
	XUD7T	1769	06/88>05/89	<b>TER.V1413.72</b>	
	XUD7T	1769	06/92>06/92	<b>TER.V5130.83</b>	
	XUD7T	1769	07/93>10/95	<b>TER.V6875.83</b>	
1.8	XU7	1761	07/92>10/96	<b>TER.V5108.83</b>	
	XU7	1761	07/92>10/96	<b>TER.V5108.89</b>	
1.9	XU9	1905	06/87>06/92	<b>TER.V1538.88</b>	
	XU9	1905	06/87>06/92	<b>TER.V6148.89</b>	
	XU9	1905	06/88>10/96	<b>TER.V5108.89</b>	
	XU9	1905	07/92>10/96	<b>TER.V5108.83</b>	
1.9 D	XUD9	1905	06/87>05/92	<b>TER.V5231.83</b>	
1.9 D / TD	XUD9	1905	06/92>10/96	<b>TER.V5130.83</b>	
2.0	XU10	1998	07/92>10/95	<b>TER.V4885.89</b>	
	XU10	1998	07/92>10/96	<b>TER.V5108.83</b>	
	XU10	1998	07/92>10/96	<b>TER.V5108.89</b>	
2.0 Turbo 16	XU10	1998	02/92>10/95	<b>TER.V1468.82</b>	
<b>406</b>					
1.6	XU5	1580	10/95>03/99	<b>TER.V5108.89</b>	
	XU5	1580	07/96>03/04	<b>TER.V5108.83</b>	
1.8	EW7	1749	10/00>04/04	<b>TER.V6332.89</b>	
	XU7	1761	10/95>04/04	<b>TER.V5108.83</b>	
	XU7	1761	10/95>07/96	<b>TER.V5108.89</b>	
1.8 16V	XU7	1761	10/95>04/04	<b>TER.V4885.83</b>	
1.9 TD	XUD9T	1905	11/95>03/99	<b>TER.V5130.83</b>	
2.0 16V	EW10	1998	04/99>10/04	<b>TER.V6332.89</b>	
	XU10	1998	10/95>04/04	<b>TER.V4885.83</b>	
2.0 HDi	DW10	1997	10/98>04/04	<b>TER.V5130.83</b>	
2.0 Turbo	XU10	1998	07/96>03/99	<b>TER.V5108.83</b>	
2.2 16V	EW12	2230	05/00>10/04	<b>TER.V6332.89</b>	
2.2 HDi	DW12	2179	10/00>10/04	<b>TER.V5130.83</b>	
3.0 V6 24V	ES9J4	2946	10/96>10/04	<b>TER.VCT1743.82</b>	
<b>407</b>					
1.6 HDi	DV6TED4	1560	04/04>	<b>TER.V6875.83</b>	
1.8 16V	EW7	1749	04/04>	<b>TER.V6332.89</b>	
2.0	EW10	1997	04/04>	<b>TER.V6332.89</b>	
2.0 HDi	DW10	1997	04/04>	<b>TER.V5130.83</b>	
2.2 16V	EW12	2230	04/04>	<b>TER.V6332.89</b>	



## TERMOSTATOS / THERMOSTATS



# LISTE D'APPLICATIONS

APPLICATION LIST/ANWENDUNGSLISTE

VEHICULE MODEL FAHRZEUGTYP	MOTEUR ENGINE MOTOR	CYLINDRÉE ENGINE SIZE HUBRAUM	ANNÉE YEAR JAHR	NEUMARS A	PHOTOS PICTURES ZEICHNUNGEN
<b>...407</b>					
3.0 V6 24V	ES9	2946	04/04>	TER.VCT1743.82	 1183
<b>504</b>					
1.6	XC7	1618	08/79>07/85	TER.V1414.75	 1414
	XC7	1618	08/79>07/85	TER.V2620.75	
1.8	KF5 / 6	1796	06/68>07/70	TER.V1414.75	 1418
	XM / XM7	1796	06/68>09/93	TER.V1414.75	 1503
	XM7	1796	08/70>09/93	TER.V2620.75	
1.9 D	XD88	1948	08/70>07/83	TER.V1503.78	 2620
	XD88	1948	08/83>07/85	TER.V1503.72	 4640
2.0	XN1 / XN2 / XNA	1971	09/69>12/00	TER.V1414.75	 4885
	XN1 / XN2 / XNA	1971	09/69>12/00	TER.V2620.75	 4947
2.1 D	XD4 / XD90	2112	06/69>07/85	TER.V1503.78	 5108
	XD4 / XD90	2112	08/83>07/85	TER.V1503.72	 5313
2.3 D	XD2	2304	08/71>07/83	TER.V1503.78	 5413
	XD2	2304	08/83>07/96	TER.V1503.72	 CT1743
2.5 D	XD3	2498	08/85>09/93	TER.V1503.72	
2.7 V6	ZMI / ZMJ	2664	09/74>07/84	TER.V1183.83	
<b>505</b>					
1.6	XC7	1618	08/83>07/84	TER.V2620.75	
1.8	XM7	1796	05/79>12/90	TER.V2620.82	
2.0	XN1	1971	05/79>12/90	TER.V2620.82	
	XN6	1971	08/82>07/88	TER.V2620.75	
	ZEJ	1995	05/79>12/90	TER.V1183.83	
2.2	ZDJK / JL	2165	08/81>12/90	TER.V1183.83	
2.2 / T	N9T / NT9E	2155	08/82>12/90	TER.V1418.83	
2.3 D	XD2	2304	08/79>07/81	TER.V1503.72	
	XD2	2304	07/81>07/85	TER.V1503.78	
2.3 TD	XD2S	2304	08/80>	TER.V1503.80	
	XD2S	2304	08/80>07/85	TER.V4947.81	
2.5 D / TD	XD3	2498	08/79>12/90	TER.V4947.81	
2.8 V6	ZN3J / ZNJK	2849	08/85>12/90	TER.V1183.83	
<b>604</b>					
2.0	XN6	1971	07/82>12/84	TER.V2620.82	
2.3 TD	XD2S	2304	02/79>12/85	TER.V1503.80	
2.5 TD	XD3T	2498	09/83>12/86	TER.V4947.81	
2.7 V6	ZM / ZMJ	2664	03/76>12/85	TER.V1183.83	
2.8 V6	ZNJ	2849	09/83>12/86	TER.V1183.83	
<b>605</b>					
2.0	XU10	1998	10/89>05/99	TER.V5108.89	
	XU10	1998	01/93>05/99	TER.V5108.83	
2.0 16V	XU10	1998	07/94>05/99	TER.V4885.83	
2.1 D	XUD11	2138	09/90>12/90	TER.V4640.85	
2.5 TD	DK5ATE	2446	07/94>05/99	TER.V5313.85	
	DK5ATE	2446	07/94>05/99	TER.V5413.84	

**TERMOSTATOS / THERMOSTATS**

**LISTE D'APPLICATIONS**

APPLICATION LIST/ANWENDUNGSLISTE

REFRIGERACION / REFRIGERATION

VEHICULE MODEL FAHRZEUGTYP	MOTEUR ENGINE MOTOR	CYLINDRÉE ENGINE SIZE HUBRAUM	ANNÉE YEAR JAHR	NEUMARS A	PHOTOS PICTURES ZEICHUNGEN
<b>...605</b>					
3.0 V6	ZPJ / ZPJ4	2975	10/89>05/99	<b>TER.V4780.78</b>	 2620
3.0 V6 24V	ES9J4	2946	06/97>05/99	<b>TER.VCT1743.82</b>	
<b>607</b>					
2.0 16V	EW10	1997	05/00>09/04	<b>TER.V6332.89</b>	 4780
2.0 HDi	DW10	1997	05/00>	<b>TER.V5130.83</b>	
2.2 16V	EW12	2230	05/00>	<b>TER.V6332.89</b>	 4885
2.2 HDi 16V	DW12	2179	05/00>	<b>TER.V5130.83</b>	
3.0 V6 24V	ES9	2946	05/00>	<b>TER.VCT1743.82</b>	 4945
<b>806</b>					
1.8	XU7	1761	06/95>07/96	<b>TER.V5108.89</b>	 5108
	XU7	1761	07/96>05/02	<b>TER.V5108.83</b>	
1.9 TD	XUD9	1905	08/94>05/02	<b>TER.V5130.83</b>	 5130
2.0	EW10	1997	07/00>05/02	<b>TER.V6488.89</b>	
	EW10	1997	06/02>	<b>TER.V6332.89</b>	
	XU10	1998	07/94>07/96	<b>TER.V5108.89</b>	
2.0 16V	XU10	1998	10/98>05/02	<b>TER.V4885.83</b>	 5309
2.0 HDi	DW10	1997	08/99>	<b>TER.V5130.83</b>	
2.1 TD	XUD11	2088	06/96>05/02	<b>TER.V5130.83</b>	 5313
2.2	EW12	2230	06/02>09/05	<b>TER.V6332.89</b>	
2.2 HDi	DW12	2179	06/02>	<b>TER.V5130.83</b>	 5413
3.0	ES9J	2946	06/02>09/05	<b>TER.VCT1743.82</b>	
<b>807</b>					
2.0 16V	EW10	1997	06/02>	<b>TER.V6332.89</b>	 6332
2.0 HDi 16V	DW10	1997	06/02>	<b>TER.V5130.83</b>	
2.2 16V	EW12	2230	06/02>	<b>TER.V6332.89</b>	 6488
2.2 HDi 16V	DW12	2179	06/02>02/04	<b>TER.V5130.83</b>	
3.0	ES9	2946	06/02>	<b>TER.VCT1743.82</b>	 6541

**PEUGEOT**

**Boxer**

1.9 D	XUD9	1905	02/94>12/01	<b>TER.V5130.83</b>
1.9 TD	XUD9T / XUD9U	1905	02/94>12/01	<b>TER.V4885.83</b>
2.0	XU10	1998	02/94>	<b>TER.V5108.83</b>
2.0 HDi	DW10	1997	09/01>	<b>TER.V5130.83</b>
2.2 HDi	DW12	2179	01/02>	<b>TER.V5130.83</b>
2.5 D	DJ5	2446	02/94>12/01	<b>TER.V5309.84</b>
	DJ5	2446	02/94>12/01	<b>TER.V5313.85</b>
	DJ5T	2446	02/94>12/01	<b>TER.V5309.84</b>
2.5 TD / TDi	DJ5T	2446	02/94>12/01	<b>TER.V5313.85</b>
	DJ5T	2446	02/94>12/01	<b>TER.V5413.84</b>
	DJ5T	2446	02/94>12/01	<b>TER.V5413.84</b>
2.8 D / TD	8140-63 / 8140-43	2798	06/99>12/01	<b>TER.V6581.82</b>
2.8 HDi	8140-43S / F28T	2798	09/00>	<b>TER.V6581.82</b>

**Expert**

1.6	160A	1581	09/95>12/03	<b>TER.V6541.87</b>
1.8	XU7	1761	07/96>12/03	<b>TER.V5108.83</b>
1.9 D	DW8	1868	05/98>	<b>TER.V5130.83</b>
1.9 D / TD	XUD9	1905	09/95>12/03	<b>TER.V5130.83</b>
2.0	EW10	1997	09/00>	<b>TER.V6488.89</b>
2.0 HDi	DW10	1997	09/00>	<b>TER.V5130.83</b>

**J5**

1.8	XM7T	1796	11/81>08/90	<b>TER.V2620.75</b>
	XM7T	1796	11/81>02/94	<b>TER.V2620.82</b>
1.9 D	XUD9	1905	07/87>02/94	<b>TER.V4945.89</b>



2620



4780



4885



4945



5108



5130



5309



5313



5413



6332



6488



6541



6581



















CT1743

## TERMOSTATOS / THERMOSTATS



# LISTE D'APPLICATIONS

APPLICATION LIST/ANWENDUNGSLISTE

VEHICULE MODEL FAHRZEUGTYP	MOTEUR ENGINE MOTOR	CYLINDRÉE ENGINE SIZE HUBRAUM	ANNÉE YEAR JAHR	NEUMARS A	PHOTOS PICTURES ZEICHNUNGEN
<b>...J5</b>					
1.9 TD	M705	1929	09/90>02/94	<b>TER.V5687.80</b>	
2.0	XN1T	1971	11/81>08/90	<b>TER.V2620.75</b>	
	XN1T	1971	11/81>02/94	<b>TER.V2620.82</b>	
2.5 D / TD	CRD93	2500	11/81>02/94	<b>TER.V0963.86</b>	
<b>J7</b>					
1.5	XB5P	1468	06/65>07/70	<b>TER.V1414.75</b>	
1.6	XC5P / XC7P	1618	09/65>08/79	<b>TER.V1414.75</b>	
1.8	XM7P	1796	07/70>01/80	<b>TER.V1414.75</b>	
1.8 D	XDP85	1816	06/65>09/67	<b>TER.V1413.72</b>	
2.0 D	XDP88	1984	09/65>07/78	<b>TER.V1413.72</b>	
2.1 D	XDP90	2112	09/67>01/80	<b>TER.V1413.72</b>	
2.3 D	XD2P94	2304	07/77>01/80	<b>TER.V1413.72</b>	
<b>J9</b>					
1.6	XC7P	1618	01/80>09/91	<b>TER.V1414.75</b>	
2.0	XN1P	1971	01/80>09/91	<b>TER.V1414.75</b>	
2.1 D	XDP90	2112	01/80>07/90	<b>TER.V1413.72</b>	
2.3 D	XD2P	2304	01/80>07/82	<b>TER.V1413.72</b>	
2.5 D	XD3P	2498	08/82>09/91	<b>TER.V3327.81</b>	
<b>P4</b>					
2.3 D	XN8	2298	01/86>	<b>TER.V2620.82</b>	
2.5 D / TD	XD3	2498	01/86>	<b>TER.V4947.81</b>	
<b>Partner</b>					
1.1	TU1	1124	06/96>11/02	<b>TER.V6148.89</b>	
	TU1	1124	01/01>11/02	<b>TER.V6191.89</b>	
	TU1	1124	11/02>	<b>TER.V6488.89</b>	
1.4	TU3	1360	06/96>11/02	<b>TER.V6148.89</b>	
	TU3	1360	05/98>11/98	<b>TER.V6106.89</b>	
	TU3	1360	11/98>11/02	<b>TER.V6191.89</b>	
	TU3	1360	11/02>	<b>TER.V6488.89</b>	
1.6	TU5	1587	09/00>11/02	<b>TER.V6191.89</b>	
	TU5	1587	11/02>	<b>TER.V6488.89</b>	
1.6 HDi	DV6	1560	09/05>	<b>TER.V6875.83</b>	
1.8	XU7	1761	05/97>11/02	<b>TER.V5108.83</b>	
1.8 D	XUD7	1769	06/96>11/02	<b>TER.V5130.83</b>	
1.9 D	DW8	1868	10/98>	<b>TER.V5130.83</b>	
	XUD9	1905	06/96>11/02	<b>TER.V5130.83</b>	
2.0 HDi	DW10	1997	05/00>	<b>TER.V5130.83</b>	
<b>Ranch</b>					
1.4	TU3	1360	06/96>05/99	<b>TER.V6148.89</b>	
	TU3	1360	05/99>	<b>TER.V6191.89</b>	
1.8	XU7	1761	07/97>11/02	<b>TER.V5108.83</b>	
1.8 D	XUD7	1769	06/96>11/02	<b>TER.V5130.83</b>	
1.9 D	DW8	1868	11/98>11/02	<b>TER.V5130.83</b>	
	XUD9	1905	06/96>	<b>TER.V5130.83</b>	
2.0 HDi	DW10	1997	01/01>	<b>TER.V5130.83</b>	
					

0963

1400

1413

1414

1439

2620

3327

4947

5108

5130

5687

6106

6148

6191

6488

6875



# CORRESPONDANCES

CROSS REFERENCES/CROSS LIST

OE	NEUMARS A	OE	NEUMARS A	OE	NEUMARS A
<b>CITROEN</b>					
1336-F9	TER.V5313.85	96050286	TER.V 5108.89	1338024	TER.V 1439.80
<b>1336-J1</b>	TER.V6541.87	96057136	TER.V 6148.89	1338-03	TER.V 1538.88
<b>1336-N1</b>	TER.V6106.89	96080220	TER.V 4780.78	1338-04	TER.V4945.89
<b>1336-Q1</b>	TER.V6488.89	96095011	TER.V 5130.83	1338-08	TER.V4945.89
<b>1336-Q2</b>	TER.V6191.89	96101599	TER.V 4780.78	1338-11	TER.V 5108.89
<b>1336-V6</b>	TER.V6874.83	96108092	TER.V 4885.89	1338-12	TER.V4640.85
<b>1336-X2</b>	TER.V6875.83	96159513	TER.V 5231.83	1338-14	TER.V4780.78
1337-47	TER.V2620.82	96160901	TER.V 5130.83	1338-16	TER.V4949.89
1337-65	TER.V0963.86	9617178080	TER.V 5108.89	1338-18	TER.V4780.78
1337-97	TER.V1529.89	97517097	TER.V 1529.89	1338-20	TER.V4947.81
1338-03	TER.V1538.88	<b>PEUGEOT</b>		1338-21	TER.V 1542.89
1338-04	TER.V4945.89	1336-A7	TER.V 5687.80	1338-23	TER.V 5130.83
1338-11	TER.V5108.89	1336-F9	TER.V 5313.85	1338-24	TER.V 5229.83
1338-12	TER.V4640.85	1336-J1	TER.V 6541.87	1338-25	TER.V 5231.83
1338-18	TER.V4780.78	1336-N1	TER.V 6106.89	1338-26	TER.V 4885.89
1338-20	TER.V4947.81	1336-N5	TER.V 6488.89	1338-36	TER.V 1468.82
1338-21	TER.V1542.89	1336-Q1	TER.V 6488.89	1338-37	TER.V 5108.83
1338-23	TER.V5130.83	1336-Q2	TER.V 6191.89	1338-38	TER.V 5309.84
1338-25	TER.V5231.83	1336-V6	TER.V 6874.83	1338-39	TER.V 4885.83
1338-26	TER.V4885.89	1336-X1	TER.V 6756.84	1338-44	TER.V 6148.89
1338-37	TER.V5108.83	1336-X2	TER.V 6875.83	1338-46	TER.V 5413.84
1338-38	TER.V5309.84	1336-Z0	TER.V 6972.91	1338-73	TER.V CT1743.82
1338-39	TER.V4885.83	1336-Z2	TER.V 6808.103	1338-83	TER.V 5108.83
1338-44	TER.V6148.89	1337-18	TER.V 2150.75	1338-90	TER.V 6581.82
1338-46	TER.V5413.84	1337-20	TER.V 1415.75	1338-A0	TER.V 6332.89
1338-73	TER.VCT1743.82	1337-25	TER.V 1413.72	1338-E4	TER.V 6973.105
1338-90	TER.V6581.82	1337-26	TER.V 1414.75	1338-E8	TER.V 6950.82
1338-A0	TER.V6332.89	1337-27	TER.V 6148.89	91500723	TER.V 2620.82
1338-C8	TER.V1542.89	1337-30	TER.V 5108.83	96005005	TER.V 4945.89
7910011880	TER.V 1417.88	1337-34	TER.V 1183.83	96006231	TER.V 1542.89
7910016560	TER.V 1417.82	1337-35	TER.V 1427.82	96020348	TER.V 1538.88
90606231	TER.V1542.89	1337-40	TER.V 1503.72	96041919	TER.V 4640.85
91500723	TER.V2620.82	1337-47	TER.V 2620.82	96049156	TER.V 5108.89
93501145	TER.V4947.81	1337-48	TER.V 1538.82	96050286	TER.V 5108.89
95492897	TER.V1275.78	1337-49	TER.V 2620.75	96057136	TER.V 6148.89
95495311	TER.V0963.86	1337-53	TER.V 1418.83	96095011	TER.V 5130.83
95517097	TER.V 1529.89	1337-54	TER.V 1542.82	96108092	TER.V 4885.89
95588361	TER.V4046.86	1337-59	TER.V 1503.80	96160901	TER.V 5130.83
95588362	TER.V4046.86	1337-64	TER.V4947.81	97517097	TER.V 1529.89
96005005	TER.V4945.89	1337-65	TER.V0963.86		
96006231	TER.V1542.89	1337-66	TER.V 1503.78		
96020348	TER.V 1538.88	1337-68	TER.V3327.81		
96041919	TER.V4640.85	1337-97	TER.V 1529.89		
96049156	TER.V5108.89				